



# Gx Series

User manual



**TABLE OF CONTENTS**

1. PRECAUTIONS AND SAFETY MEASURES .....3

1.1. Preliminary instructions ..... 3

1.2. During use ..... 4

1.3. After use ..... 4

1.4. Definition of measurement (overvoltage) category ..... 4

2. GENERAL DESCRIPTION ..... 5

2.1. Foreword ..... 5

2.2. Instrument functions ..... 6

3. PREPARATION FOR USE .....7

3.1. Initial checks ..... 7

3.2. Instrument power supply ..... 7

3.3. Storage ..... 7

4. NOMENCLATURE ..... 8

4.1. Instrument description ..... 8

4.2. Description of measuring leads ..... 8

4.3. Keyboard description ..... 9

4.4. Display description ..... 9

4.5. Initial screen ..... 9

5. GENERAL MENU ..... 10

5.1. Instrument settings ..... 10

5.1.1. Language ..... 10

5.1.2. Reference country ..... 11

5.1.3. Automatic Power OFF for display and key sound ..... 11

5.1.4. System ..... 11

5.1.5. Operator name entry ..... 11

5.1.6. System date/time setting ..... 12

5.1.7. Information ..... 12

6. OPERATING INSTRUCTIONS ..... 13

6.1. RPE: Continuity of protective conductors ..... 13

6.1.1. Anomalous situations ..... 17

6.2. MΩ: Measurement of insulation resistance ..... 18

6.2.1. AUTO or L-PE Timer mode ..... 20

6.2.2. AUTO L/N-PE mode ..... 22

6.2.3. Anomalous situations ..... 24

6.3. RCD: Test on differential switches ..... 25

6.3.1. AUTO mode ..... 29

6.3.2. AUTO+  mode ..... 30

6.3.3. x<sup>1/2</sup>, x1, x2, x5 modes ..... 31

6.3.4. Mode x1 – Test on RCDs with delay time ..... 31

6.3.5. Mode  ..... 32

6.3.6. Test on earth leakage relay RCD ..... 33

6.3.7. Anomalous situations ..... 34

6.4. LOOP: Line impedance/Loop and overall earth resistance ..... 37

6.4.1. Test types ..... 39

6.4.2. Test leads calibration (ZEROLoop) ..... 41

6.4.3. STD Mode – Generic test ..... 43

6.4.4. Mode kA – Verify of breaking capacity of protection device ..... 44

6.4.5. Mode I<sup>2</sup>t – Verify of protection against short-circuit ..... 46

6.4.6. Mode  - Verify of protection coordination ..... 49

6.4.7. Mode  - Verify of protection coordination – Norway country ..... 51

6.4.8. Verify of protection against indirect contacts (TN system) ..... 53

6.4.9. Verify of protection against indirect contacts (NoTrip  test) ..... 55

6.4.10. Verify of protection against indirect contacts (No Trip test – UK Country) ..... 57

6.4.11. Verify of protection against indirect contacts (IT systems) ..... 59

6.4.12. Verify of protection against indirect contacts (TT systems) ..... 60

6.4.13. Impedance measurement by means of the accessory IMP57 ..... 62

6.4.14. Anomalous situations ..... 64

6.5.	SEQ: Phase sequence and phase concordance test.....	66
6.5.1.	Anomalous situations.....	69
6.6.	LEAKAGE: Leakage current measurement.....	70
6.7.	EARTH: Measurement of earth resistance.....	72
6.7.1.	3-wire or 2-wire earth measurement and 4-wire ground resistivity.....	72
6.7.2.	3-wire or 2-wire earth measure – USA, Extra Europe and Germany countries.....	78
6.7.3.	Earth measurement with optional clamp T2100.....	81
6.7.4.	Anomalous situations in 3-wire and 2-wire earth measurements.....	84
6.8.	AUX: Measure of ambient parameters via external probes.....	85
6.9.	$\Delta V\%$ : Voltage drop of main lines.....	87
6.9.1.	Anomalous situations.....	91
6.10.	AUTO TEST: automatic test sequence (NoTrip $\frac{1}{T}$ , RCD, $M\Omega$ ).....	93
6.10.1.	AutoTest in TT systems.....	94
6.10.2.	AutoTest in TN systems.....	96
6.10.3.	Anomalous situations.....	98
6.11.	PQA: Real time measurement of main parameters.....	101
6.12.	EVSE: Safety test for electric car charging stations.....	104
7.	OPERATIONS WITH THE MEMORY.....	124
7.1.	Saving measurements.....	124
7.2.	Recalling measurements and deleting the memory.....	125
7.2.1.	Anomalous situations.....	126
8.	CONNECTING THE INSTRUMENT TO A PC OR MOBILE DEVICES.....	127
8.1.	Connection to iOS/Android devices through WiFi.....	127
9.	USE OF STRAP SET.....	128
10.	MAINTENANCE.....	131
10.1.	General information.....	131
10.2.	Replacement of the batteries.....	131
10.3.	Cleaning the instrument.....	131
10.4.	End of life.....	131
11.	TECHNICAL SPECIFICATIONS.....	132
11.1.	Technical characteristics.....	132
11.2.	Reference guidelines.....	137
11.3.	General characteristics.....	137
11.4.	Environment.....	137
11.4.1.	Environmental conditions for use.....	137
11.5.	Accessories.....	137
12.	SERVICE.....	138
12.1.	Warranty conditions.....	138
12.2.	Service.....	138
13.	THEORETICAL APPENDIXES.....	139
13.1.	Continuity of protective conductors.....	139
13.2.	Insulation resistance.....	140
13.3.	Checking circuit separation.....	141
13.4.	Test on differential switches (RCD).....	143
13.5.	Verify of the breaking capacity of protection devices.....	144
13.6.	Verify of protection against indirect contacts in TN systems.....	145
13.7.	No trip test in TN systems.....	147
13.8.	Verify of protection against indirect contacts in TT systems.....	148
13.9.	Verify of protection against indirect contacts in IT systems.....	149
13.10.	Verify of protection coordination L-L, L-N and L-PE.....	150
13.11.	Verify of the protection against short circuits – Test $I_{2t}$ .....	152
13.12.	Verification of voltage drop on main lines.....	153
13.13.	Measurement of earth resistance in TN systems.....	154
13.14.	Voltage and current Harmonics.....	159
13.14.1.	Presence of harmonics: causes.....	160
13.14.2.	Presence of harmonics: consequences.....	161
13.15.	Calculation of powers and power factors.....	162

## 1. PRECAUTIONS AND SAFETY MEASURES

The models of the Gx Series have been designed in compliance with Directives IEC/EN61557 and IEC/EN61010, relevant to electronic measuring instruments. Before and after carrying out the measurements, carefully observe the following instructions:

- Do not carry out any voltage or current measurement in humid environments.
- Do not carry out any measurements in case gas, explosive materials or flammables are present, or in dusty environments.
- Avoid any contact with the circuit being measured if no measurements are being carried out.
- Avoid contact with exposed metal parts, with unused measuring probes, etc.
- Do not carry out any measurement in case you find anomalies in the instrument such as deformations, breaks, substance leaks, absence of display on the screen, etc.
- Pay special attention when measuring voltages higher than 25V in special environments (such as construction sites, swimming pools, etc.) and higher than 50V in normal environments, since a risk of electrical shock exists.
- Only use original accessories.

The following symbols are used in this manual:



CAUTION: observe the instructions given in this manual; improper use could damage the instrument, its components or create dangerous situations for the operator.



High voltage danger: electrical shock hazard.



Double insulation



AC voltage or current



DC voltage or current



Connection to earth

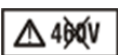

The symbol indicates that the instrument must not be connected to systems with phase-to-phase rated delta voltage higher than 415V.

### 1.1. PRELIMINARY INSTRUCTIONS

- This instrument has been designed for use in the environmental conditions specified in § 11.4.1. Do not use in different environmental conditions.
- The instrument may be used for measuring and verifying the safety of electrical systems. Do not use on systems exceeding the limit values specified in § 11
- We recommend following the normal safety rules devised to protect the user against dangerous currents and the instrument against incorrect use.
- Only the accessories supplied with the instrument guarantee compliance with safety standards. They must be in good conditions and be replaced with identical models, when necessary.
- Make sure the batteries are correctly installed.
- Before connecting the test leads to the circuit being measured, check that the desired function has been selected



## 1.2. DURING USE

Please carefully read the following recommendations and instructions:



### CAUTION

Failure to comply with the caution notes and/or instructions may damage the instrument and/or its components or be a source of danger for the operator.

- Before changing function, disconnect the test leads from the circuit under test.
- When the instrument is connected to the circuit under test, never touch any terminal, even if unused.
- Avoid measuring resistance if external voltages are present. Even if the instrument is protected, excessive voltage could cause damage.
- While measuring current, place the clamp jaws as far as possible from the conductors not involved in the measurement, as the magnetic field they produce could interfere with the measuring operations and place the conductor as much as possible in the center of the jaws to maximize accuracy.

## 1.3. AFTER USE

When measurements are completed, turn off the instrument by pressing and holding the **ON/OFF** key for some seconds. If the instrument is not to be used for a long time, remove the batteries and follow the instructions given in § 3.3.

## 1.4. DEFINITION OF MEASUREMENT (OVERVOLTAGE) CATEGORY

Standard "IEC/EN61010-1: Safety requirements for electrical equipment for measurement, control and laboratory use, Part 1: General requirements" defines what measurement category, commonly called overvoltage category, is. § 6.7.4: Measured circuits, reads: circuits are divided into the following measurement categories:

- **Measurement category IV** is for measurements performed at the source of a low-voltage installation.  
*Examples are electricity meters and measurements on primary overcurrent protection devices and ripple control units.*
- **Measurement category III** is for measurements performed on installations inside buildings.  
*Examples are measurements on distribution boards, circuit breakers, wiring, including cables, bus-bars, junction boxes, switches, socket-outlets in fixed installation, and equipment for industrial use and some other equipment, for example, stationary motors with permanent connection to fixed installation.*
- **Measurement category II** is for measurements performed on circuits directly connected to the low-voltage installation.  
*Examples are measurements on household appliances, portable tools and similar equipment.*
- **Measurement category I** is for measurements performed on circuits not directly connected to MAINS.  
*Examples are measurements on circuits not derived from MAINS, and specially protected (internal) MAINS-derived circuits. In the latter case, transient stresses are variable; for that reason, the standard requires that the transient withstand capability of the equipment is made known to the user.*

## 2. GENERAL DESCRIPTION

### 2.1. FOREWORD

This user manual is referred to the following models **MACROEVTEST**, **MACROTESTG3**, **MACROTESTG2**, **MACROTESTG1**, **COMBIG2**, **COMBITEST425**, **COMBITEST425EV**, **SUPERCOMBI**, **COMBIG2PLUS**, **MT-300** and **COMBIG3**. The model **MT-300** is the same of **MACROEVTEST**. The models **COMBITEST425EV** and **COMBIG2PLUS** are the same of **COMBIG2**. The model **COMBITEST425** is the same of **SUPERCOMBI**. Unless otherwise specified, the “instrument” is referred to **MACROEVTEST** model. The following Table 1 shows the possible functions

Symbol	Measurement description	MACRO EV TEST	MACROTEST G3	MACROTEST G2	MACROTEST G1	COMBI G2	COMBI G3	SUPER COMBI
	RPE Continuity test of earth, protective equipotential conductors and continuity test as multimeter function	✓	✓	✓	✓	✓	✓	✓
	MΩ Measurement of insulation resistance (L-PE and L/N-PE modes)	✓	✓	✓		✓	✓	✓
	RCD Test on molded case RCD (STD) and earth leakage delay tester RCDs ()	✓	✓			✓	✓	✓
	AUTO AUTO sequence of NoTrip , RCD, MΩ measures	✓	✓			✓	✓	✓
	LOOP Measurement of global earth resistance (No Trip ) and Line/Loop impedance (P-N, P-P, P-PE)	✓	✓			✓	✓	✓
	EARTH Measurement of earth resistance and soil resistivity with voltammetric methods and measurement with optional clamp	✓	✓	✓	✓			
	SEQ Detection of phase rotation with 1-wire and 2-wire method	✓	✓			✓	✓	✓
	AUX Measurement of environmental parameters (Temperature, Humidity, Illuminance of white and LED light sources)	✓	✓			✓	✓	✓
	LEAK. measurement of leakage current by using optional clamp HT96U	✓	✓			✓	✓	✓
	ΔV% Measurement of percentage voltage drop on main lines	✓	✓			✓	✓	✓
	PQA Real time measurement of main parameters (powers, harmonics, power factor/ cosφ)	✓	✓	✓	✓	✓	✓	✓
	EVSE Safety test on electric car charging system (EVSE)	✓				✓	✓	

Table 1: Characteristics of models

## 2.2. INSTRUMENT FUNCTIONS

The instrument is equipped with a TFT color LCD display, with capacitive "touch-screen" that can be handled simply with the touch of a finger by the user and is structured with an icon-based menu allowing the direct selection of measurement functions for quick and intuitive use.

The instrument can perform the following tests (compatibly with the characteristics described in Table 1):



<b>RPE</b>	Continuity test of earth, protective and equipotential conductors with test current higher than 200mA and open-circuit voltage between 4V and 24V and continuity test as multimeter function
<b>MΩ</b>	Measurement of insulation resistance L/PE or L-N/PE with continuous test voltage of 50V, 100V, 250V, 500V or 1000V DC
<b>RCD</b>	Test on molded case RCD (Standard – STD) and on earth leakage relay RCD (Ⓞ) General (G), Selective (S) and Delayed (Ⓢ) of type A (Ⓜ) and AC (Ⓝ) and B (Ⓜ) of the following parameters: tripping time, tripping current, contact voltage
<b>LOOP</b>	Measurement of line impedance/Loop P-N, P-P, P-E with calculation of the assumed short-circuit current, also with high resolution (0.1mΩ) (by means of optional accessory IMP57), overall earth resistance without causing the RCD tripping (NoTrip⚡), check of the interruption capacity of magnetothermal protections (MCB) and fuses, I2t test, protection check in case of indirect contacts
<b>AUTO TEST</b>	Automatic sequence of NoTrip⚡, RCD, MΩ (L-PE, N-PE) measurements in TT and TN systems
<b>EARTH</b>	Measurement of earth impedance and ground resistivity by voltammetric method and by an external clamp connected to the instrument (optional accessory T2100)
<b>SEQ</b>	Indication of phase sequence with 2- or 1-terminal method
<b>AUX</b>	Measurement of environmental parameters (illuminance with white light source and LED source, air temperature, humidity) by means of optional external probes and DC voltage signals
<b>LEAKAGE</b>	Measurement of leakage current (by means of the optional accessory HT96U)
<b>ΔV%</b>	Measurement of percentage voltage drop on main lines
<b>PQA</b>	Real time measurement of main parameters (powers, harmonics, power factor/cosφ) in Single phase and Three phase balanced systems
<b>EVSE</b>	Automatic sequence of safety tests on mode 2 and 3 electric car charging stations (by means of optional accessory EV-TEST100)

### 3. PREPARATION FOR USE

#### 3.1. INITIAL CHECKS

Before shipping, the instrument has been checked from an electric as well as mechanical point of view. All possible precautions have been taken so that the instrument is delivered undamaged. However, we recommend checking it to detect any damage possibly suffered during transport. In case anomalies are found, immediately contact the Dealer. We also recommend checking that the packaging contains all the components indicated in § 11.5. In case of discrepancy, please contact the Dealer. In case the instrument should be returned, please follow the instructions given in § 12.

#### 3.2. INSTRUMENT POWER SUPPLY

The instrument is powered by 6 1.5V alkaline batteries of type AA LR06 or 6 1.2V NiMH rechargeable batteries of type AA LR06. Rechargeable batteries can be recharged with the external charger. The green  symbol indicates a sufficient charge level for the correct execution of the tests. The red  symbol indicates an insufficient charge level for the correct execution of the tests. In this case, recharge the batteries (see § 10.2).

**The instrument is capable of keeping data stored even without batteries.**

The instrument has an AutoPower OFF function (which can be deactivated) after 5 minutes idling (see § 5.1.2).

#### 3.3. STORAGE

In order to guarantee precise measurement, after a long storage time under extreme environmental conditions, wait for the instrument to come back to normal condition (see § 11.4.1).

## 4. NOMENCLATURE

### 4.1. INSTRUMENT DESCRIPTION

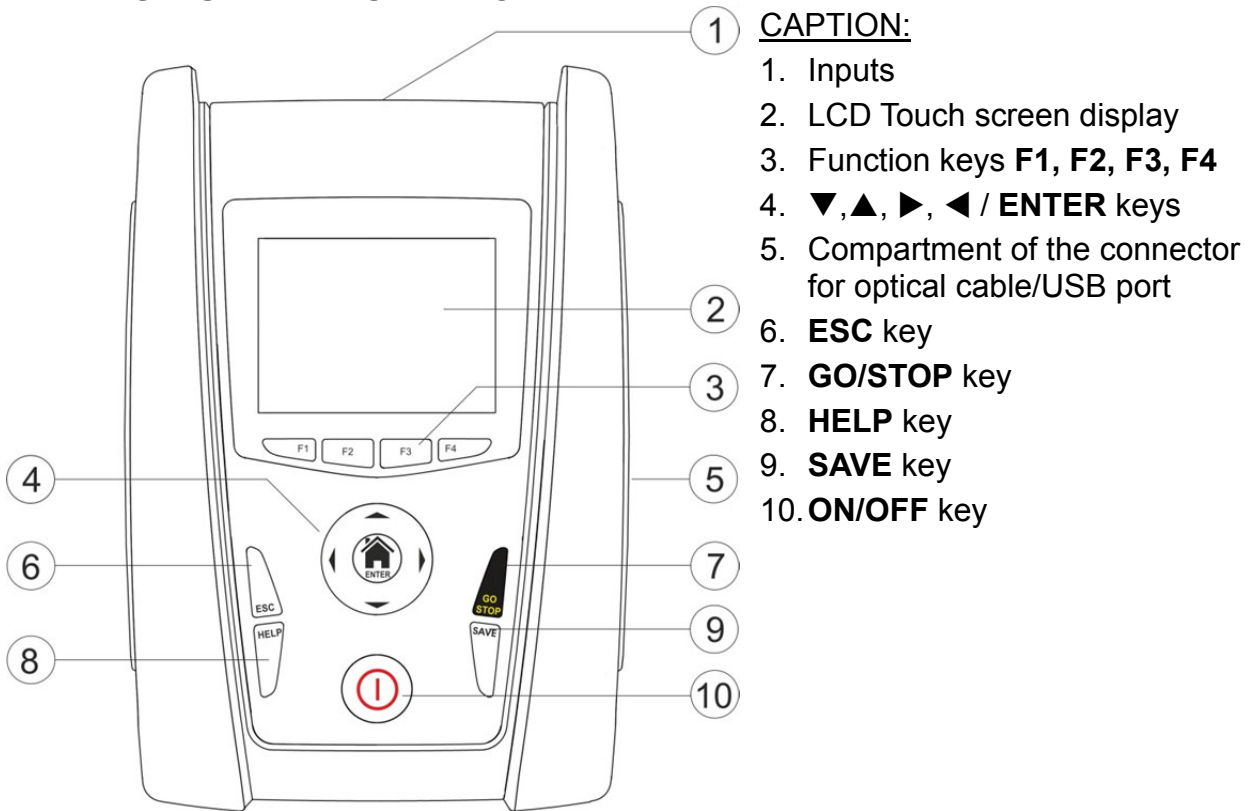

Fig. 1: Description of the front part of the instrument

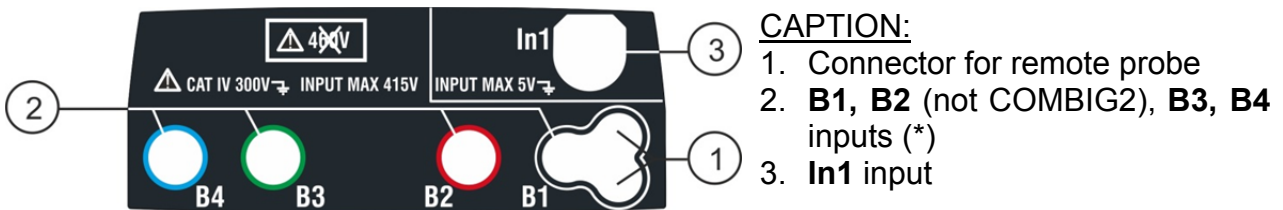

Fig. 2: Description of the upper part of the instrument

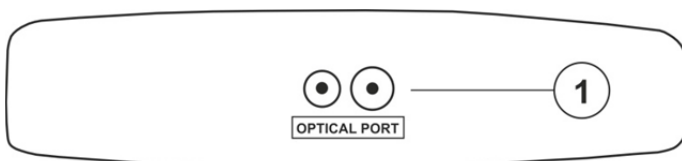

Fig. 3: Description of the instrument's side

### 4.2. DESCRIPTION OF MEASURING LEADS

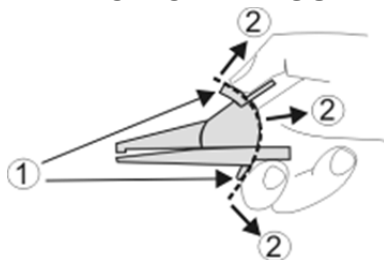

Fig. 4: Description of measuring leads

(\*) The colors of input terminals and test cables can be change depending on the different Countries

### 4.3. KEYBOARD DESCRIPTION

The keyboard includes the following keys:



**ON/OFF** key to switch on/off the instrument



**ESC** key to exit the selected menu without confirming



◀ ▶ ▲ ▼ keys to move the cursor through the different screens in order to select the desired programming parameters

**HOME** / **ENTER** key to back to general Menu on each moment



**GO/STOP** key to start the measurement



**SAVE** key to save the measured values



**HELP** key to access the online help and display the possible connections between the instrument and the system for each selected function

**F1, F2, F3, F4** Function keys corresponding to the activation of the four icons on the bottom of the screen as an alternative to direct touch on the display

### 4.4. DISPLAY DESCRIPTION

The display is an LCD, 320x240pxl TFT color display with capacitive touch screen whose icon-structure can be directly selected with a simple touch. The first line of the display indicates the type of active measurement, the date/time and the battery charge indication.



### 4.5. INITIAL SCREEN

When switching on the instrument, the initial screen appears for a few seconds. It shows:

- The HT manufacturer's logo
- The instrument model
- The Firmware version of the two instrument's internal microprocessors (LCD and CPU)
- The serial number (SN:) of the instrument
- The date of instrument calibration (Calibration date:)



After a few seconds, the instrument switches to the general menu.



## 5. GENERAL MENU

Pressing the **ENTER** key in any condition of the instrument allows to go back to the general menu in which internal parameters may be set, the saved measures can be displayed and the desired measuring function may be selected.

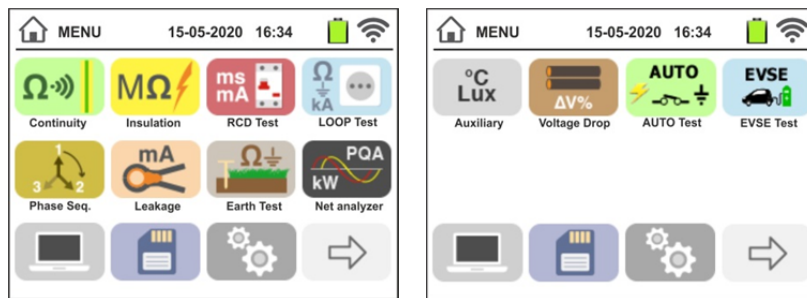





Fig. 5: General menu of the instrument

Touch the icon  to move to the following page of the general menu. Inside the screens, touch the icon  to confirm a selection or the icon  to exit without confirming.

### 5.1. INSTRUMENT SETTINGS

Touch the  icon. The screen to the side appears on the display. The following settings are available:

- System language setting
- Setting of the type of electrical system
- Setting of the country
- Operator name setting
- System date/time setting
- Information instrument section
- Activation/deactivation of display AutoPower OFF and of key sound

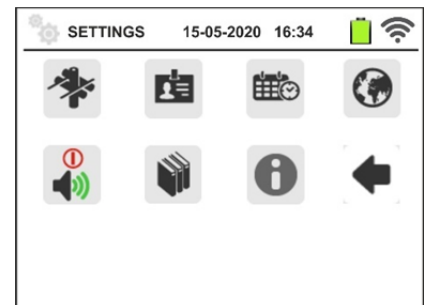

Settings will be maintained also after switching off the instrument.

#### 5.1.1. Language

Touch the icon  to select the system language. The screen to the side appears on the display.

Select the desired language, confirm the choice and return to the previous screen.

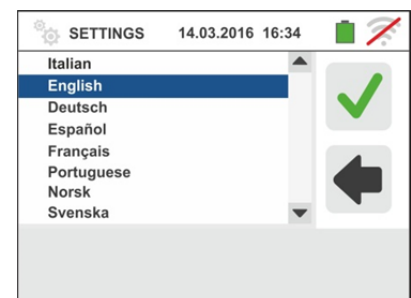

### 5.1.2. Reference country



Touch the icon  to select the reference country. This choice have influence on the LOOP, NoTrip $\frac{+}{-}$  and EARTH measurements. The screen to the side appears on the display. Select the desired country, confirm the choice and return to the previous screen.

**NOTE:** in the EUR, UK no USA, GER, AUS/NZ and NOR countries the guide user interface and the result of the LOOP $\frac{+}{-}$  and NoTrip $\frac{+}{-}$  tests can be modified

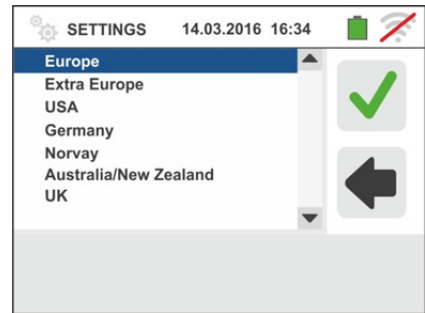

### 5.1.3. Automatic Power OFF for display and key sound



Touch the  icon. The screen to the side appears on the display.

Move the slide bar reference of section "ⓘ" down/up to turn off/on the Automatic Power OFF of the instrument after a period of inactivity of 5 minutes.



Move the slide bar reference of section "👆" down/up to disable/enable the sound key when pressed. Confirm the choices made and go back to the previous screen.

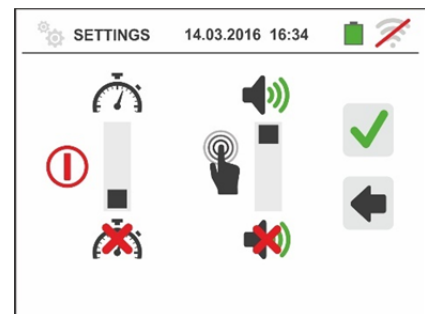

### 5.1.4. System



Touch the icon  to select the type of electrical system (TT, TN or IT), of the mains frequency (50Hz, 60Hz), of the limit value for contact voltage (25V, 50V) and rated voltage value to be used for calculating the assumed short-circuit current (see §). The screen to the side appears on the display. **NOTE: for "USA" country this icon is not displayed and the electrical system is fixed to TN**

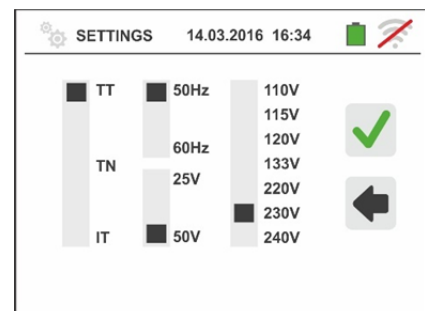

Move the slide bar references to select the options. Confirm the choices made and go back to the previous screen.

### 5.1.5. Operator name entry



Touch the icon  to enter the name of the operator that will be displayed in the header of each measurement downloaded to PC. The screen to the side appears on the display.

- Set the desired name using the virtual keyboard (max 12 characters).
- Confirm the settings or exit without saving.

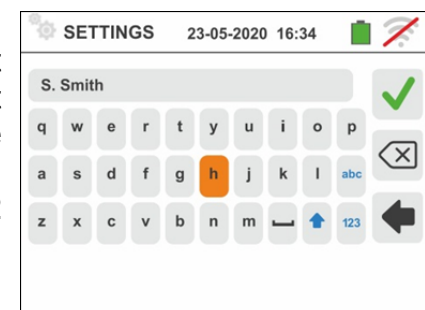

### 5.1.6. System date/time setting

Touch the icon to set the system date/time. The screen to the side appears on the display.

Touch the "EU" icon for the European date/time system in the format "DD/MM/YY hh:mm" or the "US" icon for the American system in the format "MM/DD/YY hh:mm AM/PM". Touch the up/down arrow keys to set the desired value. Confirm the settings or exit without saving.

**Current date/time is kept inside the instrument without batteries for approximately 12 hours.**

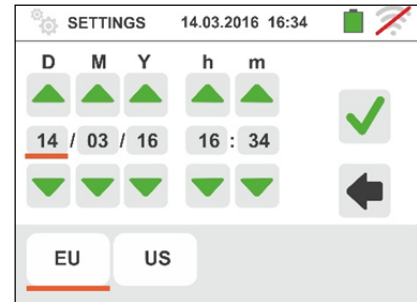

### 5.1.7. Information

Touch the icon . The display shows the screen on the right with the icons relative to the properties of the instrument, the optional accessories IMP57 and T2100 and the HTAnalysis APP

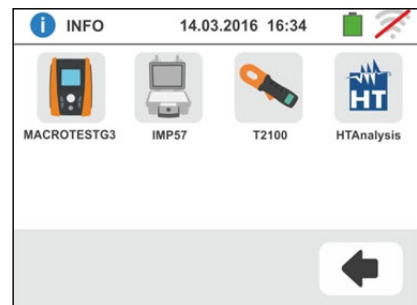

Touch the icon . The display shows the screen on the right as well as following information:

- Serial number
- Internal version of Firmware and Hardware (for the accessories IMP57 and T2100 these informations are available only after the connection to the instrument)
- Last calibration date



Touch the icon . The display shows the screen on the right with the QR code of HTAnalysis APP (see § 8.1).

Touche the icon to exit and return to the general menu



## 6. OPERATING INSTRUCTIONS

### 6.1. RPE: CONTINUITY OF PROTECTIVE CONDUCTORS

This function is performed in compliance with standards IEC/EN61557-4, BS7671 17th edition, AS/NZS 3000, AS/NZS 3017 and allows measuring the resistance of protective and equipotential conductors.



#### CAUTION

- The instrument can be used for measurements on installations with overvoltage category CAT IV 300V to earth and max 415V between inputs
- We recommend holding the alligator clip respecting the safety area created by the hand protection (see § 4.2).
- Check that no voltage is present at the ends of the item to be tested before carrying out a continuity test.
- The results may be influenced by the presence of auxiliary circuits connected in parallel with the item to be tested or by transient currents.

The following operating modes are available:



Compensation of the resistance of the cables used for measurement. The instrument automatically subtracts the value of cable resistance from the measured resistance value. Therefore, it is necessary that this value is measured each time the measuring cables are changed or extended.

**AUTO**

The instrument carries out two measurements with inverted polarity and displays their average value. Recommended mode



The instrument performs a continuity test between two points like a common multimeter without the possibility to save the test result



The instrument carries out the measurement with the possibility of setting a duration time for testing. The operator may set a sufficiently long measuring time (between **1s** and **15s**) to be able to move the protective conductors while the instrument is carrying out the test, in order to find out a possible bad connection.



#### CAUTION

Continuity test is carried out by supplying a current higher than 200mA in case the resistance does not exceed ca. 2Ω (including resistance of the test cables). For higher resistance values, the instrument carries out the test with a current lower than 200mA.

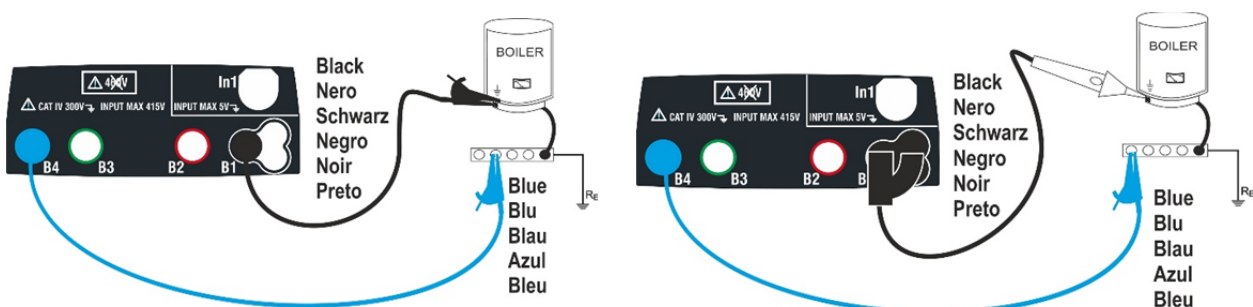

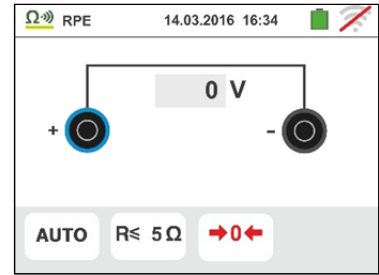
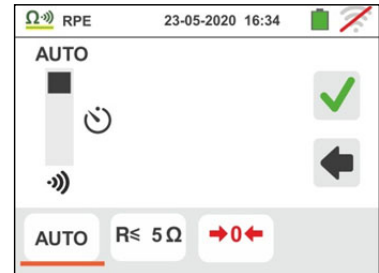



Fig. 6: Continuity test by means of single cables and remote lead

1. Touch the  icon. The screen to the side appears on the display. The instrument automatically carries out the test for the presence of voltage between the inputs (shown on the display) and blocks the test in case of voltage higher than 10V. Touch the "AUTO" icon to set the measuring mode. The following screen appears on the display:



2. Move the slide bar reference in the positions "AUTO" (Automatic mode), "⌚" (Timer mode) or "📡" (Multimeter mode). Confirm the choice by going back to the previous screen. If Timer mode is selected, the following screen is shown:



3. Touch the  icon to zero the value in the Timer field and use the virtual keyboard to set the value in seconds between **1s** and **15s**. Confirm the choice by going back to the initial measurement screen.

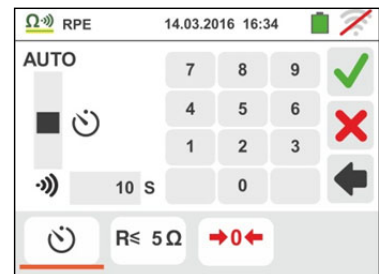

4. Touch the icon " $R \leq xx\Omega$ " to set the maximum limit value of the resistance on which the instrument makes the comparison with the measured value. The screen to the side appears on the display.

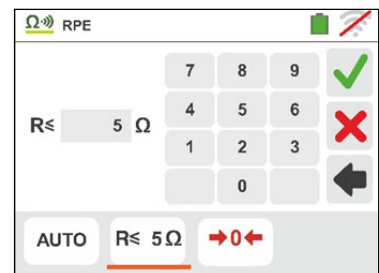

Touch the  icon to zero the value in the " $R \leq$ " field. Use the virtual keyboard to set the value between **0.01Ω** and **9.99Ω**. Confirm the choice by going back to the initial measurement screen. Note the presence of the set limit value.

5. Perform, if necessary, the compensation of the measuring leads resistance by connecting the cables or the remote lead as shown in Fig. 7.

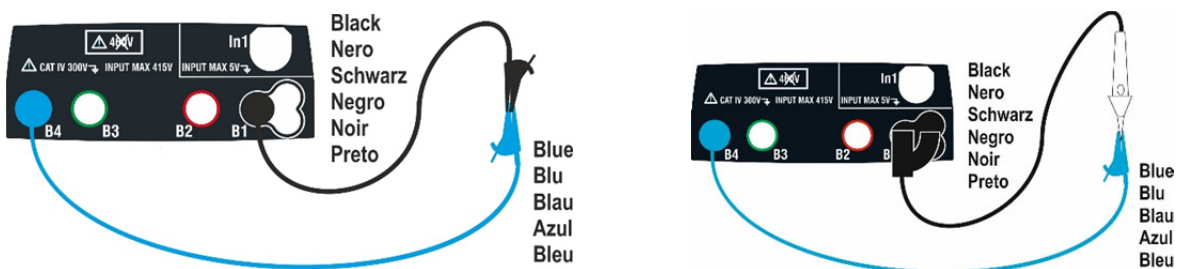
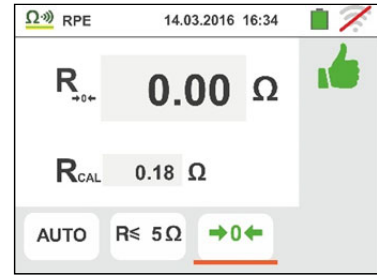

Fig. 7: Compensation of single cables and remote lead resistance

6. Touch the icon to activate the measurement. After a few seconds, the instrument provides the screen to the side if the operation is successful ( $R_{cables} \leq 5\Omega$ ); the indication of the value is shown in the "Rcal" field and the icon is shown on the display.



Touch the "AUTO" icon or "" to go back to the main measurement screen.

### CAUTION



Before connecting the test leads, make sure that there is no voltage at the ends of the conductor to be tested.

7. Connect the alligator clips and/or test leads and/or remote lead to the conductor to be tested as in Fig. 6.

### CAUTION



Always make sure, before any measurement, that the compensation resistance value is referred to the cables currently used. In case of doubt, repeat points 5 and 6.

8. Press the **GO/STOP** key on the instrument or the **START** key on the remote lead. The instrument will start the measurement. During this whole stage, do not disconnect the test leads of the instrument from the conductor under test. The following screen appears on the display:

9. The value of the result in the AUTO function is shown in the upper part of the screen, while the partial values of the test with inverted polarity of the test source in addition to the real test currents are reported in the fields "R+" and "R-".

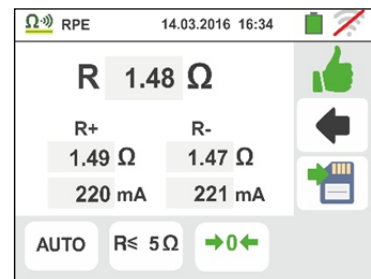

The symbol indicates the positive result of the measurement.

Press the **SAVE** button or touch the icon to save the measurement (see § 7.1)

10. The value of the result in the "" function is shown in the screen to the side. The instrument emits a continuous sound if the measured value is less than or equal to the set threshold. Press the **GO/STOP** button on the instrument again or the **START** button on the remote probe to stop the measurement.

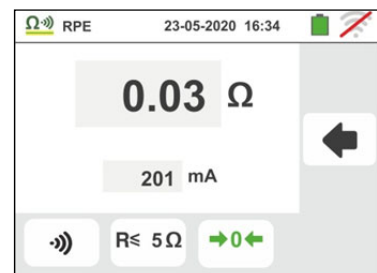

This function does not allow to save the result in memory



11. At the end of the test **in the AUTO function** if the value of the measured resistance is higher than the set limit, the screen to the side is shown on the display.

The value is shown in red and the  symbol indicates the negative result of the measurement. The "> 99.9Ω" message indicates the instrument overload status.

Press the **SAVE** button or touch the  icon to save the measurement (see § 7.1).

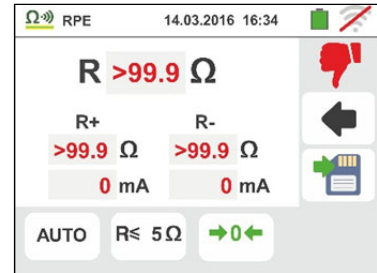

12. At the end of the test in the “” function if the value of the measured resistance is higher than the set limit, the value is shown in red. The indication ">1999Ω" indicates the overrange of the instrument as shown in the screen to the side



### 6.1.1. Anomalous situations

1. In AUTO or "🕒" modes if the instrument detects a resistance lower than the set limit value but for which it is not able to generate a current of 200mA, the screen to the side is displayed.

The 👍 symbol is shown on the display and the values of the real test current are indicated in red.

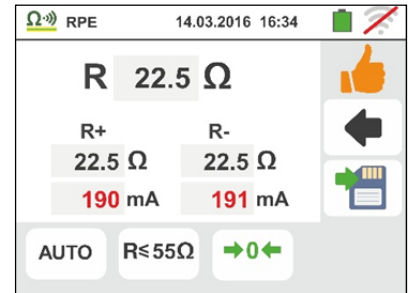

2. If in →0← mode the instrument detects a resistance higher than 5Ω at its terminals, it resets the offset value and displays a screen like the one to the side. The →0← icon is shown on the display to indicate the calibration reset value (i.e. performing the operation with open terminals).



3. In case the instrument detects a calibration reset (performing the operation with open terminals), it gives out a long sound and displays a screen like the one to the side. The →0← icon is shown on the display to indicate the calibration reset value.



4. If the instrument detects a calibrated resistance higher than measured resistance (e.g. by using test cables different from the supplied ones) at its terminals, it gives out a long sound and displays a screen like the one to the side. Perform a calibration reset with open terminals and start a new calibration.

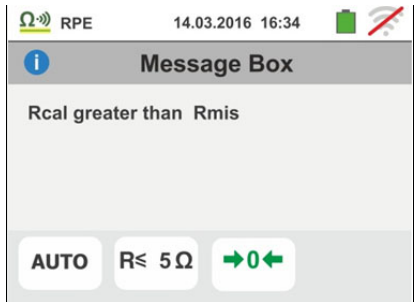

5. If the instrument detects a voltage value higher than 10V at its terminals, it does not carry out the test, gives out a long sound and the screen reported here to the side is displayed.

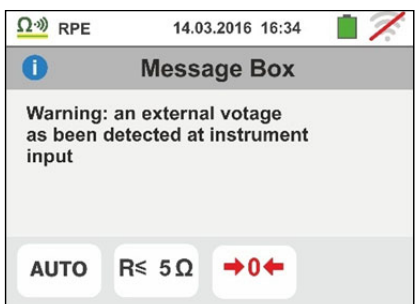

## 6.2. MΩ: MEASUREMENT OF INSULATION RESISTANCE

This function is performed in compliance with standards IEC/EN61557-2, BS7671 17th edition, AS/NZS 3000, AS/NZS 3017 and allows measuring the insulation resistance between the active conductors and between each active conductor and the earth.



### CAUTION

- The instrument can be used for measurements on installations with overvoltage category CAT IV 300V to earth and max 415V between inputs.
- We recommend holding the alligator clip respecting the safety area created by the hand protection (see § 4.2).
- Check that the circuit being tested is not live and that all possible loads normally connected to it are disconnected before carrying out insulation measurement.

The following operating modes are available:

**AUTO L-PE** The test is performed between L-PE conductors and activated by the **GO/STOP** key of the instrument (or **START** of the remote lead) and lasts 2 seconds

**AUTO L/N-PE** The test is performed between L-PE and N-PE conductors and activated by the **GO/STOP** key of the instrument (or **START** of the remote lead) and lasts 2 seconds. Recommended mode



**Timing test between L-PE conductors** The operator may set a sufficiently long measuring time (**5s ÷ 999s**) to be able to move the test lead on the conductors being tested, while the instrument is carrying out the test. For the whole measurement duration, the instrument will give out a short sound every second. While measuring, if the insulation resistance reaches a lower value than the set limit, the instrument will give a continuous acoustic signal. To stop the test, press again the **GO/STOP** key on the instrument or the **START** key on the remote lead.

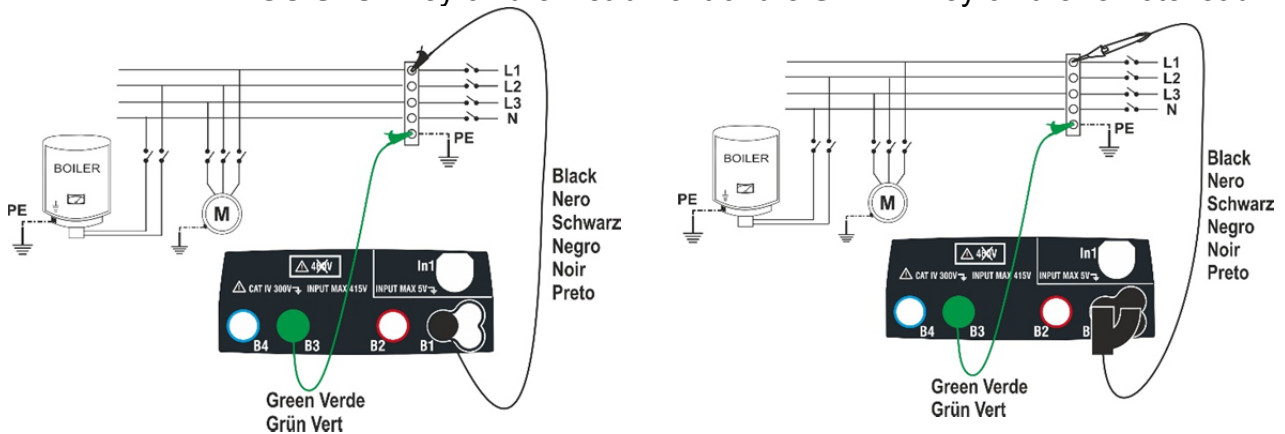

Fig. 8: Insulation test between L-PE by means of single cables and remote lead

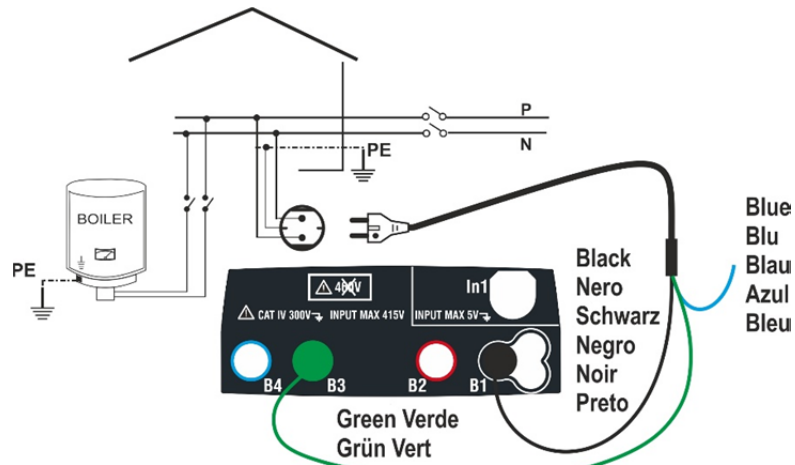

Fig. 9: Insulation test between L-PE by means of shuko plug

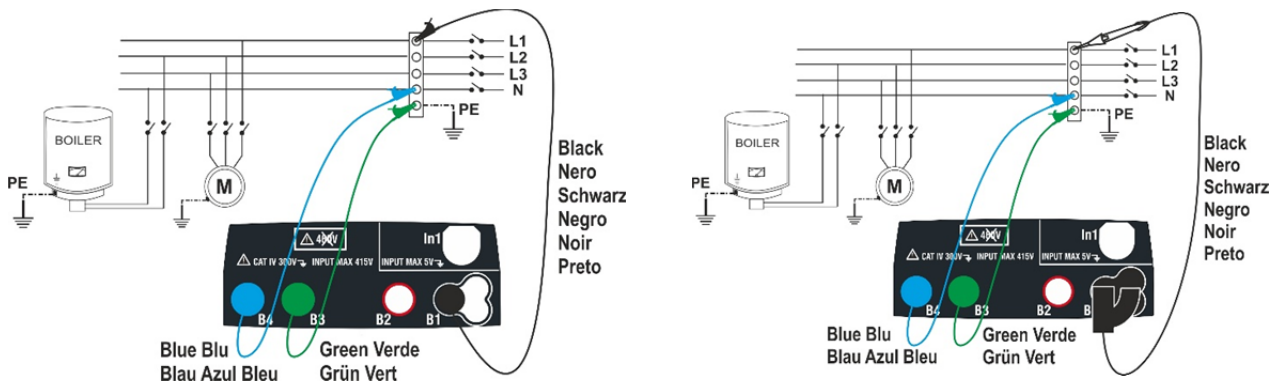

Fig. 10: Insulation test between L-PE and N-PE by means of single cables and remote lead

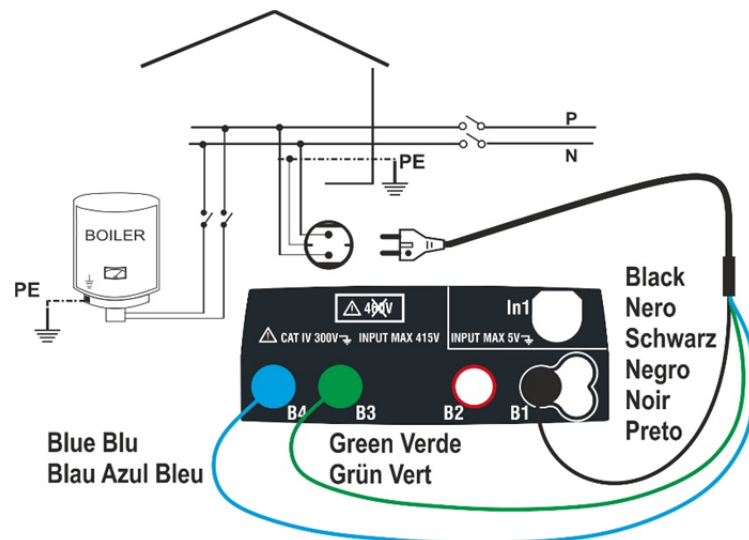

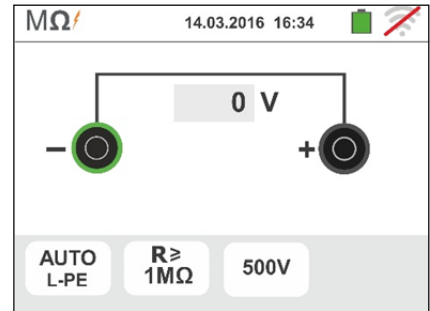

Fig. 11: Insulation test between L-PE and N-PE by means of shuko plug

### 6.2.1. AUTO or L-PE Timer mode

1.

Touch the  icon. The screen to the side appears on the display. The instrument automatically carries out the test for the presence of voltage between the inputs (shown on the display) and blocks the test in case of voltage higher than 10V  
 Touch the "AUTO L-PE" icon to set the measuring mode. The following screen appears on the display:



2. Move the slide bar reference in the positions "AUTO" (Automatic mode) or "⌚" (Timer mode). Move the right slide bar reference in the "L-PE" position. Confirm the choice by going back to the previous screen.

If Timer mode is selected, the following screen is shown:

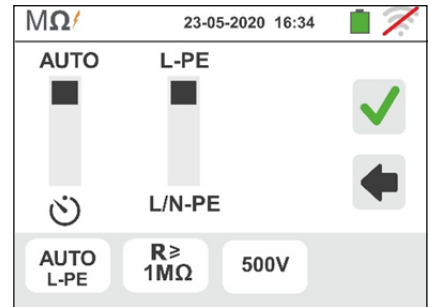

3.

Touch the  icon to zero the value in the Timer field and use the virtual keyboard to set the value in seconds between **5s** and **999s**. Confirm the choice by going back to the initial measurement screen.

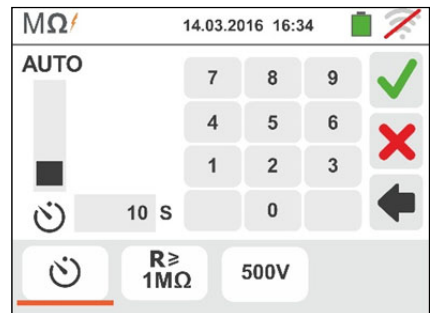

4. Touch the icon "R≥xxΩ" to set the minimum limit value of the insulation resistance on which the instrument makes the comparison with the measured value. The screen to the side appears on the display.

Touch the  icon to zero the value in the "R≥" field. Use the virtual keyboard to set the value between **0.01MΩ** and **999MΩ**. Confirm the choice by going back to the initial measurement screen. Note the presence of the set limit value.



5. Touch the "xxxxV" icon to set the test DC voltage in the insulation measurement. The screen to the side appears on the display.

Move the slide bar reference to the desired value for test voltage by choosing among **50, 100, 250, 500, 1000VDC**.

Confirm the choice by going back to the initial measurement screen. Note the presence of the set limit value.

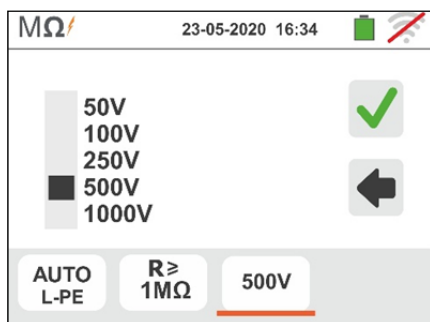

### CAUTION



- Disconnect any cable not strictly involved in measurement and especially check that no cable is connected to In1 input.
- Before connecting the test leads, make sure that there is no voltage at the ends of the conductors to be tested.

6. Connect the alligator clips and/or test leads and/or remote lead to the ends of the conductors to be tested as in Fig. 8 and Fig. 9.
7. Press the **GO/STOP** key on the instrument or the **START** key on the remote lead. The instrument will start the measurement.

### CAUTION



During this whole stage, do not disconnect the test leads of the instrument from the conductor under test. It could remain charged with a dangerous voltage due to the stray capacitances in the circuit being tested.

8. Regardless of the operating mode selected, at the end of the measurement, the instrument applies a resistance to the output leads to discharge the capacitances in the circuit.
9. **In mode:**
  - The final result is the minimum insulation value measured during the test
  - Pressing a second time the **GO/STOP** key or the **START** key on the remote lead stops the test before the set time has elapsed.

10. The measurement result is shown both as a numeric value and in the analog bar graph as shown in the screen to the side. The values of the real test voltage and the measurement time are present on the display.

The symbol indicates the positive result of the measurement.

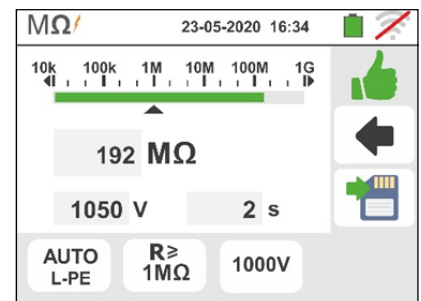

Press the **SAVE** button or touch the icon to save the measurement (see § 7.1).

11. At the end of the test, if the value of the measured resistance is lower than the set limit, the screen to the side is shown on the display.

The value is shown in red and the symbol indicates the negative result of the measurement.

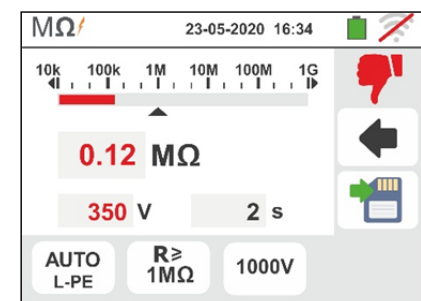

Press the **SAVE** button or touch the icon to save the measurement (see § 7.1).



### 6.2.2. AUTO L/N-PE mode

1.



Touch the icon. The screen to the side appears on the display. The instrument automatically carries out the test for the presence of voltage between the inputs (shown on the display) and blocks the test in case of voltage higher than 10V

Touch the "AUTO L/N-PE" icon to set the measuring mode. The following screen appears on the display:

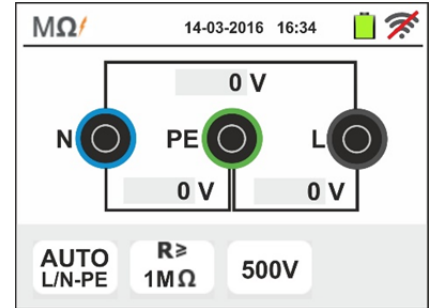

2. Move the slide bar reference in the positions "AUTO" (Automatic mode) or "⌚" (Timer mode). Move the right slide bar reference in the "L/N-PE" position. Confirm the choice by going back to the previous screen.

If Timer mode is selected, the following screen is shown:

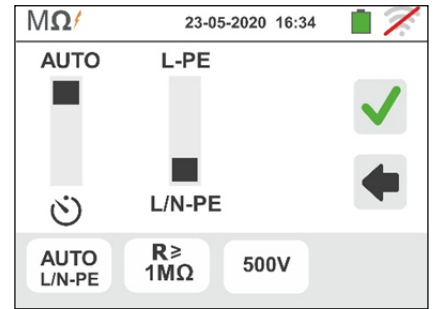

3. Touch the icon "R>xxΩ" to set the minimum limit value of the insulation resistance on which the instrument makes the comparison with the measured value. The screen to the side appears on the display.



Touch the icon to zero the value in the "R>" field. Use the virtual keyboard to set the value between **0.01MΩ** and **999MΩ**. Confirm the choice by going back to the initial measurement screen. Note the presence of the set limit value.



4. Touch the "xxxxV" icon to set the test DC voltage in the insulation measurement. The screen to the side appears on the display.

Move the slide bar reference to the desired value for test voltage by choosing among **50, 100, 250, 500, 1000VDC**

Confirm the choice by going back to the initial measurement screen. Note the presence of the set limit value.

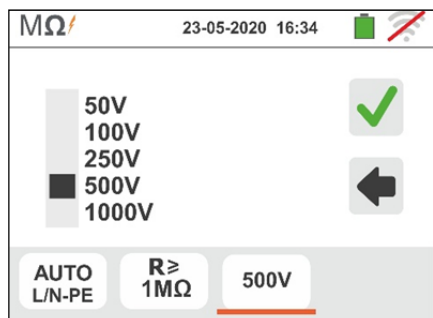

### CAUTION

- Disconnect any cable not strictly involved in measurement and especially check that no cable is connected to In1 input.
- Before connecting the test leads, make sure that there is no voltage at the ends of the conductors to be tested.

5. Connect the alligator clips and/or test leads and/or remote lead to the ends of the conductors to be tested as in Fig. 10 and Fig. 11

6. Press the **GO/STOP** key on the instrument or the **START** key on the remote lead. The instrument will start the insulation measurement in sequence before between L-PE and then between N-PE

### CAUTION



During this whole stage, do not disconnect the test leads of the instrument from the conductor under test. It could remain charged with a dangerous voltage due to the stray capacitances in the circuit being tested.

7. Regardless of the operating mode selected, at the end of the measurement, the instrument applies a resistance to the output leads to discharge the capacitances in the circuit.

8. The measurement result is shown in the screen to the side. The values of the real test voltage and the measurement time are present on the display.

The  symbol indicates the positive result of the measurement.

Press the **SAVE** button or touch the  icon to save the measurement (see § 7.1)



9. At the end of the test, if the value of the measured resistance in one or both test should be lower than the set limit, the screen to the side is shown on the display.

The value is shown in red and the  symbol indicates the negative result of the measurement.

Press the **SAVE** button or touch the  icon to save the measurement (see § 7.1)



### 6.2.3. Anomalous situations

6. **In the L-PE test** if the instrument measures a resistance higher than the set limit value but for which it is not able to generate the rated voltage, the screen to the side is displayed.

The symbol is shown on the display and the values of the real test voltage are indicated in red.

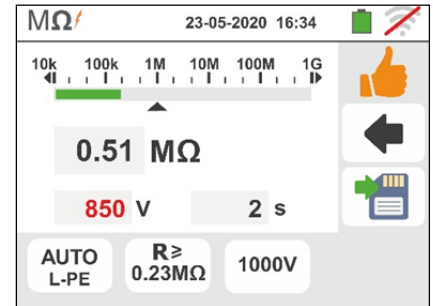

7. **In the L/N-PE test** if in one of both test the instrument measures a resistance higher than the set limit value but for which it is not able to generate the rated voltage, the screen to the side is displayed.





The symbol is shown on the display and the values of the real test voltage are indicated in red



8. If the instrument detects a voltage value higher than 30V at its terminals, it does not carry out the test, gives out a long sound and the screen reported here to the side is displayed.



### 6.3. RCD: TEST ON DIFFERENTIAL SWITCHES

This function is performed in compliance with standard IEC/EN61557-6, BS7671 17th edition, AS/NZS 3000, AS/NZS 3017 and allows measuring the tripping time and current of molded case differential switches of type A () AC () and B () being General (G), Selective (S) and Delayed (). The instrument allows performing tests on earth leakage relay RCDs with currents up to 10A (with optional accessory RCDX10)



#### CAUTION

Some combinations of test parameters can be not available in compliance with the technical specification of the instrument and the RCD tables (see § 11.1 – the empty cells of RCD tables means not available situations)

The following operating connections are available to perform the RCD test:



#### CAUTION

Testing the RCD tripping time causes its tripping. **Therefore, check that there are NO users or loads connected downstream of the differential switch being tested which could be damaged by a system downtime.** Disconnect all loads connected downstream of the differential switch as they could produce leakage currents further to those produced by the instrument, thus invalidating the results of the test.

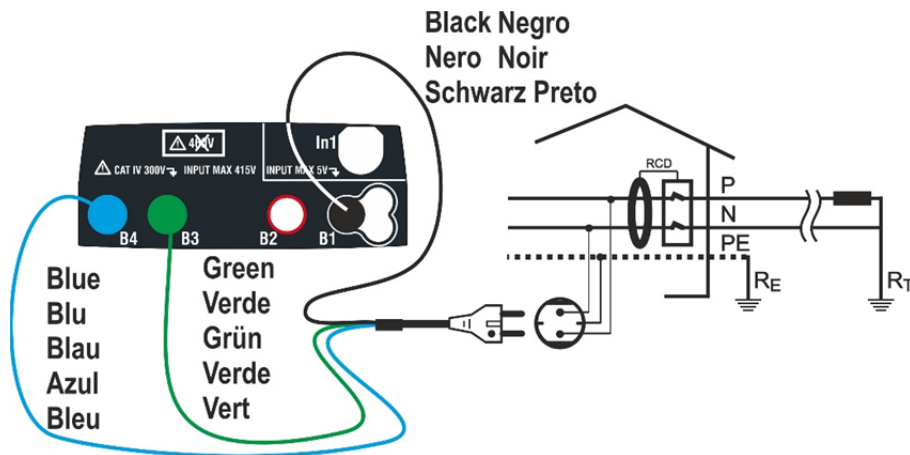

Fig. 12: Connection for single-phase 230V system by means of shuko plug

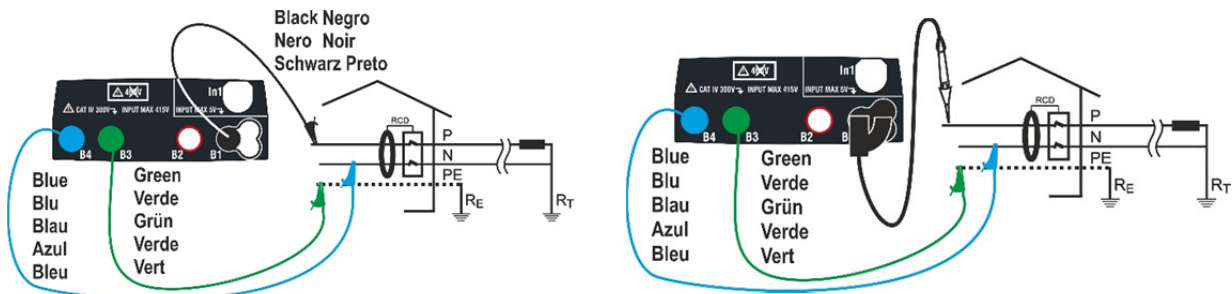

Fig. 13: Connection for single-phase 230V system with single cables and remote lead

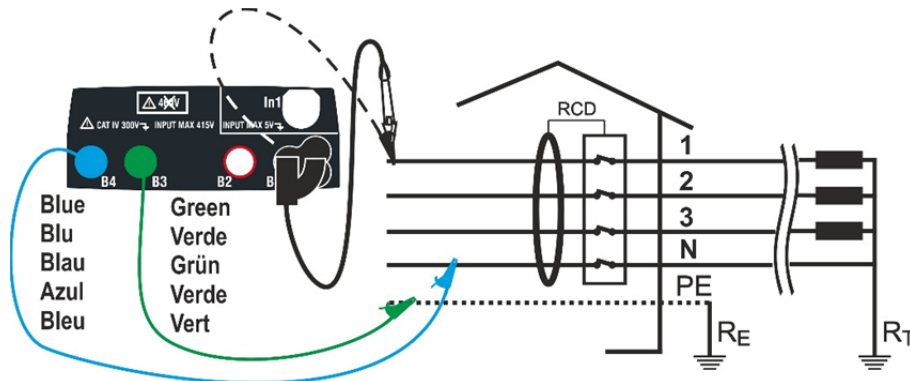

Fig. 14: Connection for a 400V + N + PE three-phase system by means of single cables and remote lead

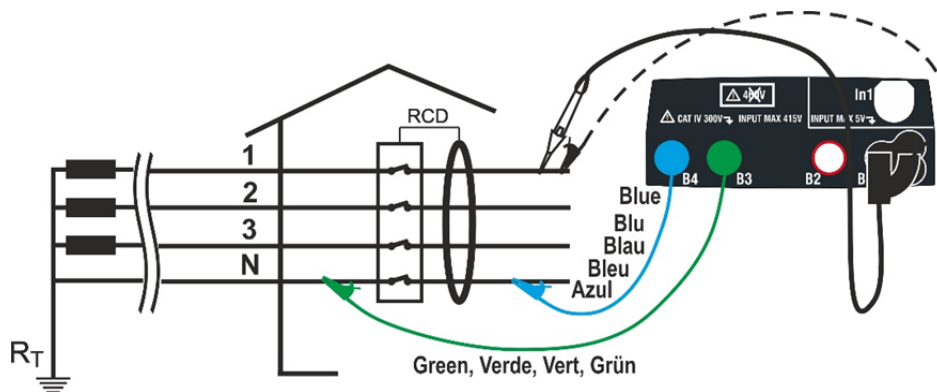

Fig. 15: Connection for a 400V + N (no PE) three-phase system by means of single cables and remote lead

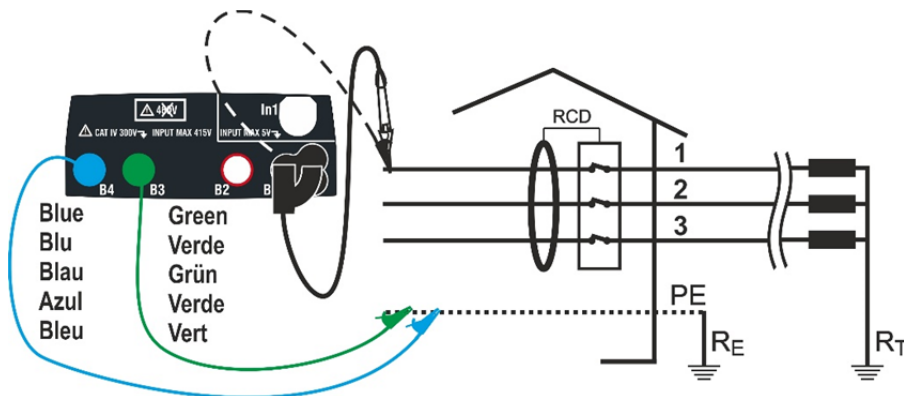

Fig. 16: Connection for a 400V + PE (no N) system with single cables and remote lead  
[no for RCD type B]

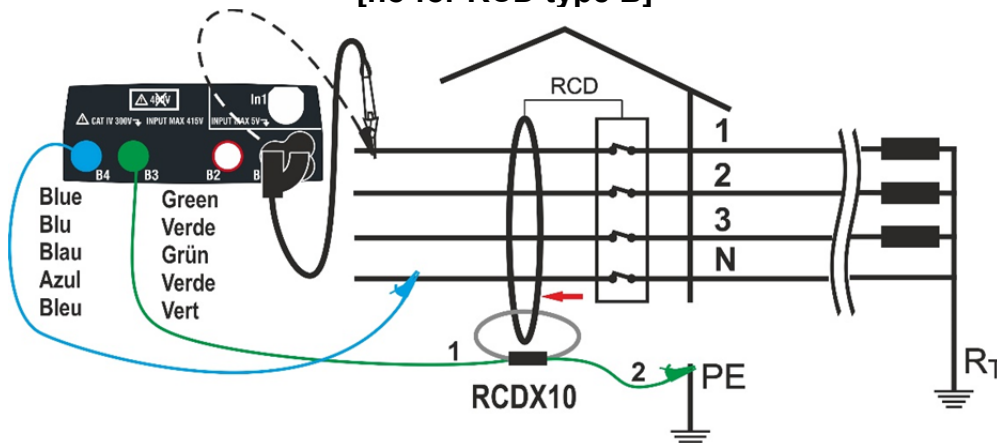

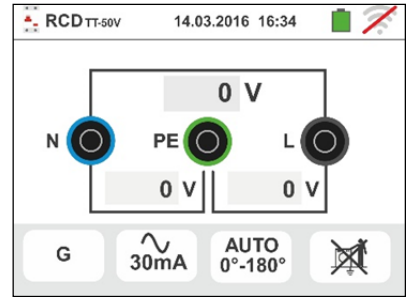

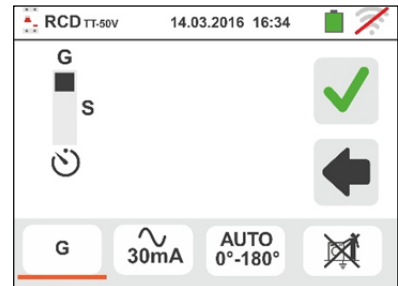



Fig. 17: Connection to earth leakage relay RCDs with optional accessory RCDX10

1. Touch the  icon. The screen to the side appears on the display. Touch the icon to the left to set the RCD operating mode. The following screen appears on the display:



2. Move the slide bar reference by selecting the desired operating mode between the options: **G** (General), **S** (Selective),  (Delayed). Confirm the choice by going back to the initial measurement screen. Note the presence of the chosen selection. When selecting a Delayed RCD, the instrument displays the following screen.





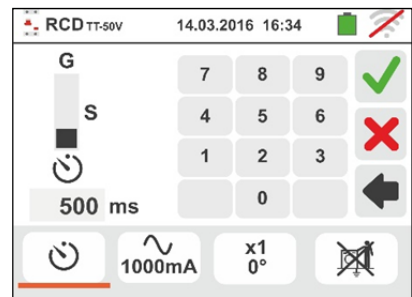

3. Touch the  icon to zero the value in the Timer field and use the virtual keyboard to set the value of RCD delay time in seconds between **1ms** and **500ms**. Confirm the choice by going back to the initial measurement screen. Touch the second icon to set the type of RCD, the waveform and the tripping current. The following screen appears on the display.

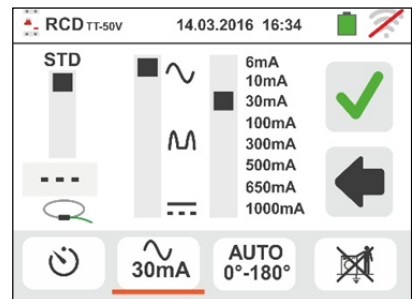

4. Move the left slide bar reference and select the type of RCD between the following options: **STD** (molded case RCD) and  (earth leakage delay RCD with use of optional accessory RCDX10). In case of earth leakage relay RCD the following screen appears on the display



5. Touch the icon  to zero the value in “A” field and use the virtual keyboard to set the value of rated current of earth leakage relay RCD. The maximum rated current is **10.0A**. Confirm the choice by going back to the previous screen. Move the second slide bar reference by selecting the waveform of the differential switch between the options:  (type AC),  (type A),  (type B). For RCD of **molded case type STD** move the third slide bar reference by selecting the desired rated current of the differential switch between the options: **6,10, 30, 100, 300, 500, 650, 1000mA**. Confirm the choice by going back to the initial measurement screen. Note the presence of the chosen selections

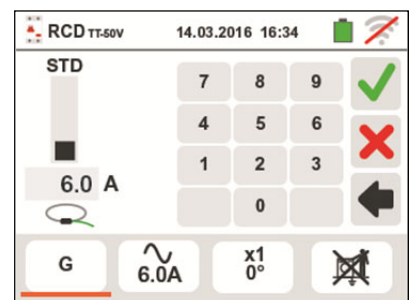



6. Touch the third icon at the bottom of display and select the desired type of test among the options::
- **x 1/2** → Manual with multiplier 1/2 I<sub>dn</sub>
  - **x 1** → Manual with multiplier 1I<sub>dn</sub>
  - **x 2** → Manual with multiplier 2I<sub>dn</sub>
  - **x 5** → Manual with multiplier 5I<sub>dn</sub>
  - **AUTO** → Auto mode (6 tests in sequence)
  - → Ramp (real tripping current measurement)
  - **AUTO+** → Automatic tripping time + tripping current mode (8 tests in sequence)

Move the right slide bar reference by selecting the polarity of the test current between the options: **0°** (direct polarity), **180°** (inverted polarity), **0°-180°** (for Automatic mode only). Move the lower right slide bar reference by selecting (for Ramp mode only) the kind of the trip out current visualization between the followed options:

- **NOM** → the instrument shows the normalized value of trip out current (referred to the nominal current). **Example:** for RCD type A with I<sub>dn</sub>=**30mA** the effective value of normalized trip out current can be up to **30mA**
- **REAL** → the instrument shows the effective value of the trip out current by considering the coefficients indicated by the IEC/EN61008 and IEC/EN61009 guidelines (1.414 for RCD type A, 1 for RCD type AC, 2 for RCD type B). **Example:** for RCD type A with I<sub>dn</sub>=**30mA** the effective value of trip out current can be up to **30mA \* 1.414 = 42mA**

**NOTE: The selection of the two option involves only the choose of the trip out current visualization but not influence the outcome test (OK/NO).** Confirm the choice by going back to the initial measurement screen

7. Touch the fourth icon at the bottom of the display and select the possible visualization of the contact voltage value at the end of measurement. The following options are possible:

- → The value of contact voltage is shown on the display at the end of measurement
- → The value of contact voltage is not shown on the display at the end of measurement

8. Insert the green, blue and black connectors of the three-pin shuko plug into the relevant instrument input terminals B3, B4, B1. As an alternative, use the single cables and apply the relevant alligator clips to the free ends of the cables. It is also possible to use the remote lead by inserting its multipolar connector into the input lead B1. Connect the shuko plug, the alligator clips or the remote lead to the electrical mains according to Fig. 12, Fig. 13, Fig. 14, Fig. 15 and Fig. 16.

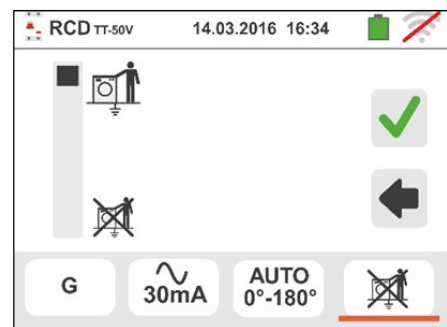
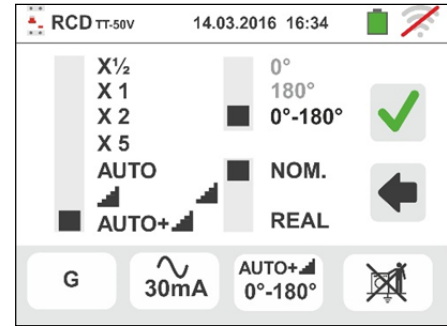



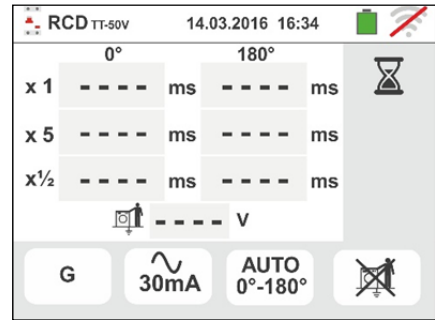

6.3.1. **AUTO mode**

9. Press the **GO/STOP** key for few seconds on the instrument or the **START** key on the remote lead. The instrument will start the measurement.

The screen to the side is shown on the display when the hourglass icon indicates the performance of the test.



10 The AUTO mode foresees the automatic execution of 6 measurements in a sequence:

- IdN x 1 with phase 0° (the RCD must trip, reset the switch, icon )
- IdN x 1 with phase 180° (the RCD must trip, reset the switch, icon )
- IdN x 5 with phase 0° (the RCD must trip, reset the switch, icon )
- IdN x 5 with phase 180° (the RCD must trip, reset the switch, icon )
- IdN x 1/2 with phase 0° (RCD must not trip)
- IdN x 1/2 with phase 180° (RCD must not trip, end of test)

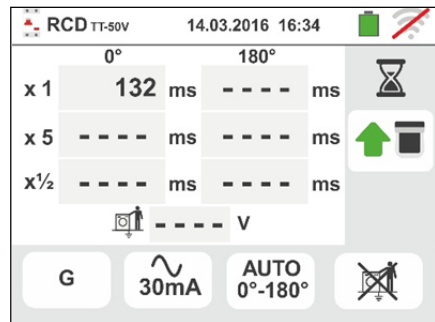

11 The test has a positive result if all tripping times of **molded case type STD** comply with what indicated in Table 6 (see § 13.4). The test has a negative result when one of the values is out of range. During this whole stage, do not disconnect the measuring leads of the instrument from the system on test.

12 At the end of the test, if the tripping time of each test complies with what is indicated in Table 6 (see § 13.4)

the instrument shows the  symbol to signal that the test has been completed successfully, and displays a screen similar to the one reported here to the side.

Press the **SAVE** button or touch the  icon to save the measurement (see § 7.1).

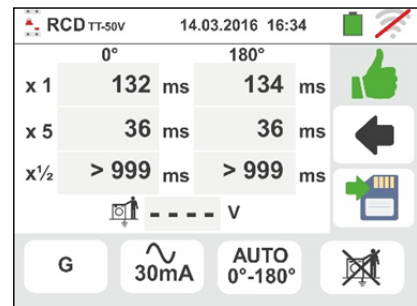

13 At the end of the test, if the tripping time of a test does not comply with what is indicated in Table 6 (see §

13.4). the instrument shows the  symbol to signal that the test has not been completed successfully, and displays a screen similar to the one reported here to the side.

Press the **SAVE** button or touch the  icon to save the measurement (see § 7.1).

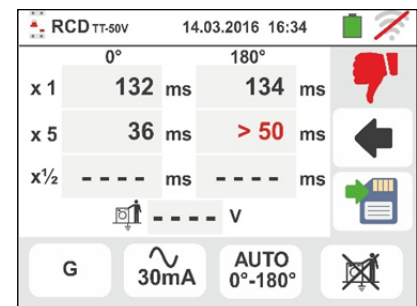

**CAUTION**

According to standard EN61008, the test for Selective differential switches requires an interval of 60 seconds between the tests (30s for tests with 1/2 Idn). The instrument display shows a timer indicating the time remaining before the instrument can automatically perform the test.





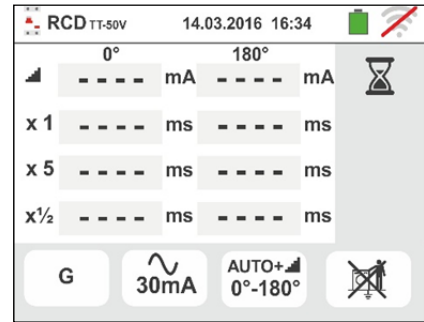

### 6.3.2. AUTO+ mode

9. Press the **GO/STOP** key for few seconds on the instrument or the **START** key on the remote lead. The instrument will start the measurement.

The screen to the side is shown on the display when the hourglass icon indicates the performance of the test.



10 The **AUTO+** mode foresees the automatic execution of 8 measurements in a sequence:

- (Ramp) with phase 0° (the RCD must trip, reset the switch, icon )
- (Ramp) with phase 180° (the RCD must trip, reset the switch, icon )
- IdN x 1 with phase 0° (the RCD must trip, reset the switch, icon )
- IdN x 1 with phase 180° (the RCD must trip, reset the switch, icon )
- IdN x 5 with phase 0° (the RCD must trip, reset the switch, icon )
- IdN x 5 with phase 180° (the RCD must trip, reset the switch, icon )
- IdN x 1/2 with phase 0° (RCD must not trip)
- IdN x 1/2 with 180° (RCD must not trip, end test)

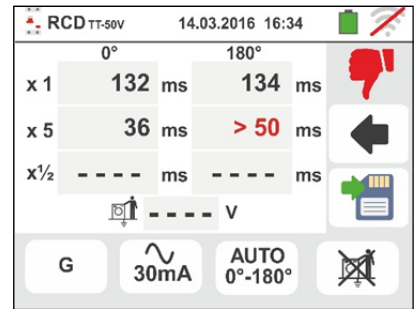

11 The test has a positive result if all tripping times of **molded case type STD** comply with what indicated in Table 6 (see § 13.4). The test has a negative result when one of the values is out of range. During this whole stage, do not disconnect the measuring leads of the instrument from the system on test.

12 At the end of the test, if the tripping time of each test complies with what is indicated in Table 6 (see § 13.4)

the instrument shows the  symbol to signal that the test has been completed successfully, and displays a screen similar to the one reported here to the side.

Press the **SAVE** button or touch the  icon to save the measurement (see § 7.1).

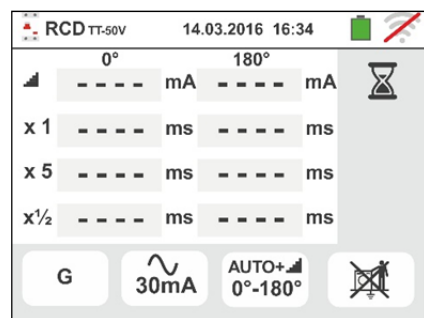

13 At the end of the test, if the tripping time of a test does not comply with what is indicated in Table 6 (see § 13.4).

the instrument shows the  symbol to signal that the test has not been completed successfully, and displays a screen similar to the one reported here to the

side. Press the **SAVE** button or touch the  icon to save the measurement (see § 7.1).

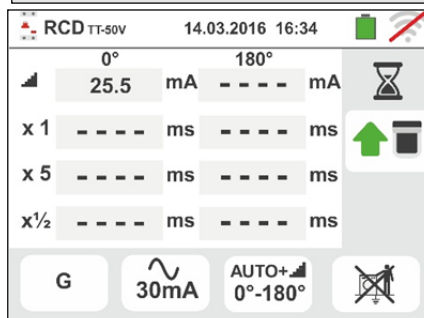

**NOTE: the value of contact voltage is not shows in this test**

### 6.3.3. $x\frac{1}{2}$ , $x1$ , $x2$ , $x5$ modes

9. Press the **GO/STOP** key **for few seconds** on the instrument or the **START** key on the remote lead. The instrument will start the measurement.

The screen to the side (concerning multiplier  $x1$ ) is shown on the display when the hourglass icon indicates the performance of the test.

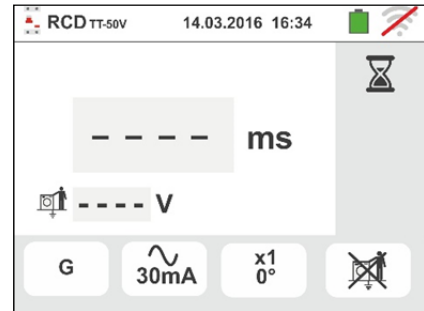



- 10 At the end of the test with multiplier  $x\frac{1}{2}$ ,  $x1$ ,  $x2$  or  $x5$  if the tripping time, for **molded case type STD**, is as listed in Table 6

the instrument shows the  symbol to signal that the test has been completed successfully, and displays a screen similar to the one reported here to the side.

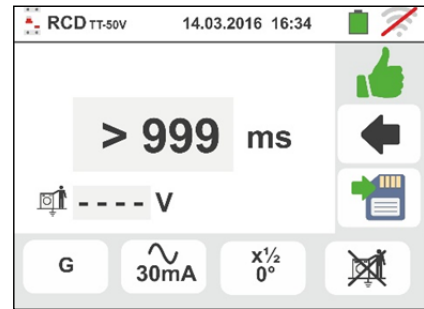
Press the **SAVE** button or touch the  icon to save the measurement (see § 7.1).



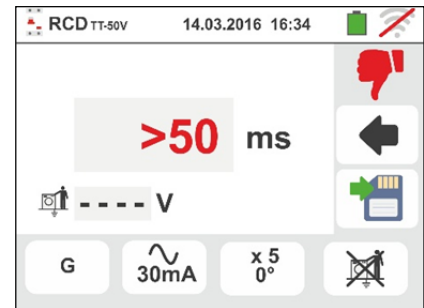

- 11 At the end of the test, for **molded case type STD**, if the tripping time of a test does not comply with what is indicated in Table 6 the instrument shows the  symbol to signal that the test has not been completed successfully, and displays a screen similar to the one reported here to the side.

Press the **SAVE** button or touch the  icon to save the measurement (see § 7.1).





### 6.3.4. Mode $x1$ – Test on RCDs with delay time

9. At the end of the test, if the measured tripping time is within the interval: [**limit delay = set delay time + value indicated in Table 6**] the instrument displays the  symbol to indicate the positive outcome of the test and displays a screen like the one to the side.

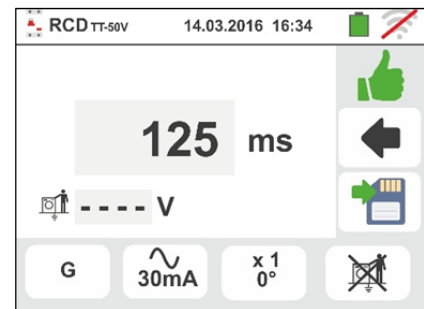
Press the **SAVE** button or touch the  icon to save the measurement (see § 7.1).



- 10 At the end of the test, if the measured tripping time is external the interval: [**limit delay = set delay time + value indicated in Table 6**] the instrument displays the  symbol to indicate the negative outcome of the test and displays a screen like the one to the side.

Press the **SAVE** button or touch the  icon to save the measurement (see § 7.1)

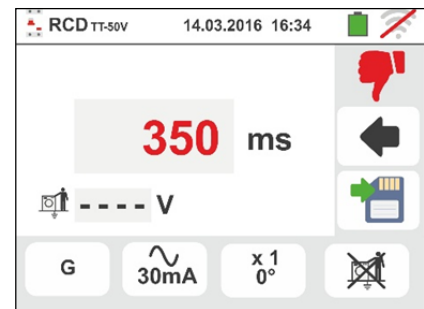

### 6.3.5. Mode

The standard defines, for **molded case type STD**, the tripping times for RCDs at nominal current. The mode is used to detect the minimum tripping current (which could also be lower than the nominal voltage).

9. Press the **GO/STOP** key for few seconds on the instrument or the **START** key on the remote lead. The instrument will start the measurement.

The screen to the side is shown on the display when the hourglass icon indicates the performance of the test.

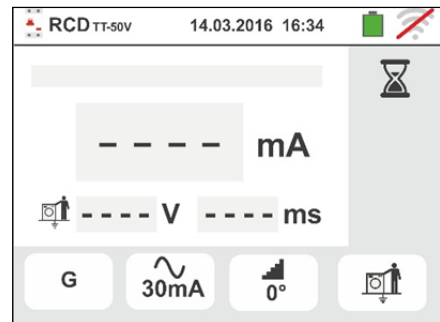

- 10 At the end of the test, if the tripping current is within the values of the table in the relevant § 11.1, the instrument displays the symbol to indicate the positive outcome of the test and displays a screen like the one to the side.

Press the **SAVE** button or touch the icon to save the measurement (see § 7.1).

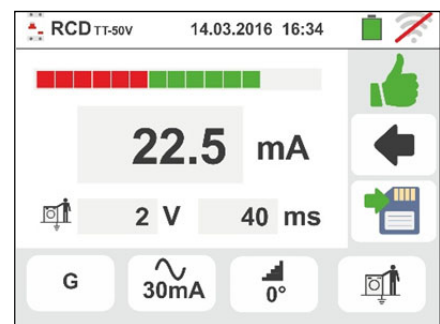

- 11 At the end of the test, if the tripping current is not within the values of the table in the relevant § 11.1, the instrument displays the symbol to indicate the negative outcome of the test and displays a screen like the one to the side.

Press the **SAVE** button or touch the icon to save the measurement (see § 7.1).

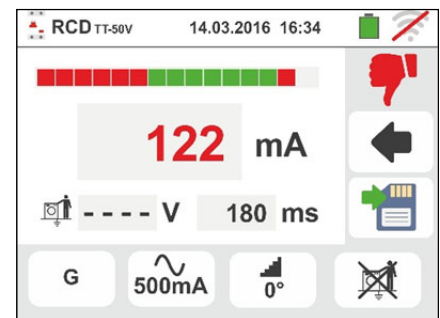

- 12 **For RCD type A and B** it is possible to have a positive outcome also if the result is higher than the selected nominal current. This is due to the “REAL” option visualization selected (see § 6.3 – point 6)

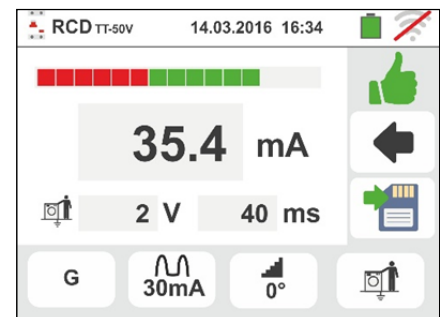



### 6.3.6. Test on earth leakage relay RCD

The instrument allows performing tests on earth leakage relay RCD with currents up to 10A (with optional accessory RCDX10)

- Connect the instrument and the optional accessory **RCDX10** to the installation (see Fig. 17). Pay attention to the connection of cables “1” and “2” of the RCDX10 accessory and to the direction of the current indicated by the arrow printed on the accessory. It is also possible to use the remote lead by inserting its multipolar connector into input lead B1

- Press the **GO/STOP** key for few seconds on the instrument or the **START** key on the remote lead. The instrument will start the measurement.

The screen to the side is shown on the display when the hourglass icon indicates the performance of the test.

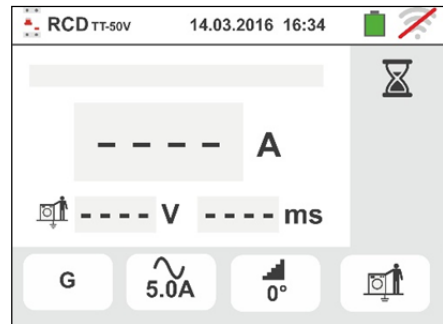

- At the end of the test, if the tripping current is lower to the set value, the instrument displays the  symbol to indicate the positive outcome of the test and displays a screen like the one to the side.

Press the **SAVE** button or touch the  icon to save the measurement (see § 7.1)

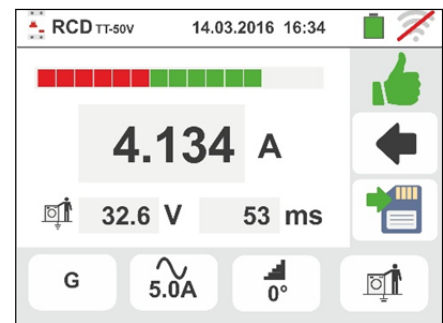

- At the end of the test, if the tripping current is higher to the set value, the instrument displays the  symbol to indicate the negative outcome of the test and displays a screen like the one to the side.

Press the **SAVE** button or touch the  icon to save the measurement (see § 7.1)

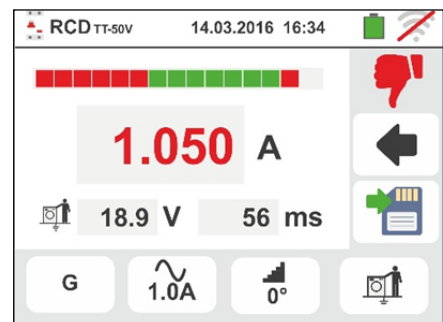



### 6.3.7. Anomalous situations

1. If the voltage between inputs B1 and B4 and inputs B1 and B3 is higher than 265V, the instrument provides the warning screen shown to the side and blocks the execution of the tests.

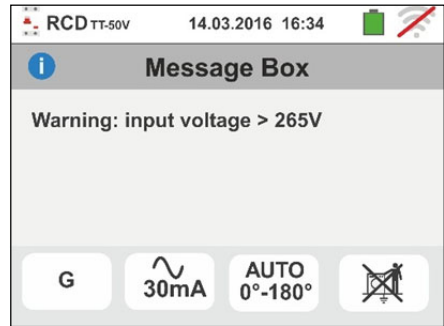

2. If the voltage between inputs B1 and B4 and inputs B1 and B3 is lower than 100V, the instrument provides the warning screen shown to the side and blocks the execution of the tests.

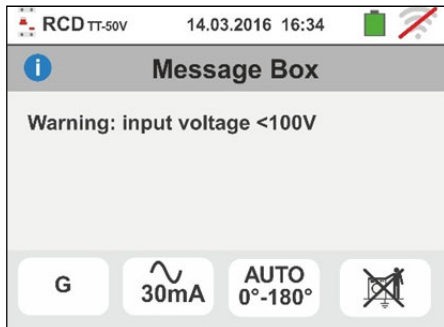

3. If the instrument detects the absence of the signal to terminal B1 (phase conductor), it provides the warning screen shown to the side and blocks the execution of the tests.

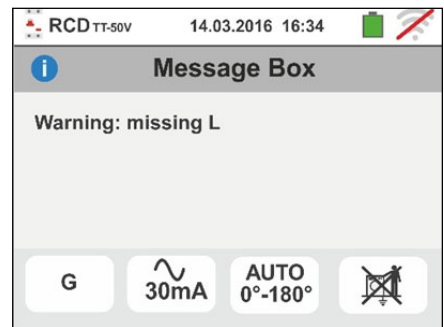

4. If the instrument detects the absence of the signal to terminal B4 (neutral conductor), it provides the warning screen shown to the side and blocks the execution of the tests.

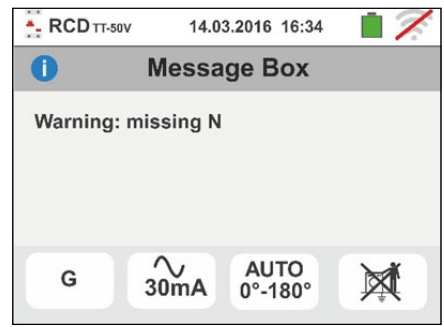

5. If the instrument detects the absence of the signal to terminal B3 (PE conductor), it provides the warning screen shown to the side and blocks the execution of the tests.

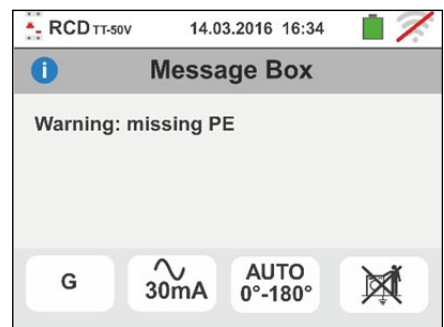

6. If the instrument detects that the phase and neutral leads are inverted, it does not carry out the test and a screen similar to the one reported to the side is displayed. Rotate the shuko plug or check the connection of measuring cables.

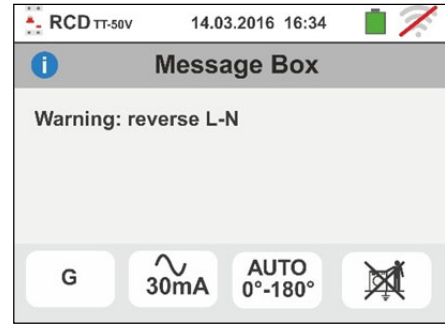

7. If the instrument detects that the phase and PE leads are inverted, it does not carry out the test and a screen similar to the one reported to the side is displayed. Check the connection of measuring cables.

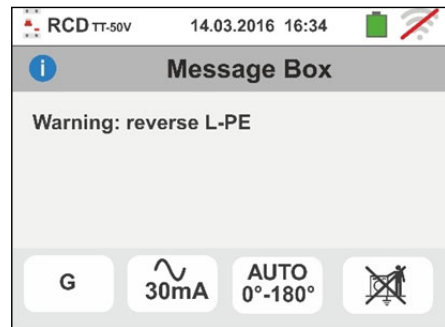

8. If the differential switch being tested trips during the preliminary checks (performed automatically by the instrument before executing the selected test), the instrument does not carry out the test and displays a screen like the one to the side. Check that the IdN set value is consistent with the differential switch in question and that all loads connected downstream of it are disconnected.

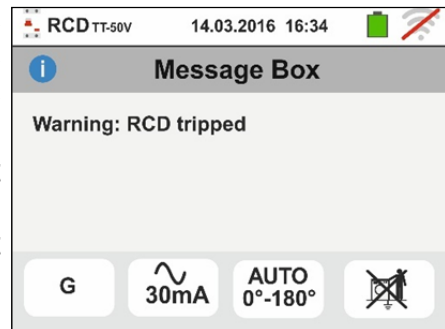

9. If the instrument detects a dangerous voltage on PE conductor it provides the warning screen shown to the side and blocks the execution of the tests. Check the PE conductor and earth plant efficiency. This message can also appear in case of an insufficient pressure of the **GO/STOP** key

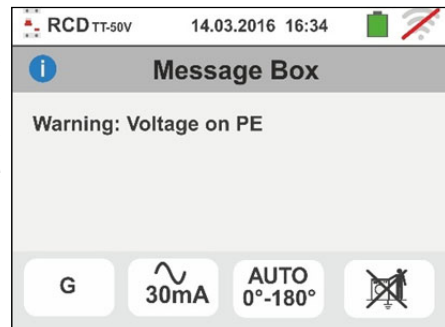

10. If the instrument detects a dangerous contact voltage  $U_t$  (over the set limit 25V or 50V) in the starting pre-test, it provides the warning screen shown to the side and blocks the execution of the tests. Check the PE conductor and earth plant efficiency

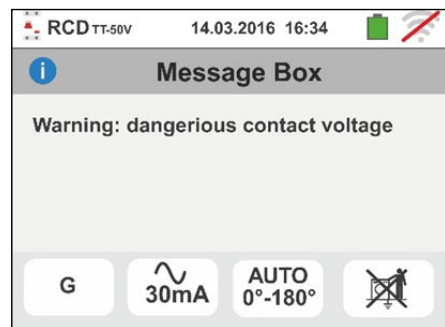

- 11 If the instrument detects a voltage  $V_{n-pe} > 50V$  (or the analogue  $V_{n-pe} > 25V$ ) it provides the warning screen shown to the side and blocks the test for safety reasons. Check the PE conductor and earth plant efficiency

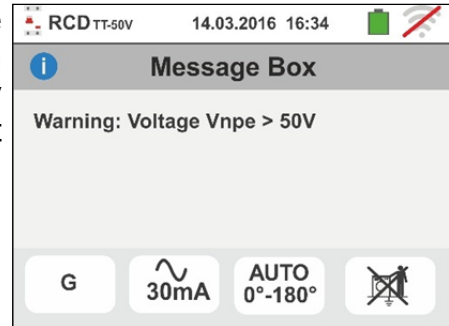

- 12 If the instrument detects in the input terminals a too high external impedance such that it can not provides the nominal current, it provides the warning screen shown to the side and blocks the test. Disconnect the possible loads downstream the LCD before perform the test

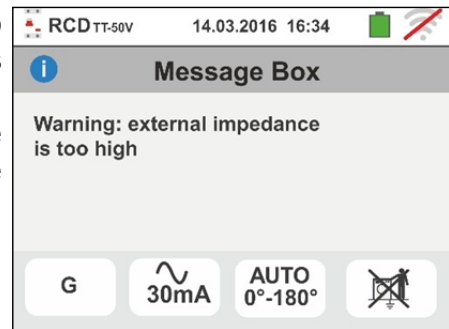

- 13 **For only RCD type B** if the instrument is not able to provide for the charging of the internal capacitors of the RCD, it provides the warning screen shown to the side and blocks the test. Check that the VL-N voltage should be more than 190V

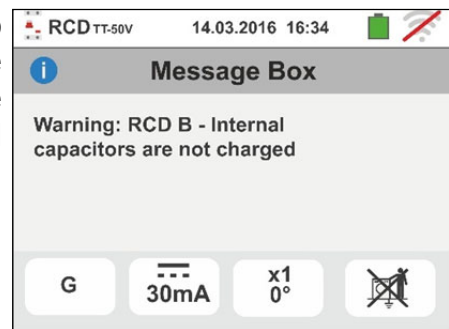

- 14 **For only RCD type B** if the instrument detects a input voltage  $V_{L-N} < 190V$ , it provides the warning screen shown to the side and blocks the test. Check the values of the voltages on the installation

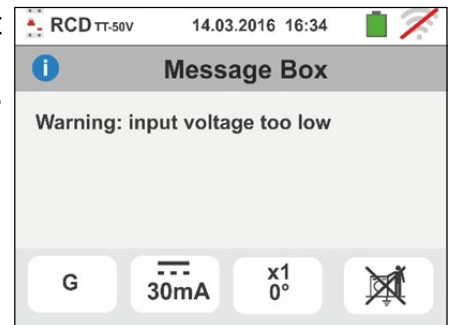

- 15 **For test on earth leakage relay RCD** if the value set for the rated current of the protection device is out of the allowed range, the instrument provides the warning screen shown to the side and stops the tests. Change the value of the rated current of the protection device

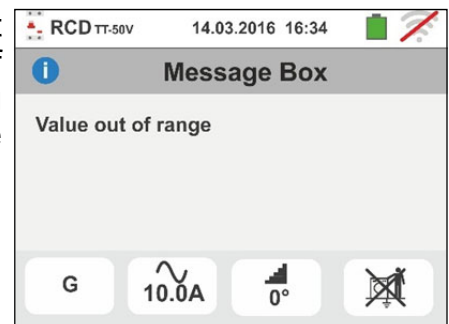

#### 6.4. LOOP: LINE IMPEDANCE/LOOP AND OVERALL EARTH RESISTANCE

This function is performed in compliance with standard IEC/EN61557-3, BS7671 17th edition, AS/NZS 3000, AS/NZS 3017 and allows measuring the line impedance, the fault loop impedance and the prospective short-circuit current.



#### CAUTION

Depending on the selected electrical system (TT, TN or IT) some kind of connection and function modes are disabled by the instruments (see Table 2 )

The following operating modes are available

- L-N** Standard (STD) measurement of the line impedance between the phase conductor and the neutral conductor and calculation of the assumed phase-to-neutral short-circuit current. This measurement is carried out even with high resolution ( $0.1\text{m}\Omega$ ) through the optional accessory IMP57.
- L-L** Standard (STD) measurement of the line impedance between the two phase conductors and calculation of the assumed phase-to-phase short-circuit current. This measurement is carried out even with high resolution ( $0.1\text{m}\Omega$ ) through the optional accessory IMP57.
- L-PE** Standard (STD) measurement of the fault loop impedance between the phase conductor and the earth conductor and calculation of the assumed phase-to-earth short-circuit current. This measurement is carried out even with high resolution ( $0.1\text{m}\Omega$ ) through the optional accessory IMP57.
- No Trip** Loop impedance without causing the protections tripping in TN systems (see § 13.6) and Global earth resistance (TT systems) with and without neutral (see § 13.7).



#### CAUTION

The measurement of line impedance or fault loop impedance involves the circulation of a maximum current according to the technical specifications of the instrument (see § 11.1). This could cause the tripping of possible magnetothermal or differential protections at lower tripping currents.

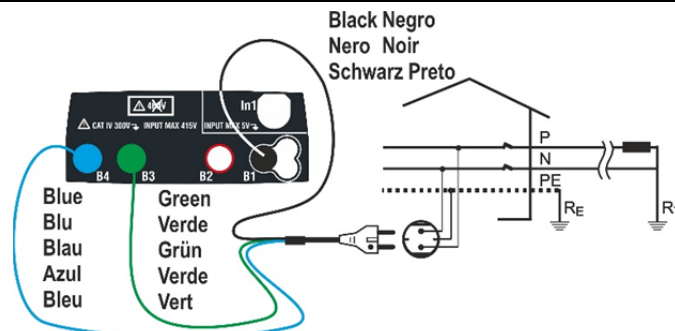

Fig. 18: P-N/P-PE measure for single-phase 230V systems with shuko plug

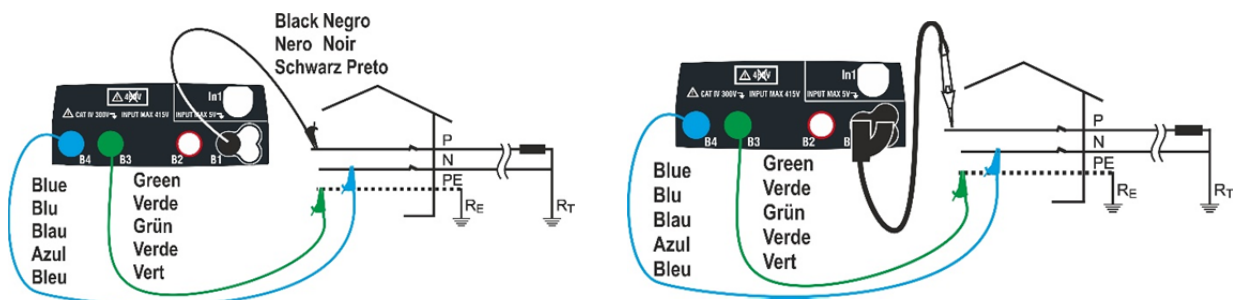

Fig. 19: P-N/P-PE measure for single-phase/two-phase 230V systems with cables and remote lead

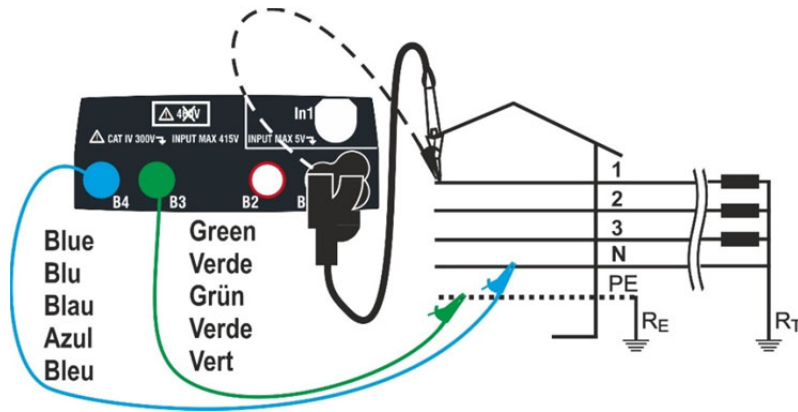

Fig. 20: P-N/P-PE measurement for 400V+N+PE three-phase systems by means of single cables and remote lead

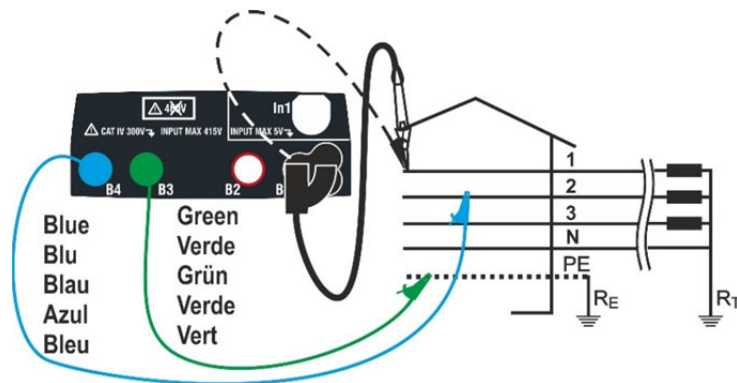

Fig. 21: P-P measurement for 400V+N+PE three-phase systems

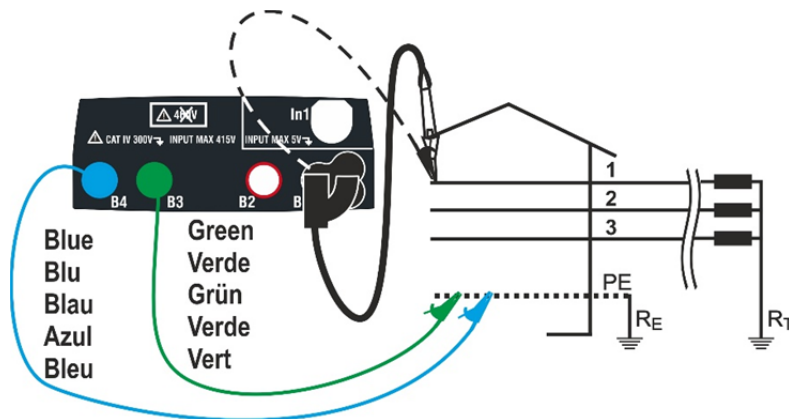

Fig. 22: P-PE/P-N measurement for 400V + PE (no N) systems by means of single cables and remote lead

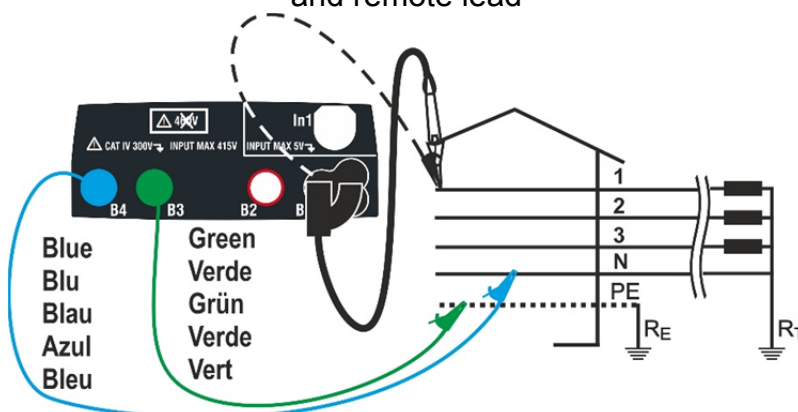

Fig. 23: P-PE measurement for IT systems by means of single cables and remote lead

### 6.4.1. Test types

The protection of electrical lines is the essential part of a project so as to guarantee the correct functionality and avoid damages to persons or property. To this purpose, the safety guidelines impose on electrical designers also to design the electrical installation in order to reach:

1. The protection from short-circuits, that's to say:
  - The breaking capacity of the protection device must be not lower than the supposed short-circuit current in the point in which the device is installed
  - In case of short-circuit in any point of the protected line, the protection device must trip on quickly enough to avoid that the insulation materials assume excessive temperatures
2. The protection from indirect contacts.

In order to verify the a.m. conditions, the instrument performs the following functions:



**Check of protection from indirect contact** – According to the type of distribution system (TT, TN, IT) set by the user, the instrument performs the measurement and verifies the condition imposed by the guidelines. Should it be reached, the instrument gives a positive outcome (see § 13.6, § 13.7, §13.9)

**kA** **Check of protection's breaking capacity** – The instrument detects the value of the line impedance upstream to the measurement point, calculates the maximum value of short-circuit current and gives a positive outcome if the value is lower than the limit set by the user (see § 13.5)

**I<sup>2</sup>t** **Check of protection from short-circuits** – The instrument detects the value of the line impedance upstream to the measurement point, calculates the value of short-circuit current and the corresponding value of the trip out time (t) of the protection device and gives a positive outcome if the value of specific energy passing through the protection device is lower than the specific short-circuit energy bearable by the cables according to the known relationship (see § 13.11):

$$(K * S)^2 \geq I^2 t$$

where K and S are parameters of the cable, set by the user, that's to say:

K= parameter indicated by the guideline depending on the type of conductor material and on the material of the insulating sheath

S = section of the cable

To completion of the above checks, the instrument performs also:



**Check of the coordination of protections** – The instrument detects the value of the line impedance upstream to the measurement point, calculates the minimum value of short-circuit current and the corresponding value of the trip out time (t) of the protection device and gives a positive outcome if the value is lower than the limit set by the user (see § 13.10)

**STD** Generic test

The IMP57 optional accessory allows the instrument to perform both individual and high resolution (0.1mΩ) Line/Loop impedance measurements



The following table summarizes the possible measures executable depending on the type of system (TT, TN and IT), of selected modes and the relationships that define limit values

	Mode	TT	TN	IT
		Condition x OK outcome	Condition x OK outcome	Condition x OK outcome
L-L	STD	No outcome	No outcome	No outcome
	kA	Isc L-L max < BC	Isc L-L max < BC	Isc L-L max < BC
	I <sup>2</sup> t	(Isc L-L 3F) <sup>2</sup> * t < (K * S) <sup>2</sup>	(Isc L-L3F) <sup>2</sup> * t < (K * S) <sup>2</sup>	(Isc L-L3F) <sup>2</sup> * t < (K * S) <sup>2</sup>
		(IscL-Lmin 2F) → Tmax → Tmax < Tlim	(IscL-L min 2F) → Tmax → Tmax < Tlim	(IscL-Lmin 2F) → Tmax → Tmax < Tlim
L-N	STD	No outcome	No outcome	No outcome
	kA	Isc L-N max < BC	Isc L-N max < BC	Isc L-N max < BC
	I <sup>2</sup> t	(Isc L-N) <sup>2</sup> * t < (K * S) <sup>2</sup>	(Isc L-N) <sup>2</sup> * t < (K * S) <sup>2</sup>	(Isc L-N) <sup>2</sup> * t < (K * S) <sup>2</sup>
		(Isc L-N min ) → Tmax → Tmax < Tlim	(Isc L-N min ) → Tmax → Tmax < Tlim	(Isc L-N min ) → Tmax → Tmax < Tlim
L-PE	STD		No outcome	
	kA		Isc L-PE max < BC	
	I <sup>2</sup> t		(Isc L-PE) <sup>2</sup> * t < (K * S) <sup>2</sup>	
			(Isc L-PE min ) → Tmax → Tmax < Tlim	
			Tlim → Ia → Isc L-PE MIN > Ia	Utmeas < Utlim
NoTrip  (No for IMP57)	STD			
	kA			
	I <sup>2</sup> t			
		Isc L-PE MIN > Idn (RCD)	Isc L-PE MIN > Idn (UK, AUS/NZ) ZL-PE < ZLimit (UK, AUS/NZ) I <sub>pf</sub> c with Trip time < Trip time limit (other countries)	

Table 2: Conditions of positive outcome depending on the test parameters

Where:

Empty cells	Not available mode for this particular combination of electric system
Isc L-L_3F	Prospective short circuit current three-phase Phase-Phase (see § 13.5)
Isc L-L_Min2F	Prospective short circuit current minimum two-phase Phase-Phase (see § 13.10)
Isc L-N_Max	Prospective short circuit current maximum Phase-Neutral (see § 13.5)
Isc L-N_Min	Prospective short circuit current minimum Phase-Neutral (see § 13.10)
Isc L-PE_Max	Prospective short circuit current maximum Phase-PE (see § 13.5)
Isc L-PE_Min	Prospective short circuit current minimum Phase-PE (see § 13.10)
BC	Breaking Capacity of the protection device - kA
K	Constant relative to the I <sup>2</sup> t measurement (vedere § 13.11)
Z Limit	Max allowed limit impedance compliance with type of protection (see § 13.7)
S	Section of conductor
Tmax	Maximum trip out time of the protection device
Tlim	Limit time of fault extinction by the protection set by the user
Ut meas	Contact voltage measured
Ut lim	Contact voltage limit (25V or 50V)
Ra meas	Global earth resistance measured
Idn	Trip out current of RCD devices
I <sub>pf</sub> c	Prospective fault current

### 6.4.2 Test leads calibration (ZEROLOOP)

In order to obtain better results, it is strongly recommended to perform the preliminary calibration of the test cables or the cable with Shuko plug by using the **ZEROLOOP** accessory before performing the test. In this way the instrument automatically subtracts the resistance of the test cables, providing the effective result on the display. By way of example, the procedure for the LOOP STD Generic mode is described as follows and can be extended to all other cases.

1. Touch the icon. The screen to the side appears on the display. Touch the icon to enter into the test leads calibration section. The following screen appears on the display

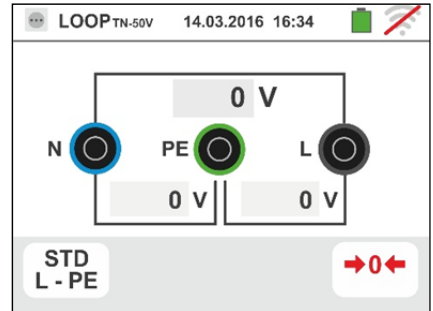

2. Touch the icon in order to select the test leads calibration or the icon to select the cable with Shuko plug calibration as shown in the following screen

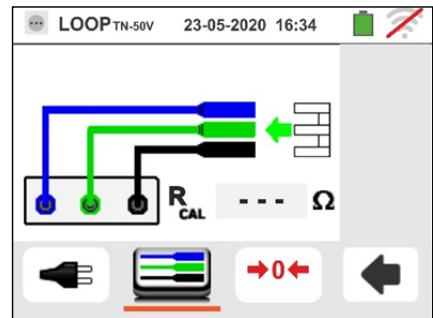

3. Insert the **ZEROLOOP** metallic accessory into the three banana connectors of the measurement cables (L-N-PE) or into the metal connectors of the Shuko plug (differently in the various types depending on the country of use) as shown in the following

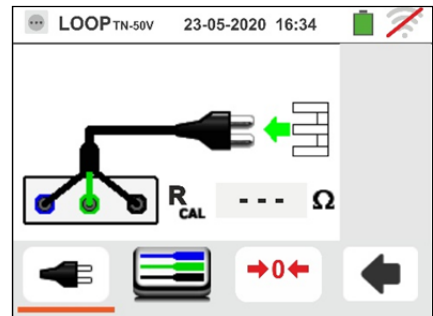

Test leads	SHUKO plug	UK plug	ITA plug	SWI plug	DEN plug	AUS/CHN plug	USA plug

Table 3: Connection of ZEROLOOP accessory

4. Touch the icon to start the calibration. In the **R<sub>CAL</sub>** field the resistance of test leads is shown. This value will be automatically subtracted by the instrument at the end of Loop measurement

The instrument displays the symbol to indicate the positive outcome of test leads calibration (**R<sub>cal</sub> < 1Ω**) and the screen to the side appears on the display

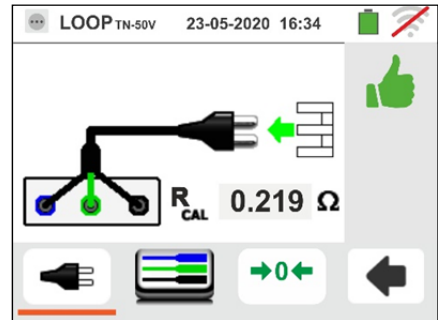

5. Touch the icon to back to the measurement main screen. Note the green icon which means the successful test leads calibration and proceed with the measurements described in the following paragraphs

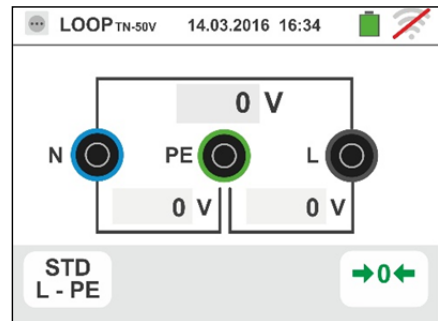

6. The value of the test leads/Shuko plug resistance various plugs is maintained by the instrument up to the reset operation performed by the user (for example for the insertion of cables with different lengths). To perform the reset of saved calibration value, touch the icon. The screen to the side appears on the display

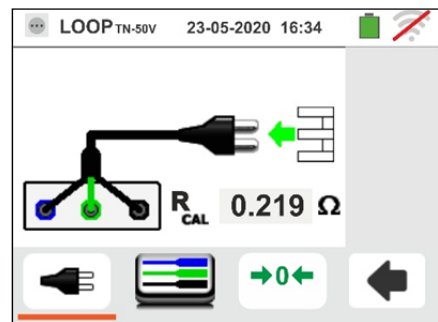

7. With open input terminals touch the icon. The "> 1Ω" indication is shown for a while in the **R<sub>CAL</sub>** field and the "Calibration Reset..." is shown at display.

Touch the icon to back to the previous screen (note the " - - " indication in the **R<sub>CAL</sub>** field) and repeat the previous steps in order to perform a new calibration





### 6.4.3 STD Mode – Generic test

This mode performs the impedance measurement and the calculation of prospective short circuit current without applying any evaluation. Therefore, at the end of the test, no outcome is given by the instrument.

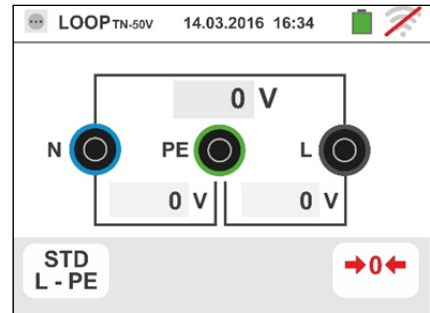
1. Select the options “TN, TT or “IT”, “25 or 50V”, “50Hz or 60Hz” and the reference voltage in the general settings of the instrument (see § 5.1.4). Touch the  icon. The screen to the side appears on the display. Touch the lower icon. The following screen appears on the display:



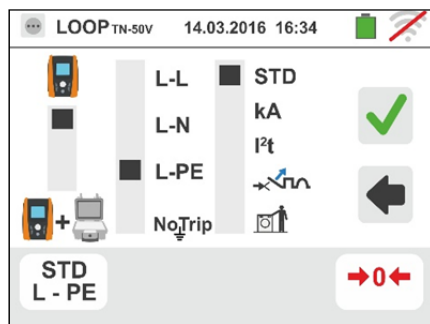

2. Move the left slide bar reference by selecting the  icon to execute the measurement only with the instrument or the  icon to execute the measurement with the instrument + optional accessory IMP57 (see § 6.4.13). Move the central slide bar reference by selecting the "L-L, L-N or L-PE" options. Move the right slide bar reference by selecting the "STD" option. Confirm the choice by going back to the previous screen.

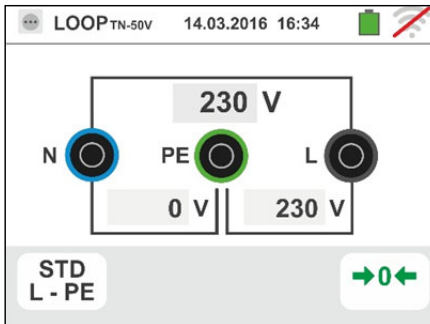

3. If possible, disconnect all loads connected downstream of the measuring point, as the impedance of these users could distort the test results.
4. Perform the preliminary calibration of the test leads as described in § 6.4.2. Connect the shuko plug, the alligator clips or the remote lead to the electrical mains according to Fig. 18, Fig. 19, Fig. 20 and Fig. 22.

5. Note the presence of the correct voltage values between L-N and L-PE corresponding to the selections carried out in the initial phase (see § 5.1.4) as shown in the screen to the side. Press the **GO/STOP** key for few seconds or the **START** key on the remote lead. During this whole stage, do not disconnect the measuring leads of the instrument from the system under test. The following screen appears on the instrument's display:



6. The value of the assumed short-circuit current (I<sub>sc</sub>) is shown in the upper part of the display, while the Line/Loop Z<sub>PE</sub> impedance is shown at the bottom of the display. Press the **SAVE** button or touch the  icon to save the measurement (see § 7.1).

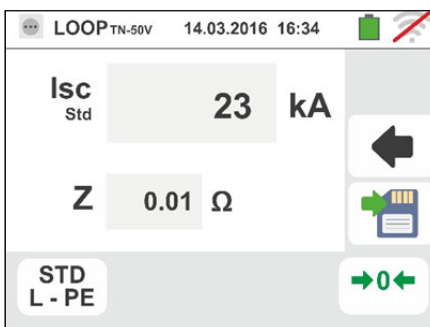

The Standard (Std) assumed short-circuit current (I<sub>sc</sub>) is calculated using the following formula:

$$I_{SC} = \frac{U_{NOM}}{Z_{MEAS}}$$

Z<sub>MEAS</sub> = measured L-L,L-N,L-PE loop impedance

U<sub>NOM</sub> = nominal voltage (depend on the system)

### 6.4.4. Mode kA – Verify of breaking capacity of protection device

1. Select the options “TN, TT or “IT”, “25 or 50V”, “50Hz or 60Hz” and the reference voltage in the general settings

of the instrument (see § 5.1.4). Touch the icon. The screen to the side appears on the display. Touch the lower icon. The following screen appears on the display:

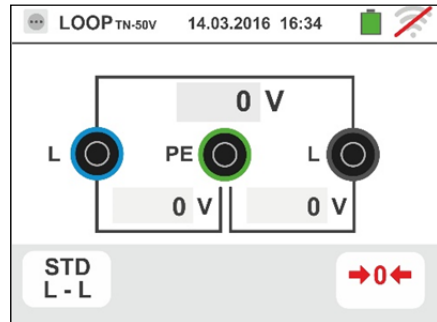

2. Move the left slide bar reference by selecting the icon to execute the measurement only with the instrument or the icon to execute the measurement with the instrument + optional accessory IMP57 (see § 6.4.13). Move the central slide bar reference by selecting the “L-L”, “L-N” or “L-PE” options (for TN systems only). Move the right slide bar reference by selecting the “kA” option.

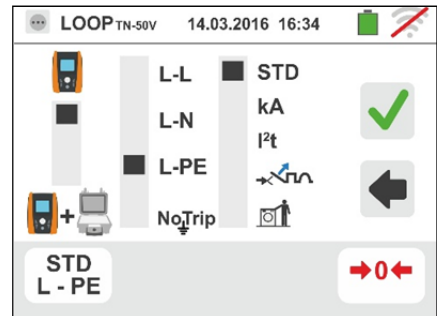

Touch the icon in the lower right corner to set the maximum tripping current expressed in "kA" that the protection must interrupt. The following screen appears on the display:

3. Touch the icon to zero the value in the kA field and use the virtual keyboard to set the value of the breaking capacity of the protection between **1kA** and **9999kA**

Confirm the choice by going back to the initial measurement screen.

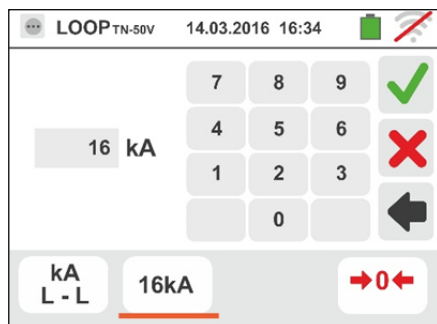

4. If possible, disconnect all loads connected downstream of the measured point, as the impedance of these users could distort the test results. Perform the preliminary calibration of the test leads as described in § 6.4.2 Connect the shuko plug, the alligator clips or the remote lead to the electrical mains according to Fig. 18, Fig. 19, Fig. 20 and Fig. 22 in the nearest possible point to the protection device

Note the presence of the correct voltage values between L-L and L-PE corresponding to the selections carried out in the initial phase (see § 5.1.4) as shown in the screen to the side.

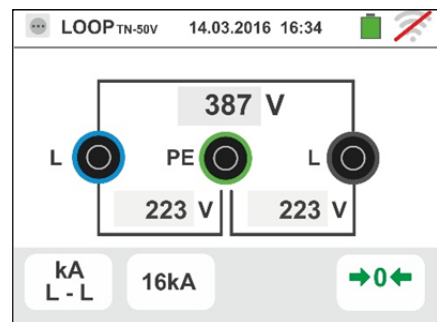

5. Press the **GO/STOP** key for few seconds or the **START** key on the remote lead. During this whole stage, do not disconnect the measuring leads of the instrument from the system under test.

In case of positive outcome, the screen to the side is shown by the instrument.

Press the **SAVE** button or touch the  icon to save the measurement (see § 7.1).

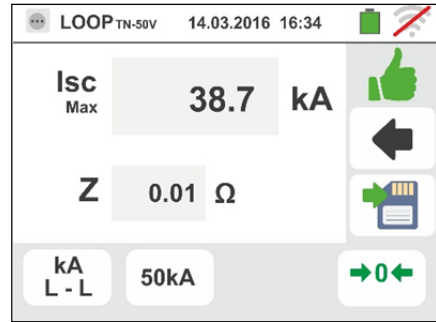

6. In case of test failure (measured Isc Max current > set threshold), the screen to the side is displayed by the instrument.

Note the presence of the measurement result highlighted in red.

Press the **SAVE** button or touch the  icon to save the measurement (see § 7.1).

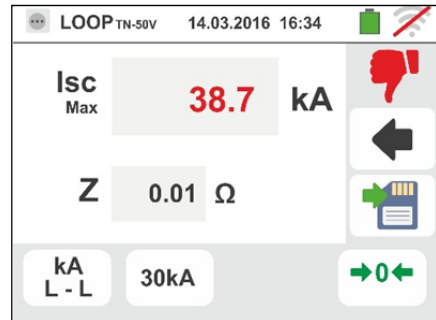



### 6.4.5. Mode $I^2t$ – Verify of protection against short-circuit



CAUTION

The verify of conductor protection against the thermic effect of short-circuit is performed under the following conditions:

- Ambient temperature of 25°C
- Presence of external insulation (not live conductor)
- No harmonics
- Short-circuit at the beginning of the line or at the end of the line without any overload protection
- Not buried cable

The verify performed by the instrument DOES NOT replace in any case the project calculations

1. Select the options “TN, TT or “IT”, “25 or 50V”, “50Hz or 60Hz” and the reference voltage in the general settings of the instrument (see § 5.1.4).

Touch the icon. The screen to the side appears on the display.

Touch the lower icon. The following screen appears on the display:

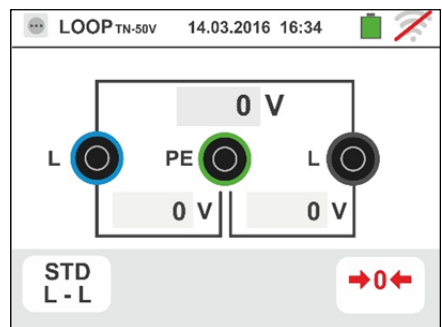

2. Move the left slide bar reference by selecting the icon to execute the measurement only with the instrument or the icon to execute the measurement with the instrument + optional accessory IMP57 (see § 6.4.13).

Move the central slide bar reference by selecting the “L-L”, “L-N” or “L-PE” options (for TN systems only).

Move the right slide bar reference by selecting the “ $I^2t$ ” option.

Touch the icon in the bottom center to set the protection type and its rated current. The following screen appears on the display:

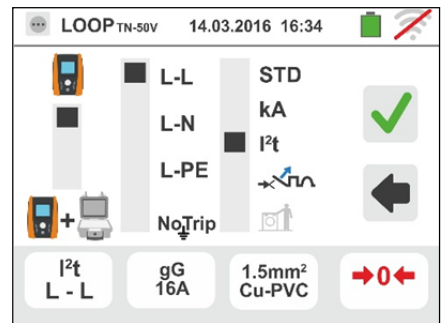

3. Move the slide bar reference by selecting the type of protection (Fuse of type **gG** or **aM** or magnetothermal MCB in curve **B**, **C**, **K**, **D**).

Touch the “In” field. The following screen appears on the display:

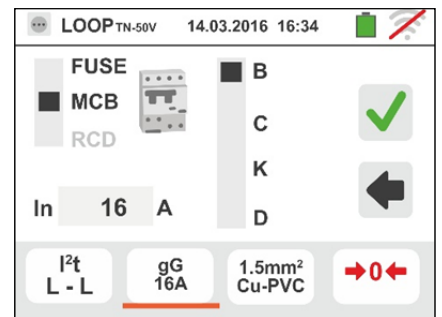

4. Touch the icon to zero the value in the In field and use the virtual keyboard to set the value of the RCD rated current within the values allowed by the instrument.

The following selections are available on the instrument

- MCB current (B curve) selectable among: **3,6,10,13,15,16,20,25,32,40,45,50,63,80, 100,125,160,200A**
- MCB current (C, K, D curves) selectable among: **0.5,1,1.6,2,3,4,6,10,13,15,16,20,25,32,40,50,63, 80,100,125,160,200A**
- Nominal current Fuse gG selectable among: **2, 4, 6, 8, 10, 12, 13, 16, 20, 25, 32, 40, 50, 63, 80, 100, 125, 160, 200, 250, 315, 400, 500, 630, 800, 1000, 1250A**
- Nominal current Fuse aM selectable among: **2, 4, 6, 8, 10, 12, 16, 20, 25, 32, 40, 50, 63, 80, 100, 125, 160, 200, 250, 315, 400, 500, 630A**

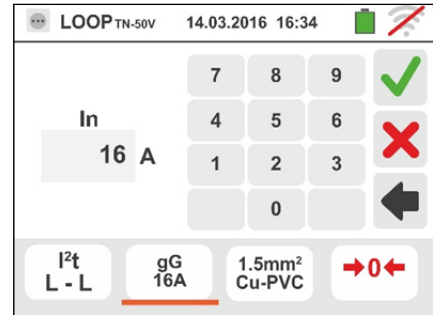

Confirm the choice by going back to the previous screen.

Touch the icon in the bottom right corner to set the type, section and material forming the inner insulation of the cable of the line under test. The following screen appears on the display:

5. Touch the “mm<sup>2</sup>” field and, by using the virtual keyboard, set and confirm the section value of the single cable free selectable

Touch the field “” and, by using the virtual keyboard, set and confirm the possible number of parallel cords. In the case that the circuit have only one conductor set the “1” value

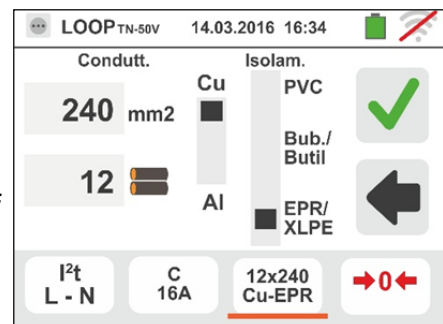

Move the central slide bar reference by selecting the type of conductor. The available options are **Cu** (Copper) and **Al** (Aluminum).

Move the right slide bar reference by selecting the insulation type of the cable between the options: **PVC**, **Rub/Butil** (Rubber/Butyl rubber) and **EPR/XLPE** (Ethylene propylene rubber/Cross-linked polyethylene)

Confirm the choice by going back to the initial measurement screen.

6. If possible, disconnect all loads connected downstream of the measured point, as the impedance of these users could distort the test results. Perform the preliminary calibration of the test leads as described in § 6.4.2 Connect the shuko plug, the alligator clips or the remote lead to the electrical mains according to Fig. 18, Fig. 19, Fig. 20 and Fig. 22. Note the presence of the correct voltage values between L-L and L-PE corresponding to the selections carried out in the initial phase (see § 5.1.4) as shown in the screen to the side

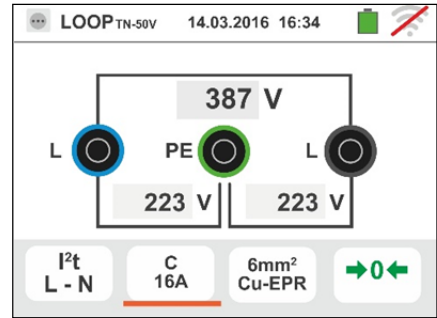

7. Press the **GO/STOP** key for few seconds or the **START** key on the remote lead. During this whole stage, do not disconnect the measuring leads of the instrument from the system under test.

In case of positive result (three-phase short-circuit current for the L-L case in the image supported by the cable with the performed selections), the screen to the side is displayed by the instrument.

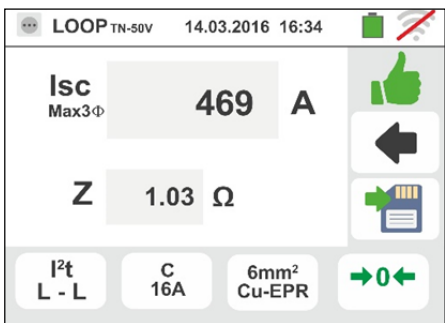

Press the **SAVE** button or touch the  icon to save the measurement (see § 7.1).

8. In case of negative result (three-phase  $I_{sc}$  current for the L-L case in the image NOT supported by the cable with the performed selections), the screen to the side is displayed by the instrument.

Note the presence of the measurement result highlighted in red.

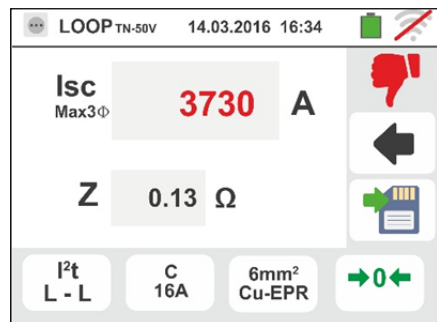

Press the **SAVE** button or touch the  icon to save the measurement (see § 7.1).

6.4.6. **Mode - Verify of protection coordination**

1. Select the reference country (see § 5.1.2), the options “TN, TT or “IT”, “25 or 50V”, “50Hz or 60Hz” and the reference voltage in the general settings of the instrument (see § 5.1.4). **NOTE: for “USA” country the TT and IT systems are not available**

Touch the icon. The screen to the side appears on the display.

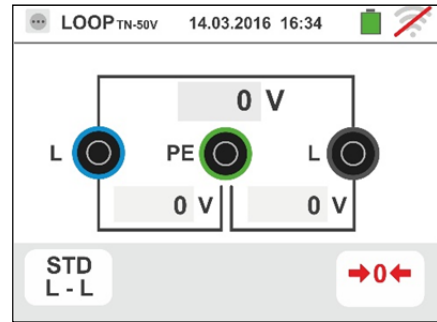

Touch the lower icon. The following screen appears on the display:

2. Move the left slide bar reference by selecting the icon to execute the measurement only with the instrument or the icon to execute the measurement with the instrument + optional accessory IMP57 (see § 6.4.13).

Move the central slide bar reference by selecting the “L-L”, “L-N” or “L-PE” options (for TN systems only).

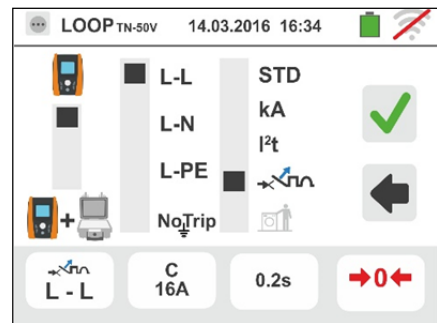

Move the right slide bar reference by selecting the "" option.

Touch the icon in the bottom center to set the protection type and its rated current. The following screen appears on the display:

3. Move the slide bar reference by selecting the type of protection (Fuse of type **gG** or **aM** or magnetothermal MCB in curve **B, C, K, D**), (Fuse of type **BS88-2, BS88-3, BS3036, BS1362** or magnetothermal MCB in curve **B, C, D – UK country**). For **AUS/NZ** country magnetothermal MCB in curve **B, C, D**

Touch the “In” field. The following screen appears on the display:

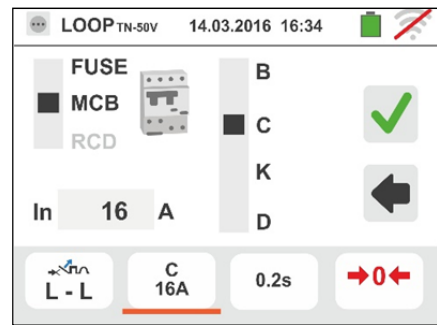

4. Touch the icon to zero the value in the In field and use the virtual keyboard to set the value of the RCD rated current within the values allowed by the instrument.

Confirm the choice by going back to the previous screen.

Touch the icon in the lower right corner to set the tripping time of the RCD. The following screen appears on the display:

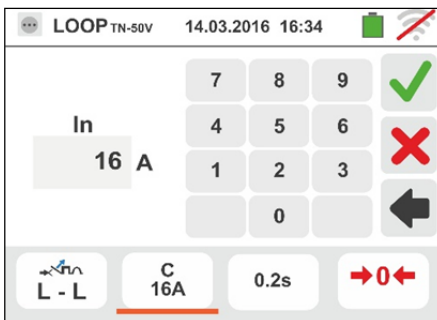

5. Move the slide bar reference by selecting the protection tripping time between the options: **0.1s**, **0.2s**, **0.4s**, **1s**, **5s** (all countries except AUS/NZ and UK), **0.4s**, **5s** (option L-PE, Fuse protection for AUS/NZ and UK) and **0.4s** (option L-PE, MCB protection for AUS/NZ).

Confirm the choice by going back to the initial measurement screen.

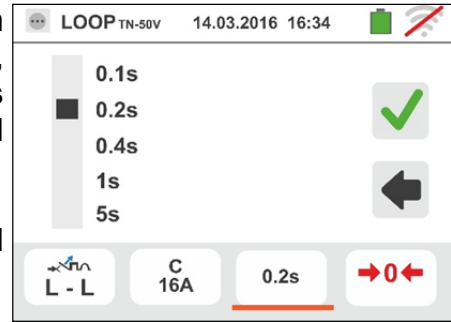

6. If possible, disconnect all loads connected downstream of the measured point, as the impedance of these users could distort the test results. Perform the preliminary calibration of the test leads as described in § 6.4.2 Connect the shuko plug, the alligator clips or the remote lead to the electrical mains according to Fig. 18, Fig. 19, Fig. 20 and Fig. 22 in the farthest possible point respect the protection on test

Note the presence of the correct voltage values between L-L and L-PE corresponding to the selections carried out in the initial phase (see § 5.1.4) as shown in the screen to the side.

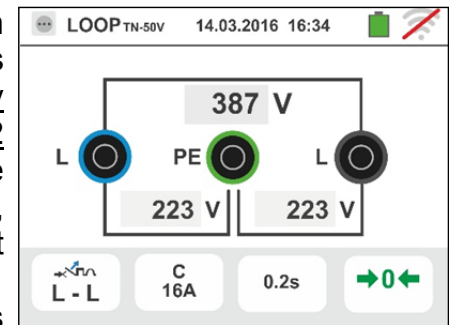

7. Press the **GO/STOP** key for few seconds or the **START** key on the remote lead. During this whole stage, do not disconnect the measuring leads of the instrument from the system under test.

In case of positive result (minimum short-circuit current interrupted by the protection device within the time indicated by the performed selections), the screen to the side is displayed by the instrument.

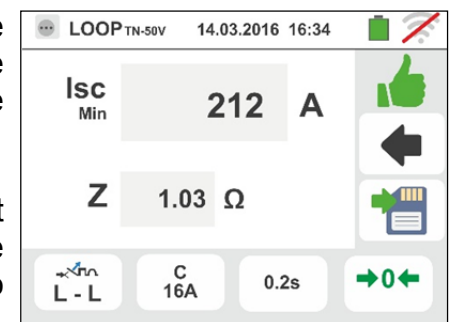

Press the **SAVE** button or touch the  icon to save the measurement (see § 7.1).

8. In case of negative result (minimum short-circuit current NOT interrupted by the protection device within the time indicated by the performed selections), the screen to the side is displayed by the instrument.

Note the presence of the measurement result highlighted in red.

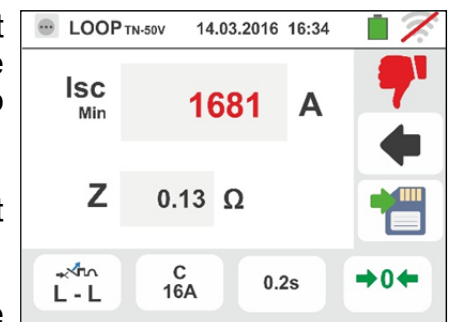

Press the **SAVE** button or touch the  icon to save the measurement (see § 7.1).

6.4.7. **Mode - Verify of protection coordination – Norway country**

1. Select the “Norway” country (see § 5.1.2), the options “TN, or “IT”, “25 or 50V”, “50Hz or 60Hz” and the reference voltage in the general settings of the instrument (see § 5.1.4)

Touch the lower first icon. The following screen appears on the display.

:

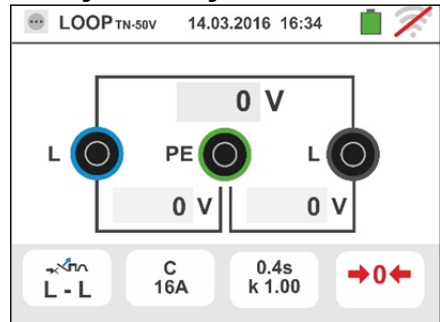

2. Move the left slide bar reference by selecting the icon to execute the measurement only with the instrument or the icon to execute the measurement with the instrument + optional accessory IMP57 (see § 6.4.13).

Move the central slide bar reference by selecting the “L-L”, “L-N” or “L-PE” options (for TN systems only).

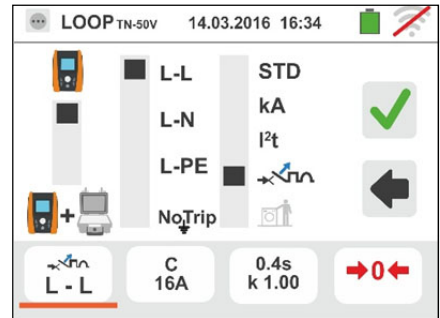

Move the right slide bar reference by selecting the “” option.

Touch the second icon to set the protection type and its rated current. The following screen appears on the display:

3. Move the slide bar reference by selecting the type of protection (Fuse of type **gG** or **aM** or magnetothermal MCB in curve **B**, **C**, **K**, **D**).

Touch the “In” field. The following screen appears on the display:

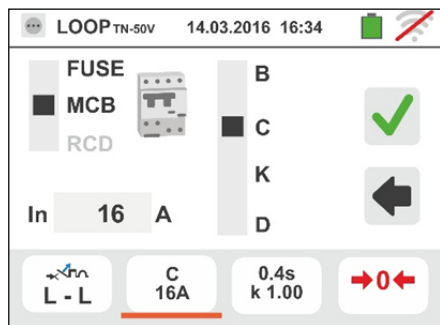

4. Touch the icon to zero the value in the In field and use the virtual keyboard to set the value of the RCD rated current within the values allowed by the instrument.

Confirm the choice by going back to the previous screen.

Touch the third icon to set the tripping time of the RCD. The following screen appears on the display:

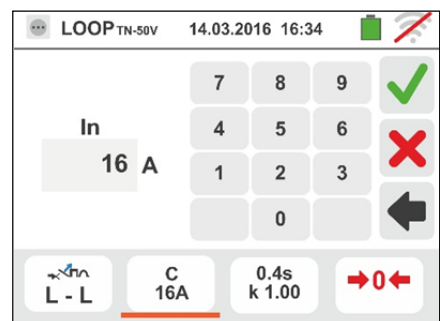



5. Move the slide bar reference by selecting the protection tripping time between the options: **0.1s**, **0.2s**, **0.4s**, **1s**, **5s**. Confirm the choice by going back to the initial measurement screen.

Touch the “k I<sub>sc</sub>” field to set the calculation coefficient of the short circuit current **I<sub>sc</sub>**. The following screen appears on the display

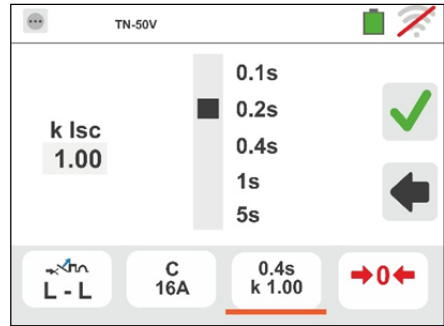

6. Touch the icon to zero the value in the field and use the virtual keyboard to set the calculation coefficient of the short circuit current **I<sub>sc</sub>** within the values allowed by the instrument

Confirm the choice by going back to the initial measurement screen

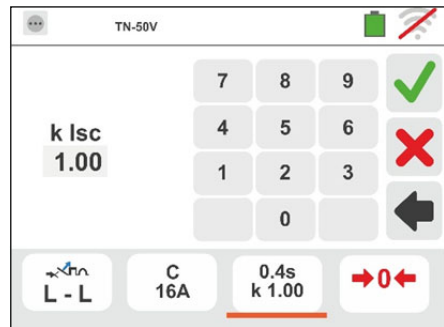

7. If possible, disconnect all loads connected downstream of the measured point, as the impedance of these users could distort the test results. Perform the preliminary calibration of the test leads as described in § 6.4.2 Connect the shuko plug, the alligator clips or the remote lead to the electrical mains according to Fig. 18, Fig. 19, Fig. 20 and Fig. 22 in the farthest possible point respect the protection on test. Note the presence of the correct voltage values between L-L and L-PE corresponding to the selections carried out in the initial phase (see § 5.1.4) as shown in the screen to the side.

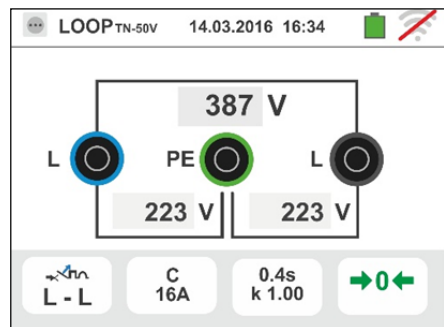

8. Press the **GO/STOP** key for few seconds or the **START** key on the remote lead. During this whole stage, do not disconnect the measuring leads of the instrument from the system under test.

In case of positive result (minimum short-circuit current interrupted by the protection device within the time indicated by the performed selections), the screen to the side is displayed by the instrument.

Press the **SAVE** button or touch the icon to save the measurement (see § 7.1).

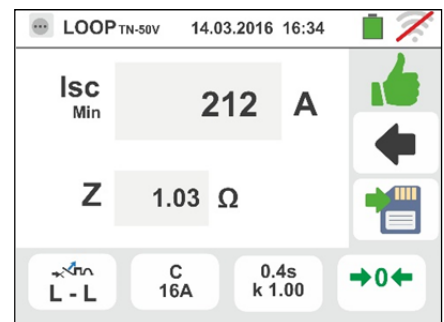

9. In case of negative result (minimum short-circuit current NOT interrupted by the protection device within the time indicated by the performed selections), the screen to the side is displayed by the instrument. Note the presence of the measurement result highlighted in red.

Press the **SAVE** button or touch the icon to save the measurement (see § 7.1).

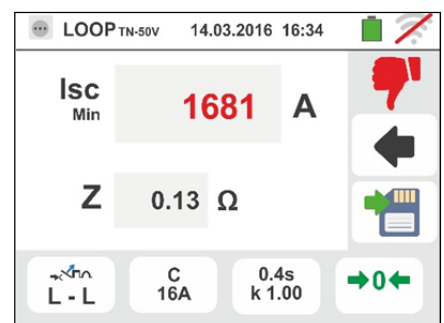

### 6.4.8. Verify of protection against indirect contacts (TN system)

1. Select the options "TN", "25 or 50V", "50Hz or 60Hz" and the reference voltage in the general settings of the instrument (see § 5.1.4).

Touch the  icon. The screen to the side appears on the display.

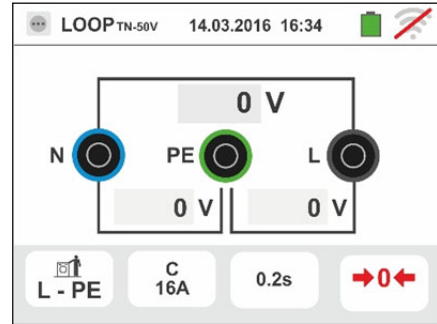

Touch the lower icon. The following screen appears on the display:

2. Move the left slide bar reference by selecting the  icon to execute the measurement.

Move the central slide bar reference by selecting the "L-PE" option. The right slide bar reference is automatically set in position .

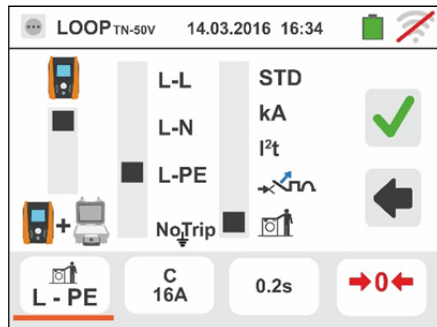

Confirm the choice by going back to the initial measurement screen.

3. Move the slide bar reference by selecting the type of protection (Fuse of type **gG** or **aM** or magnetothermal MCB in curve **B, C, K, D**), (Fuse of type **BS88-2, BS88-3, BS3036, BS1362** or magnetothermal MCB in curve **B, C, D – UK country**). For **AUS/NZ** country magnetothermal MCB in curve **B, C, D**.

Touch the "In" field. The following screen appears on the display

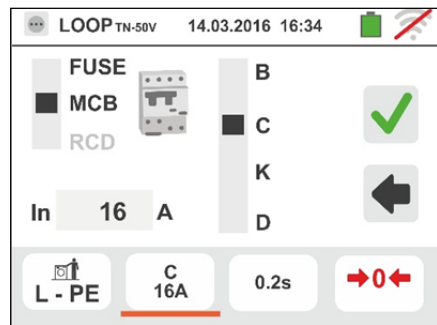

4. Touch the  icon to zero the value in the In field and use the virtual keyboard to set the value of the nominal current of the protection within the values allowed by the instrument (see § 6.4.5)

Confirm the choice by going back to the previous screen.

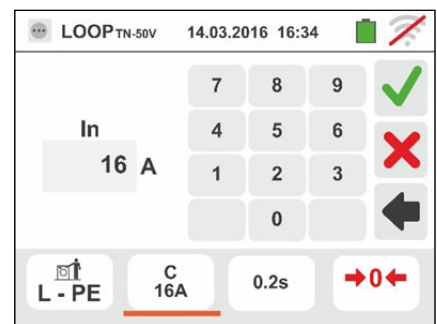

Touch the icon in the lower right corner to set the tripping time of the protection. The following screen appears on the display

5. Move the slide bar reference by selecting the protection tripping time between the options: **0.1s, 0.2s, 0.4s, 1s, 5s** (all countries except AUS/NZ and UK), **0.4s, 5s** (Fuse protection for AUS/NZ and UK) and **0.4s** (MCB protection for AUS/NZ)

Confirm the choice by going back to the initial measurement screen

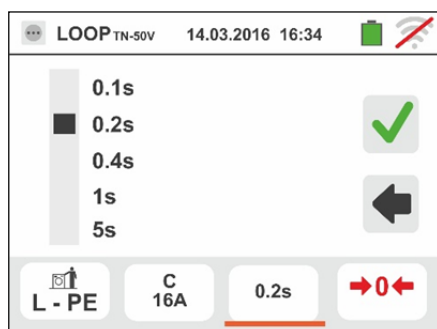

6. If possible, disconnect all loads connected downstream of the measured point, as the impedance of these users could distort the test results. Perform the preliminary calibration of the test leads as described in § 6.4.2 Connect the alligator clips or the remote lead to the electrical mains according to Fig. 18, Fig. 19, Fig. 20 and Fig. 22 in the farthest possible point respect the protection on test.

Note the presence of the correct voltage values between L-N and L-PE corresponding to the selections carried out in the initial phase (see § 5.1.4) as shown in the screen to the side.

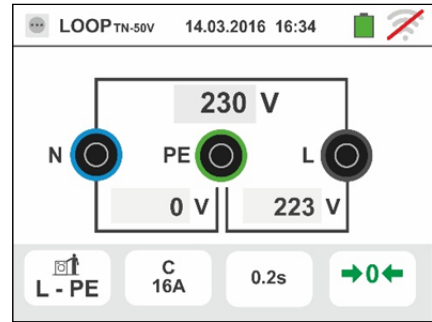

7. Press the **GO/STOP** key for few seconds or the **START** key on the remote lead. During this whole stage, do not disconnect the measuring leads of the instrument from the system under test.

In case of positive result (calculated minimum short-circuit current HIGHER than tripping current of the protection device within the specified time – see § 13.6), the screen to the side is displayed by the instrument

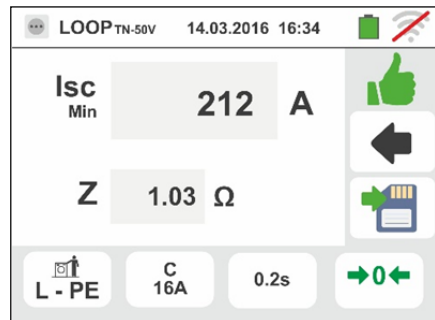

Press the **SAVE** button or touch the  icon to save the measurement (see § 7.1).

8. In case of negative result (calculated minimum short-circuit current LOWER than tripping current of the protection device within the specified time – see § 13.6), the screen to the side is displayed by the instrument

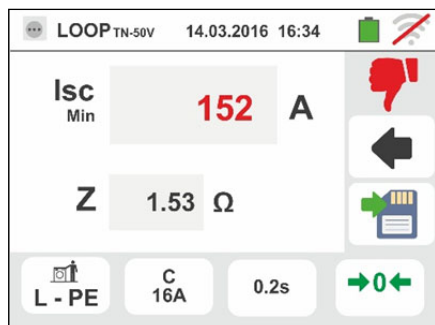

Press the **SAVE** button or touch the  icon to save the measurement (see § 7.1).

### 6.4.9. Verify of protection against indirect contacts (NoTrip $\frac{1}{t}$ test)

1. Select the options "TN", "25 or 50V", "50Hz or 60Hz" and the reference voltage in the general settings of the instrument (see § 5.1.4).

Touch the icon. The screen to the side appears on the display.

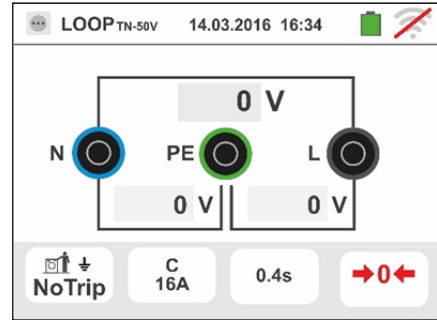

Touch the lower icon. The following screen appears on the display:

2. Move the left slide bar reference by selecting the icon to execute the measurement.

Move the central slide bar reference by selecting the "NoTrip  $\frac{1}{t}$ " option. The right slide bar reference is automatically set in position .

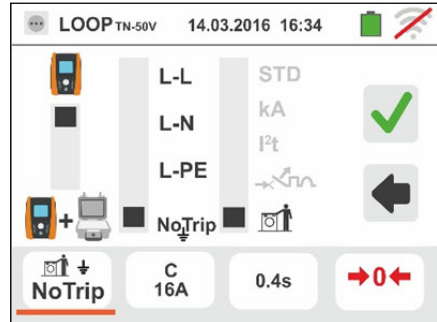

Confirm the choice by going back to the initial measurement screen.

3. Move the slide bar reference by selecting the type of protection (Fuse of type **aM**, **gG**, magnetothermal MCB in curve **B**, **C**, **K**, **D** or nominal trip out currents **10**, **30**, **100**, **300**, **500**, **650**, **1000mA** for **RCD** protection devices. For **AUS/NZ** country magnetothermal MCB in curve **B**, **C**, **D**

Touch the "In" field. The following screen appears on the display

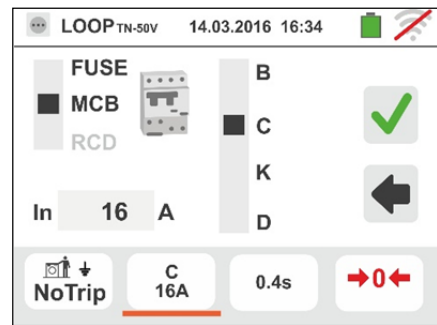

4. Touch the icon to zero the value in the In field and use the virtual keyboard to set the value of the nominal current of the protection within the values allowed by the instrument (see § 6.4.5)

Confirm the choice by going back to the previous screen.

Touch the icon in the lower right corner to set the tripping time of the protection. The following screen appears on the display

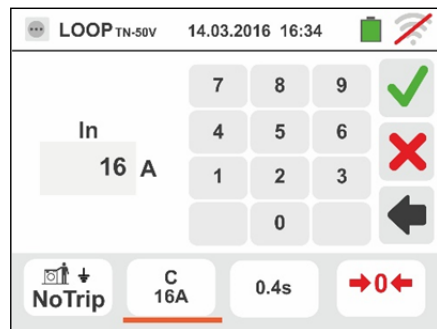

5. Move the slide bar reference by selecting the protection tripping time between the options: **0.1s**, **0.2s**, **0.4s**, **1s**, **5s** (all countries except AUS/NZ), **0.4s**, **5s** (Fuse protection for AUS/NZ) and **0.4s** (MCB protection for AUS/NZ)

Confirm the choice by going back to the initial measurement screen

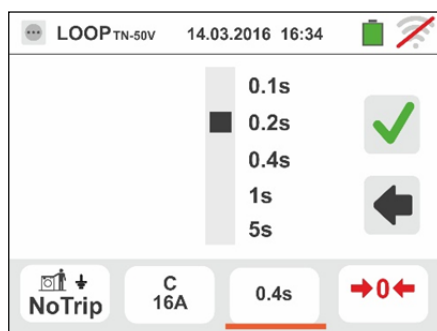

6. If possible, disconnect all loads connected downstream of the measured point, as the impedance of these users could distort the test results. Perform the preliminary calibration of the test leads as described in § 6.4.2 Connect the alligator clips or the remote lead to the electrical mains according to Fig. 18, Fig. 19, Fig. 20 and Fig. 22 in the farthest possible point respect the protection on test.

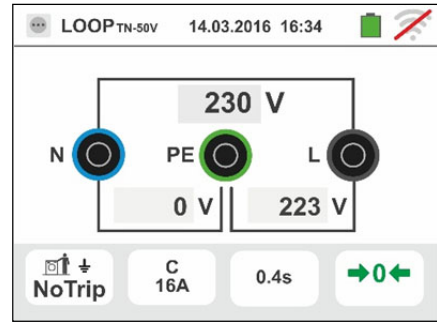

Note the presence of the correct voltage values between L-N and L-PE corresponding to the selections carried out in the initial phase (see § 5.1.4) as shown in the screen to the side.

7. Press the **GO/STOP** key for few seconds or the **START** key on the remote lead. During this whole stage, do not disconnect the measuring leads of the instrument from the system under test.

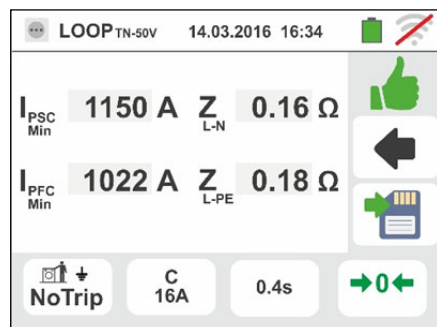

In case of positive result ( $Z_{L-PE}$  **LOWER** or **EQUAL** to **limit impedance relative to protection device within the specified time** – see § 13.7), the screen to the side is displayed by the instrument. Press the **SAVE** button

or touch the  icon to save the measurement (see § 7.1).

8. ( $Z_{L-PE}$  **HIGHER** to **limit impedance relative to protection device within the specified time** – see § 13.7), the screen to the side is displayed by the

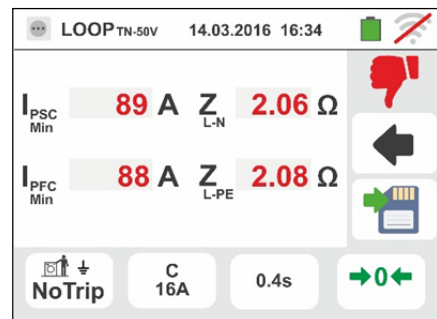

instrument. Press the **SAVE** button or touch the  icon to save the measurement (see § 7.1).

9. If the electrical Noise between N and PE conductors is so high that it could compromise the result accuracy, the symbol  is displayed. It's recommended to switch off all the electrical loads and re-attempt the measurement

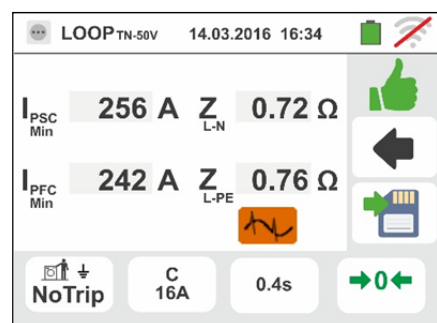



6.4.10. **Verify of protection against indirect contacts (No Trip test – UK Country)**

1. Select the “UK” country (see § 5.1.2) , options "TN", “25 or 50V”, “50Hz or 60Hz” and the reference voltage in the general settings of the instrument (see § 5.1.4).

Touch the icon. The screen to the side appears on the display.

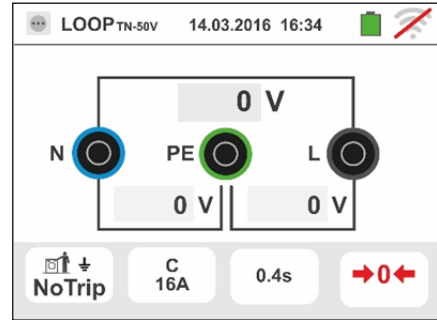

Touch the lower icon. The following screen appears on the display:

2. Move the left slide bar reference by selecting the icon to execute the measurement.

Move the central slide bar reference by selecting the "NoTrip" option. The right slide bar reference is automatically set in position .

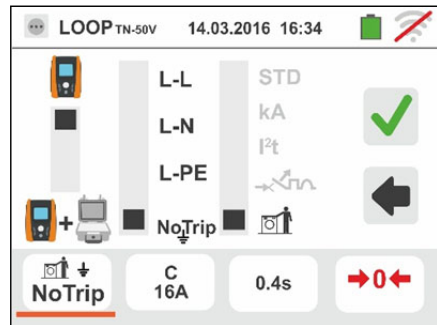

Confirm the choice by going back to the initial measurement screen.

3. Move the slide bar reference by selecting the type of protection (Fuse of type **BS88-2**, **BS88-3**, **BS3036**, **BS1362**, magnetothermal MCB in curve **B**, **C**, **D** or nominal trip out currents **10**, **30**, **100**, **300**, **500**, **650**, **1000mA** for **RCD** protection devices.

Touch the “In” field. The following screen appears on the display

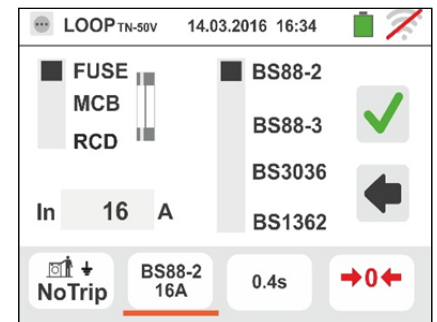

4. Touch the icon to zero the value in the In field and use the virtual keyboard to set the value of the nominal current of the protection within the values allowed by the instrument (see § 6.4.5)

Confirm the choice by going back to the previous screen.

Touch the icon in the lower right corner to set the tripping time of the protection. The following screen appears on the display

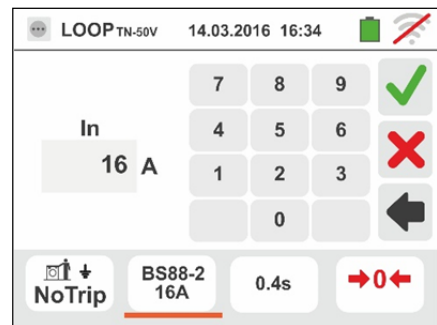

5. Move the slide bar reference by selecting the protection tripping time between the options: **0.4s**, **5s**

Confirm the choice by going back to the initial measurement screen

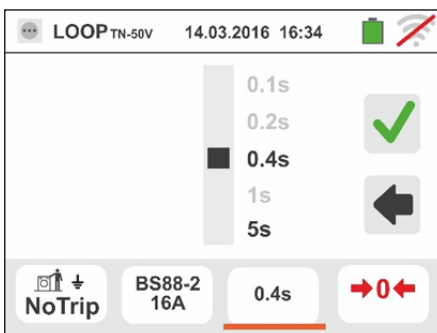



6. If possible, disconnect all loads connected downstream of the measured point, as the impedance of these users could distort the test results. Perform the preliminary calibration of the test leads as described in § 6.4.2 Connect the alligator clips or the remote lead to the electrical mains according to Fig. 18, Fig. 19, Fig. 20 and Fig. 22 in the farthest possible point respect the protection on test.

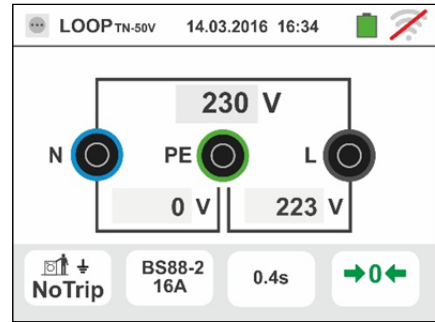

Note the presence of the correct voltage values between L-N and L-PE corresponding to the selections carried out in the initial phase (see § 5.1.4) as shown in the screen to the side.

7. Press the **GO/STOP** key for few seconds or the **START** key on the remote lead. During this whole stage, do not disconnect the measuring leads of the instrument from the system under test.

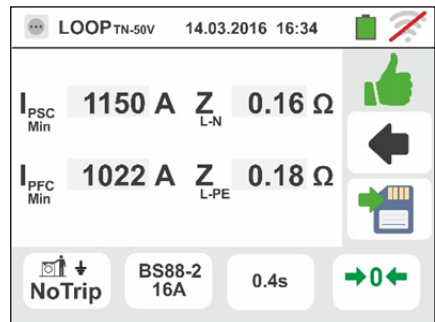



In case of positive result ( $Z_{L-PE}$  or  $Z_{L-N}$  **LOWER** or **EQUAL** to limit impedance relative to protection device within the specified time – see § 13.7), the screen to the side is displayed by the instrument. Press

the **SAVE** button or touch the  icon to save the measurement (see § 7.1).

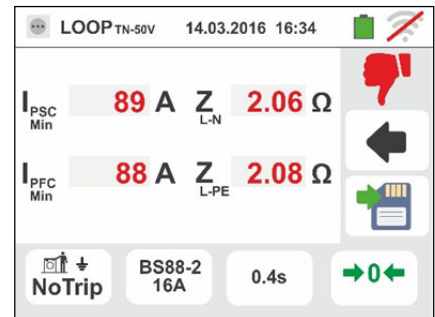
8. ( $Z_{L-PE}$  or  $Z_{L-N}$  **HIGHER** to limit impedance relative to protection device within the specified time – see § 13.7), the screen to the side is displayed by the



instrument. Press the **SAVE** button or touch the  icon to save the measurement (see § 7.1).

9. If the electrical Noise between N and PE conductors is so high that it could compromise the result accuracy, the symbol  is displayed. It's recommended to switch off all the electrical loads and re-attempt the measurement

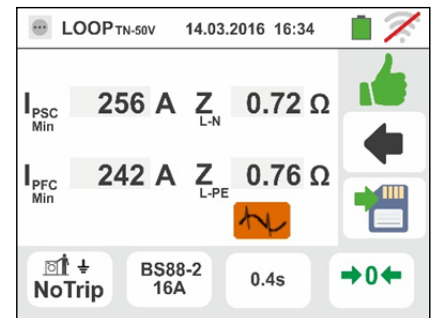

### 6.4.11. Verify of protection against indirect contacts (IT systems)

1. Select the options "IT", "25 or 50V", "50Hz or 60Hz" and the reference voltage in the general settings of the instrument (see § 5.1.4).

Touch the icon. The screen to the side appears on the display.

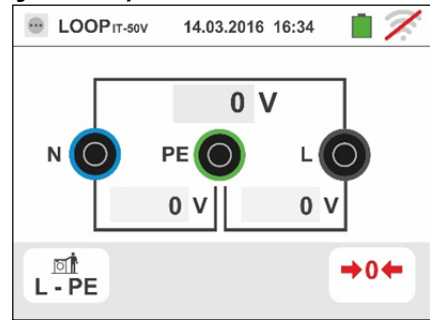

Touch the lower icon. The following screen appears on the display:

2. Move the left slide bar reference by selecting the icon to execute the measurement.

Move the central slide bar reference by selecting the "L-PE" option. The right slide bar reference is automatically set in position .

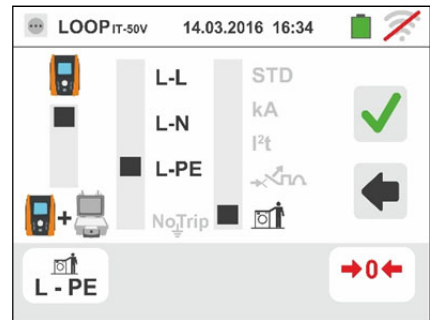

Confirm the choice by going back to the initial measurement screen.

3. If possible, disconnect all loads connected downstream of the measured point, as the impedance of these users could distort the test results. Perform the preliminary calibration of the test leads as described in § 6.4.2 Connect the alligator clips or the remote lead to the electrical mains according to Fig. 23. Note the presence of the correct voltage values between L-L and L-PE corresponding to the selections carried out in the initial phase (see § 5.1.4) and a possible N-PE voltage due to the IT system as shown in the screen to the side.

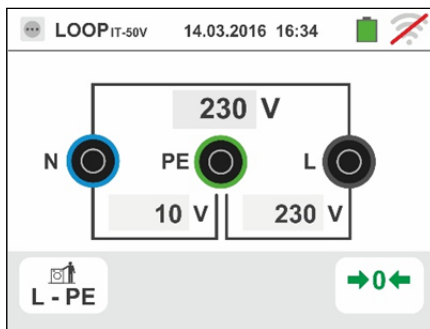

4. Press the **GO/STOP** key for few seconds or the **START** key on the remote lead. During this whole stage, do not disconnect the measuring leads of the instrument from the system under test.

In case of positive result (contact voltage at the point <50V or <25V), the screen to the side is displayed by the instrument, which contains the value of the first fault current measured, expressed in **mA** (see § 13.9). **With  $I_{sc} < 30\text{mA}$  the  $U_t$  value is not displayed**

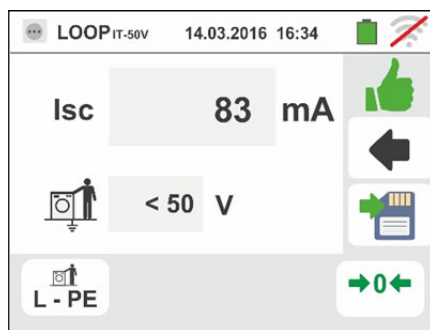

Press the **SAVE** button or touch the icon to save the measurement (see § 7.1).

5. In case of negative result (contact voltage at the point >50V or >25V), the screen to the side is displayed by the instrument.

Note the presence of the measurement result of the contact voltage highlighted in red.

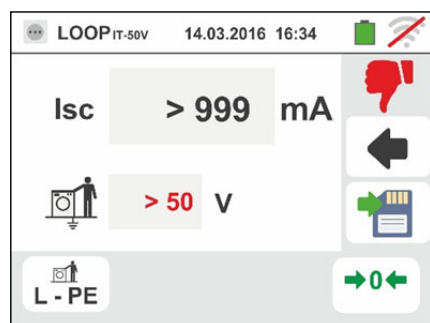

Press the **SAVE** button or touch the icon to save the measurement (see § 7.1).

### 6.4.12. Verify of protection against indirect contacts (TT systems)

1. Select the options "TT", "25 or 50V", "50Hz or 60Hz" and the reference voltage in the general settings of the instrument (see § 5.1.4).

Touch the  icon. The screen to the side appears on the display.

Touch the lower icon on the left. The following screen appears on the display:

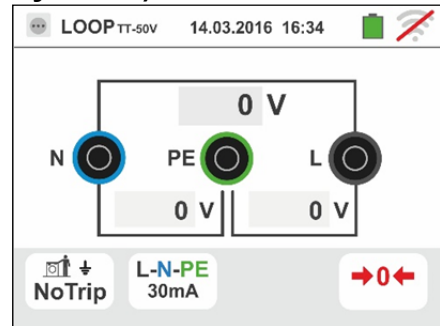

2. Move the left slide bar reference by selecting the  icon to execute the measurement.

Move the middle slide bar reference by selecting the "NoTrip 

Confirm the choice by going back to the initial measurement screen.

Touch the lower icon on the right. The following screen appears on the display:

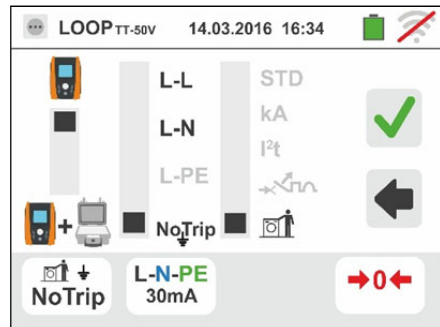

3. Move the left slide bar reference by selecting the RCD tripping time between the values: **6, 10, 30, 100, 300, 500, 650, 1000mA**

Move the right slide bar reference by selecting the connection type between the options: **L-N-PE** (presence of neutral conductor) or **L-X-PE** (absence of neutral conductor)

Confirm the choices by going back to the initial measurement screen.

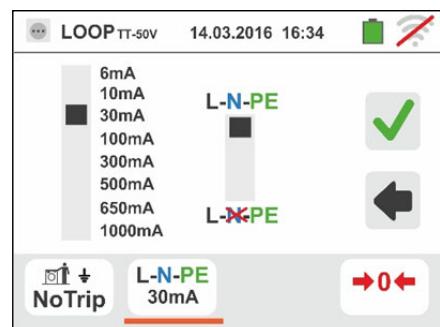

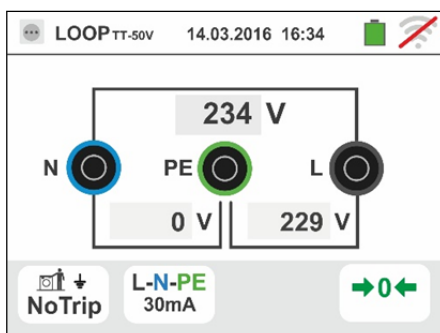

4. If possible, disconnect all loads connected downstream of the measured point, as the impedance of these users could distort the test results. Perform the preliminary calibration of the test leads as described in § 6.4.2 Connect the shuko plug, the alligator clips or the remote lead to the electrical mains according to Fig. 12, Fig. 13 and Fig. 14. The connection point of the instrument (near or far from the protection) is usually irrelevant to the test as the resistance of the wires is negligible compared to the value of earth resistance. Note the presence of the correct voltage values between L-L and L-PE corresponding to the selections carried out in the initial phase (see § 5.1.4) as shown in the screen to the side.

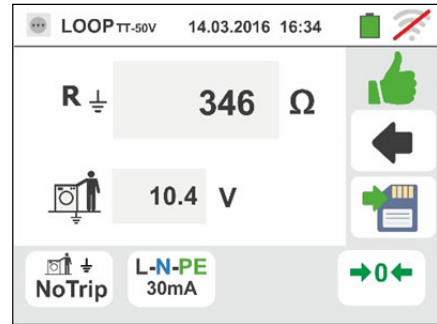

5. Press the **GO/STOP** key for few seconds or the **START** key on the remote lead. During this whole stage, do not disconnect the measuring leads of the instrument from the system under test.

In case of positive result (overall earth resistance lower than the ratio between limit contact voltage and RCD tripping current), the screen to the side is displayed by the instrument, which contains the contact voltage value in the secondary display.



Press the **SAVE** button or touch the  icon to save the measurement (see § 7.1).

6. In case of negative result (overall earth resistance higher than the ratio between limit contact voltage and RCD tripping current), the screen to the side is displayed by the instrument.

Note the presence of the measurement result of the contact voltage highlighted in red.

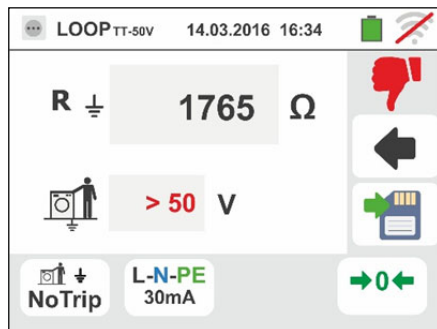

Press the **SAVE** button or touch the  icon to save the measurement (see § 7.1).

**6.4.13. Impedance measurement by means of the accessory IMP57**

Impedance measurements performed with the optional accessory IMP57 involve its connection to the Master unit via optical connector through the optical cable/RS-232 C2001 supplied with same accessory.

The IMP57 must be directly powered by the mains on which measurements are performed. For detailed information, please refer to the user manual of the accessory IMP57.

Please find below the procedure for the measurement of **STD L-L impedance in TN systems**. The same procedures can be applied to any other case considering what is reported in previous chapters.

1. Select the options "TN", "25 or 50V", "50Hz or 60Hz" and the reference voltage in the general settings of the instrument (see § 5.1.4).

Touch the  icon. The screen to the side appears on the display.

Touch the lower icon on the left. The following screen appears on the display:

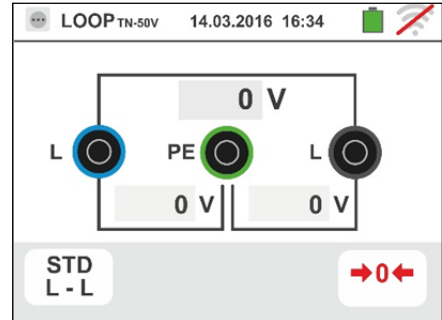

2. Move the left slide bar reference by selecting the  icon to execute the measurement with the accessory IMP57.

Move the central slide bar reference by selecting the "L-L" option.

Move the right slide bar reference by selecting the "STD" option.

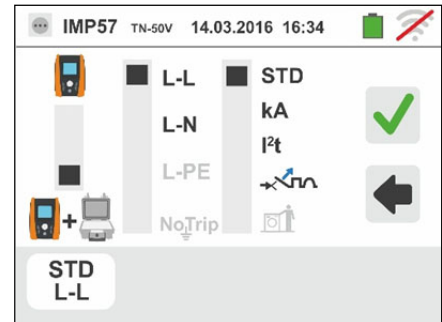

Confirm the choice by going back to the following initial measurement screen.

3. The  symbol on the display indicates that the accessory IMP57 is not connected to the instrument or not powered directly by the mains.

Connect the IMP57 to the instrument via the cable C2001 and to the powered system via the input terminals **C1**, **C2** and **P1**, **P2** placed on it (see the IMP57 user manual). The following screen appears on the display:

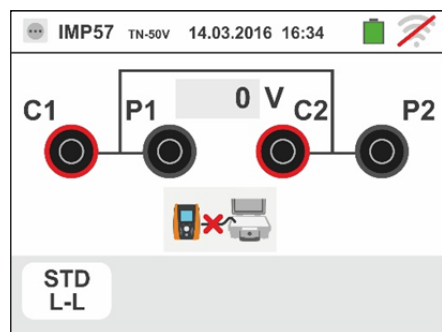

4. The  symbol indicates the correct connection and recognition of the IMP57 by the instrument. Check the green STATUS LED lighting on the IMP57.

The value of the voltage between the measurement points is shown in the upper part of the display.

Press the **GO/STOP** key for few seconds on the instrument to start the test. The following screen is shown on the display (in case of L-L measurement in STD mode)

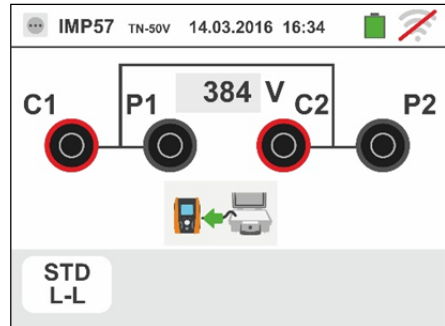

5. The standard (STD) short-circuit current is shown in the upper part of the display.

The P-P Loop impedance values, in addition to its resistive and reactive components, are shown in the central part of the display, expressed in **mΩ**.

Press the **SAVE** button or touch the  icon to save the measurement (see § 7.1).

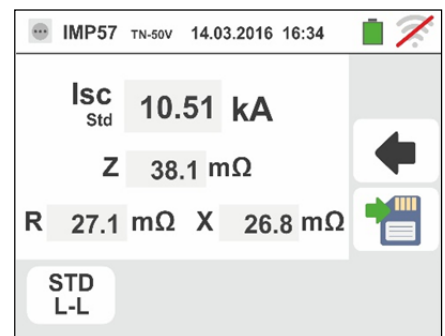



### 6.4.14. Anomalous situations

1. If the instrument detects an L-N or L-PE voltage higher than the maximum limit (265V), it does not carry out the test and displays a screen like the one to the side. Check the connection of measuring cables.

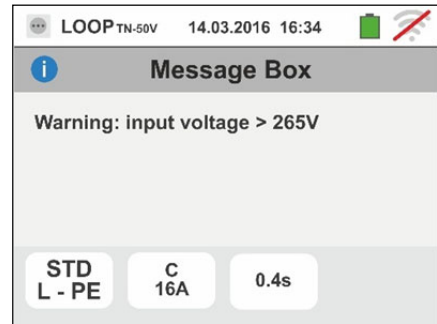

2. If the instrument detects an L-N or L-PE voltage lower than the minimum limit (100V), it does not carry out the test and displays a screen like the one to the side. Check that the system being tested is supplied.

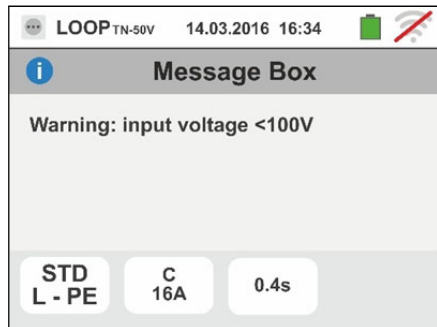

3. If the instrument detects the absence of the signal to terminal B1 (phase conductor), it provides the warning screen shown to the side and blocks the execution of the tests.

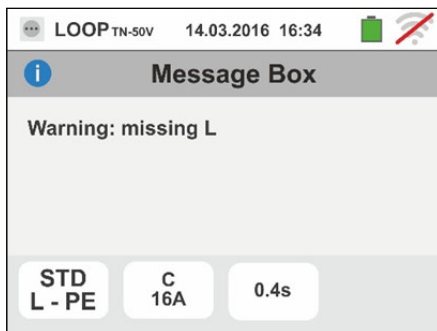

4. If the instrument detects the absence of the signal to terminal B4 (neutral conductor), it provides the warning screen shown to the side and blocks the execution of the tests.

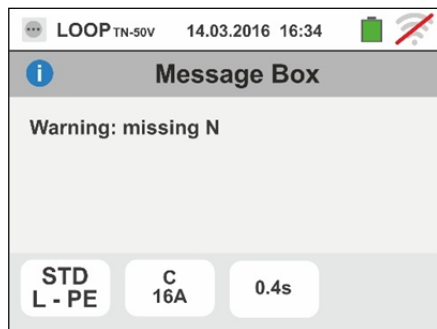

5. If the instrument detects the absence of the signal to terminal B3 (PE conductor), it provides the warning screen shown to the side and blocks the execution of the tests.

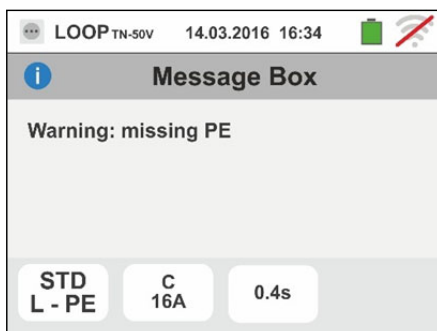

6. If the instrument detects that the phase and neutral leads are inverted, it does not carry out the test and a screen similar to the one reported to the side is displayed. Rotate the shuko plug or check the connection of measuring cables.

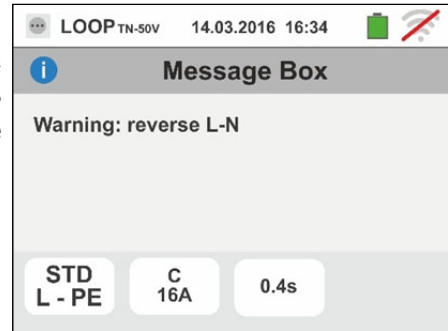

7. If the instrument detects that the phase and PE leads are inverted, it does not carry out the test and a screen similar to the one reported to the side is displayed. Check the connection of measuring cables.

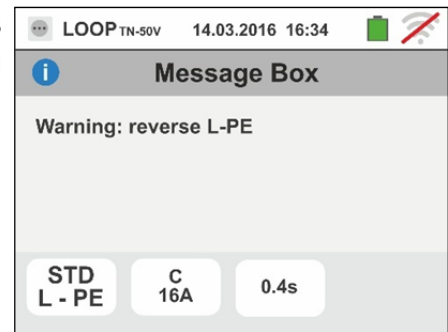

8. If the instrument detects a danger voltage on PE conductor, it does not carry out the test and displays a screen like the one to the side. This message can also appear in case of an insufficient pressure of the **GO/STOP** key

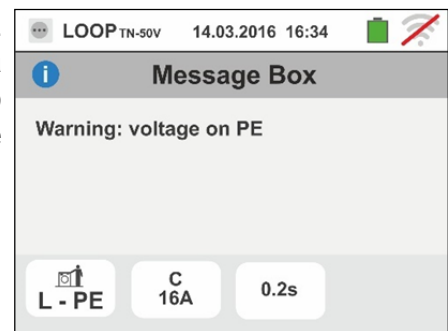

9. If the instrument detects a voltage  $V_{N-PE} > 50V$  (or  $> 25V$  depending on the selection), it does not carry out the test and displays a screen like the one to the side

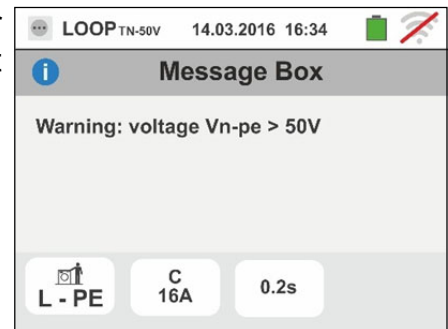

## 6.5. SEQ: PHASE SEQUENCE AND PHASE CONCORDANCE TEST

This function is performed in compliance with standards IEC/EN61557-7 and allows testing the phase sequence and concordance by direct contact with live parts (**not on cables with insulating sheath**). The following operating modes are available:

- 1T one lead measurement
- 2T two leads measurement.

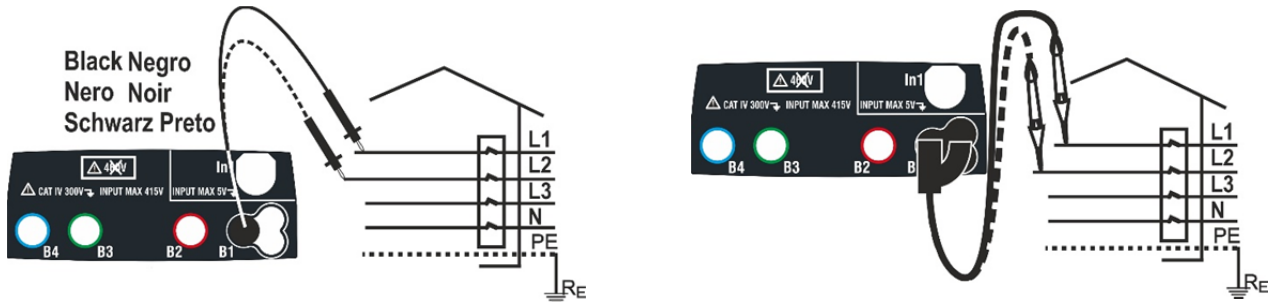

Fig. 24: Phase sequence check of 1T phases with terminal and remote lead

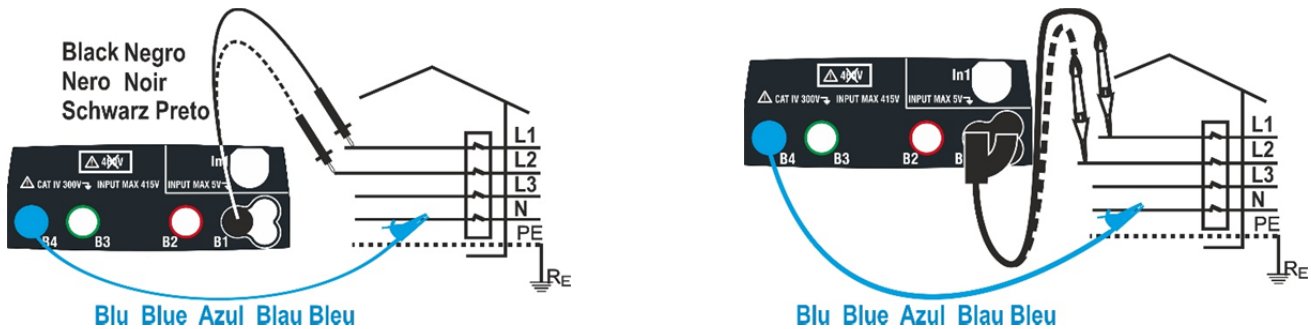

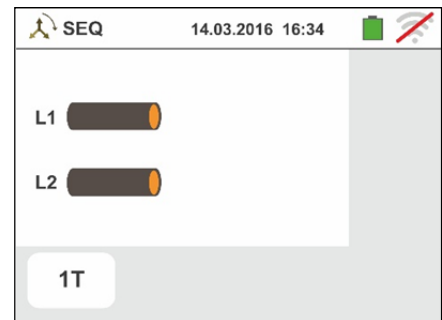

Fig. 25: Phase sequence check of 2T phases with terminal and remote lead

1. Touch the  icon. The screen to the side appears on the display.  
Touch the "1T" icon to set the measuring mode. The following screen appears on the display:



2. Move the slide bar reference in the position "1T" for the selection of the test with 1 terminal or in the position "2T" for the selection of the test with 2 terminals.

Confirm the choice by going back to the following initial measurement screen.

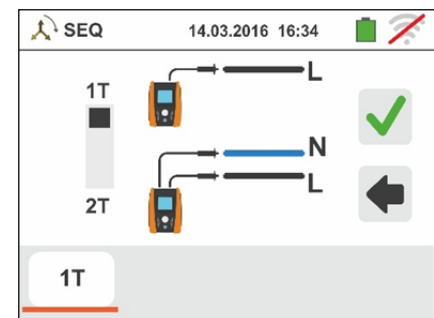

3. Insert the blue and black connectors of the single cables in the corresponding input terminals of the instrument B4, B1 (2T measurement). Insert in the free end of the cables the corresponding alligator clips or tips. It is also possible to use the remote lead by inserting its multipolar connector into the input lead B1. Connect the alligator clips, the tips or the remote lead to phase L1 and N according to Fig. 24 and Fig. 25.

4. Press the **GO/STOP** key on the instrument or the **START** key on the remote lead. The instrument will start the measurement. During this whole stage, do not disconnect the measuring leads of the instrument from the system under test.

The symbol for the tip on phase L1 and the hourglass indicating the status of pending recognition of a voltage higher than the maximum allowed.

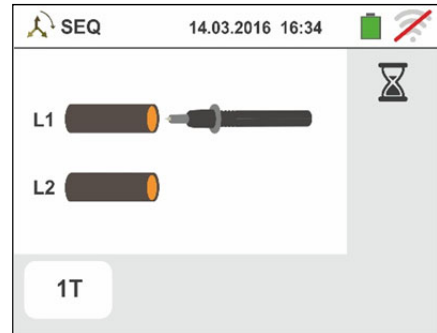

5. Once the correct voltage recognized, the ⚡ symbol is shown on the display. The instrument gives out a long sound until input voltage is present.

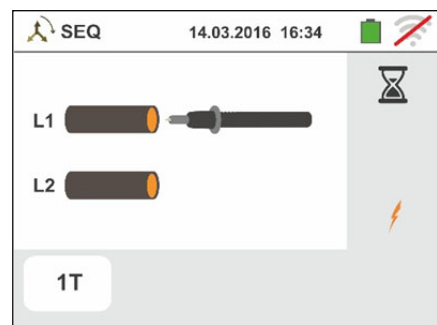

6. At the end of phase L1 acquisition, the instrument is in standby waiting for the signal on phase L2 and showing the symbol of "disconnected tip" as shown in the screen to the side.

Under these conditions, connect the alligator clips, the tips or the remote lead to phase L2 and N in accordance with Fig. 24 and Fig. 25.

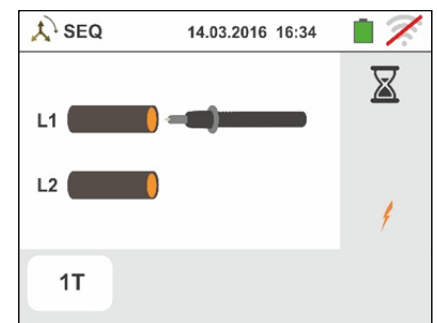

7. The symbol for the tip on phase L2 and the hourglass indicating the status of pending recognition of a voltage higher than the maximum allowed.

Once the correct voltage recognized, the ⚡ symbol is shown on the display.

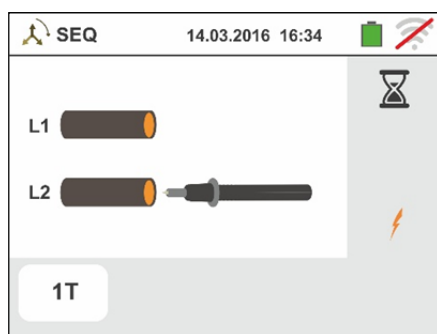

8. At the end of the test, if the detected phase sequence is correct, the instrument displays a screen like the one shown to the side (result "1-2-3").

Press the **SAVE** button or touch the  icon to save the measurement (see § 7.1).



9. At the end of the test, if the two detected voltages are in phase (**phase concordance between two distinct three-phase systems**), the instrument displays a screen like the one to the side (result "1-1-").

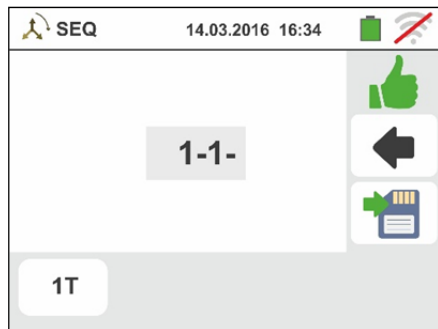

- 10 At the end of the test, if the detected phase sequence is not correct, the instrument displays a screen like the one shown to the side (result "2-1-3").

Press the **SAVE** button or touch the  icon to save the measurement (see § 7.1).



### 6.5.1. Anomalous situations

1. If between the test start and the acquisition of the first voltage or between the acquisition of the first and second voltage, a time longer than around 10s has elapsed, the instrument displays a screen like the one to the side.

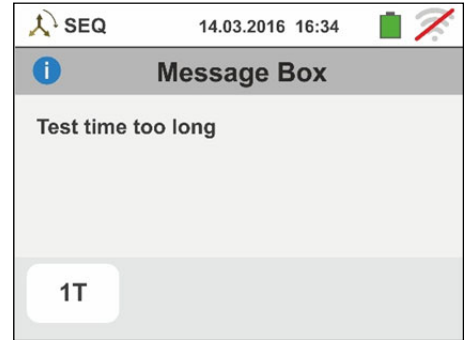

2. If the instrument detects an input voltage higher than the maximum limit, it will display a screen like the one to the side.

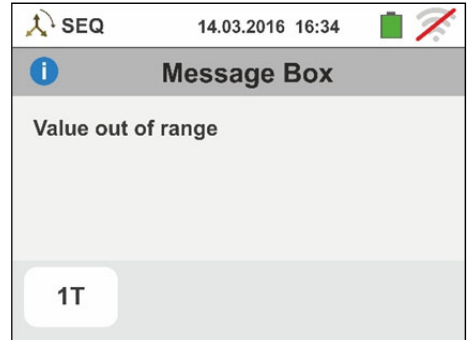

3. If the instrument detects an input voltage frequency exceeding the allowed full scale, it will display a screen like the one to the side.

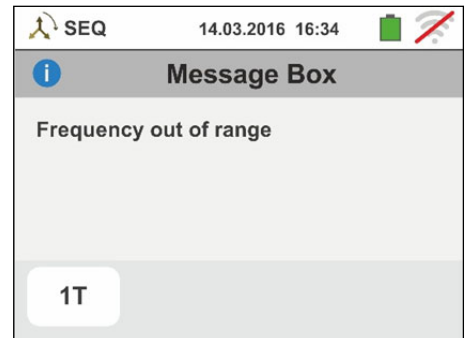



## 6.6. LEAKAGE: LEAKAGE CURRENT MEASUREMENT

Using an external clamp, this function allows measuring the leakage current (by means of the optional accessory HT96U).

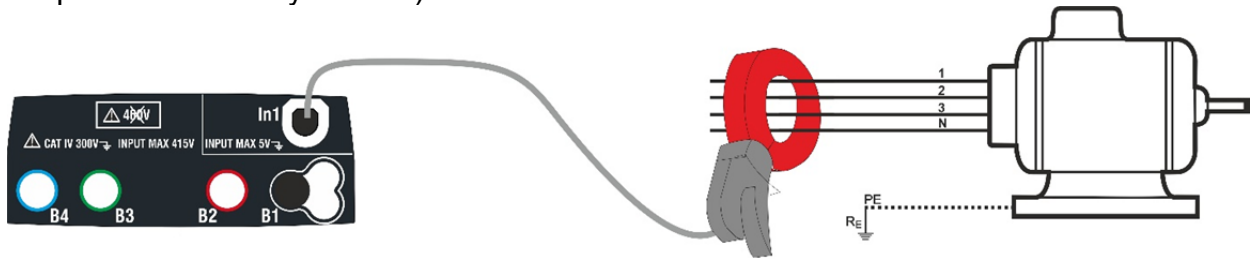

Fig. 26: Indirect measurement of leakage current in three-phase systems

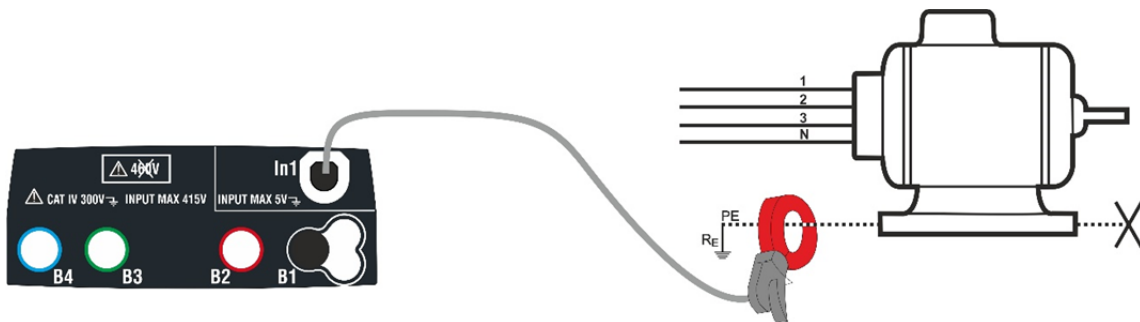

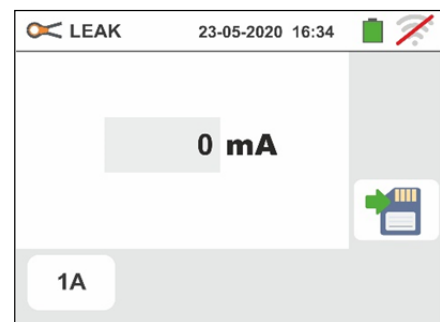



Fig. 27: Direct measurement of leakage current in three-phase systems

1. Touch the  icon. The screen to the side appears on the display.

Touch the icon in the lower left corner to set the full scale of the clamp used. The following screen appears on the display:



2. Touch the  icon to zero the value in the In field and use the virtual keyboard to set the full-scale value of the clamp used ((values of 1A, 100A, 1000A for the HT96U clamp).

Confirm the choice by going back to the previous screen. With FS = 1A, the instrument automatically carries out the measurement in **mA**.



3. Insert the external clamp into instrument input In1.
4. For indirect measurements of leakage current, connect the external clamp according to Fig. 26. For direct measurements of leakage current, connect the clamp according to Fig. 27 and disconnect possible additional earth connections that could influence the test results.



### CAUTION

Possible additional earth connections could influence the measured value. In case of real difficulty in removing them, we recommend performing the measurement in an indirect way.

5. The value of the measured leakage current appears in real time on the display as shown in the screen to the side.

Press the **SAVE** button or touch the  icon to save the measurement (see § 7.1).

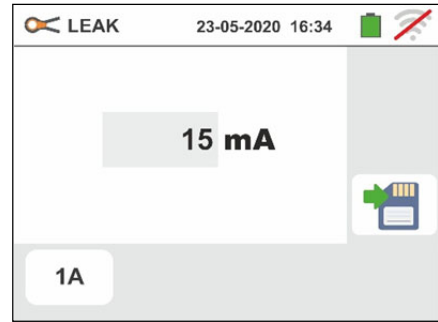

## 6.7. EARTH: MEASUREMENT OF EARTH RESISTANCE

The instrument allows performing the measurement of earth resistance of an installation in the following ways:

- Measurement of earth resistance with 3-wire or 2-wire voltammetric method
- Measurement of ground resistivity ( $\rho$ ) with Wenner 4-wire method
- Measurement of resistance of individual rods without disconnecting them by means of the optional clamp T2100

### 6.7.1. 3-wire or 2-wire earth measurement and 4-wire ground resistivity

The measurement is carried out in compliance with standards IEC/EN61557-5.

#### CAUTION



- The instrument can be used for measurements on installations with overvoltage category CAT III 240V to earth with a maximum voltage of 415V between inputs. Do not connect the instrument to installations with voltages exceeding the limits indicated in this manual. Exceeding these limits could result in electrical shocks to the user and damage to the instrument.
- Always connect the measuring cables to the instrument and to the alligator clips with the accessories disconnected from the system.
- We recommend holding the alligator clip respecting the safety area created by the hand protection (see § 4.2).
- If the length of the cables supplied is not suitable for the installation under test, you can create your own extensions following the indications in § 0.

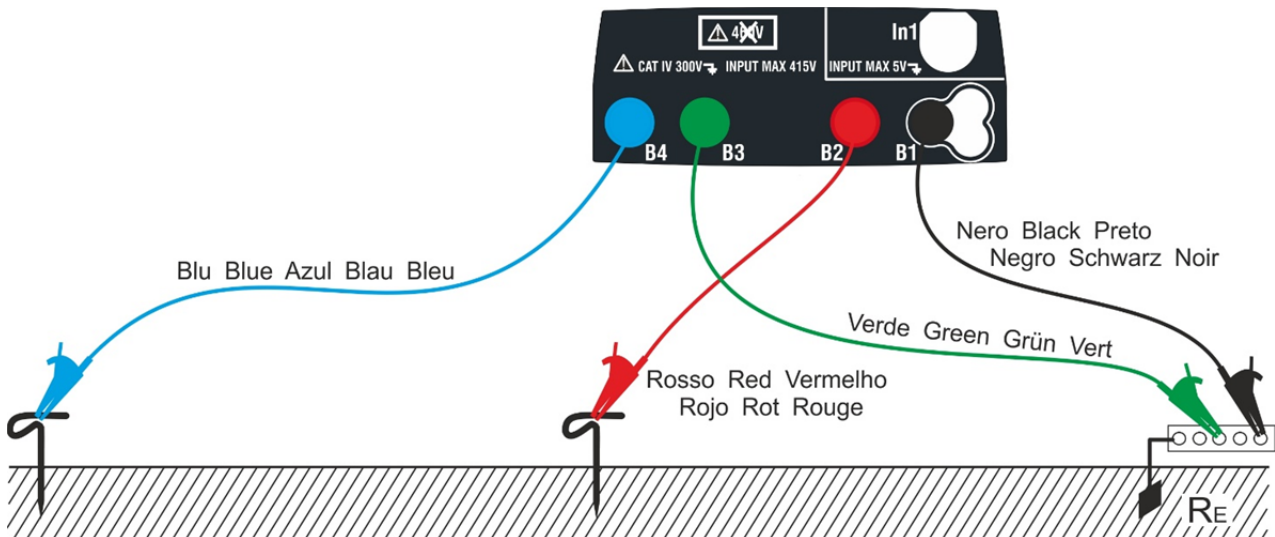

Fig. 28: Three-wire earth resistance measurement

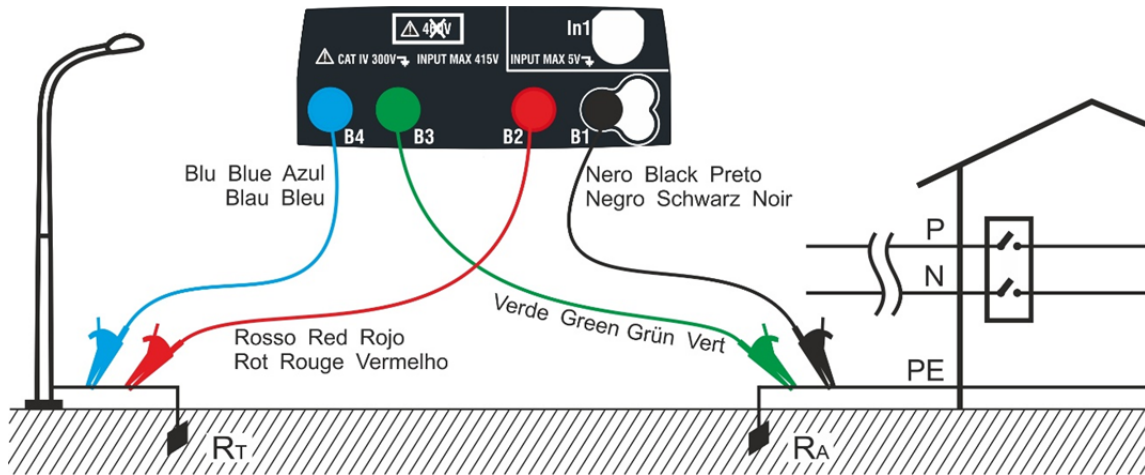

Fig. 29: Two-wire earth resistance measurement using an auxiliary rod

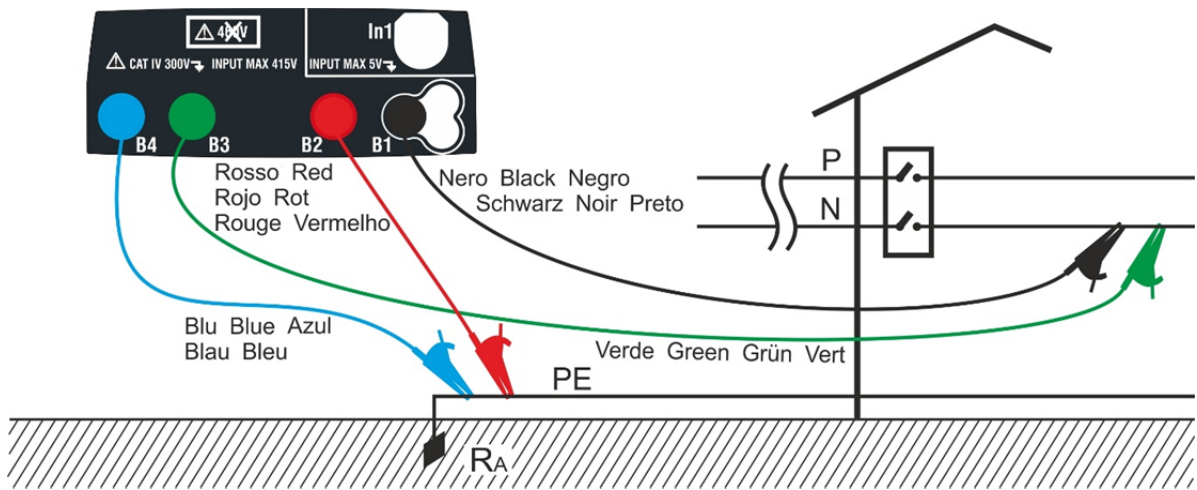

Fig. 30: Two-wire earth resistance measurement from the panel board

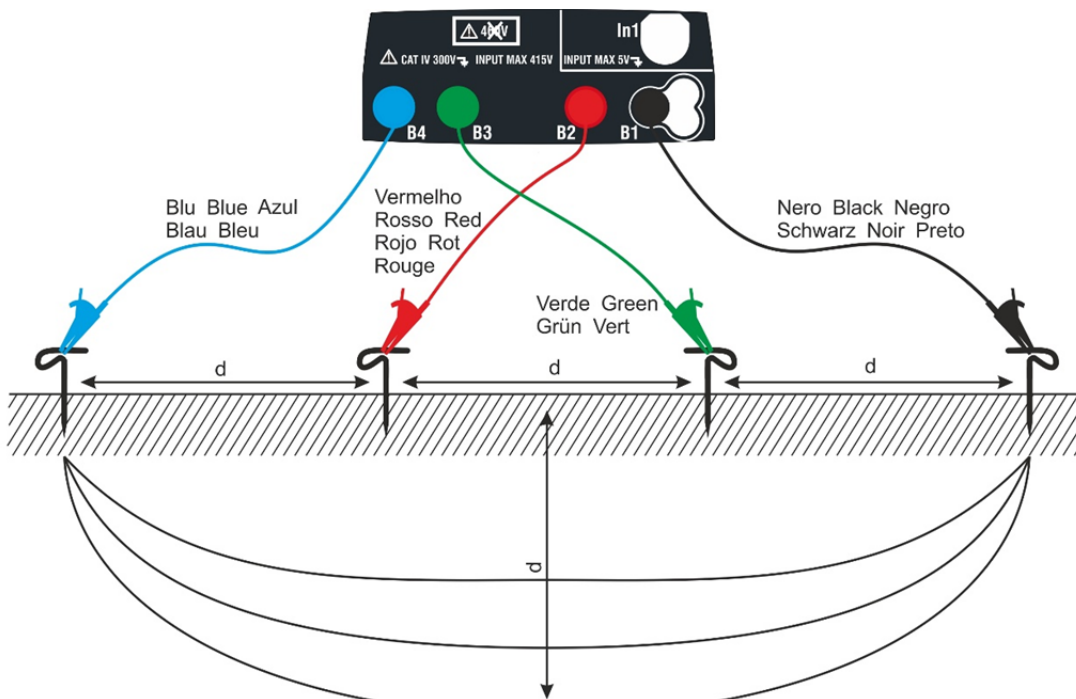

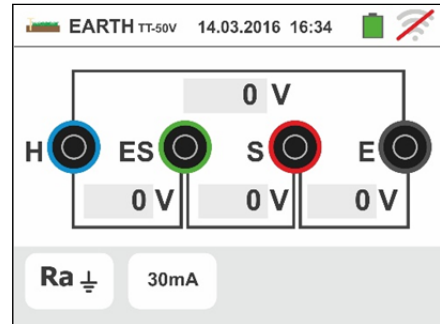



Fig. 31: Ground resistivity measurement

1. Select the options “TN, TT or “IT”, “25 or 50V”, “50Hz or 60Hz” and the reference voltage in the general settings

of the instrument (see § 5.1.4). Touch the  icon. The screen to the side (**TT and IT systems**) is shown on the display. The instrument automatically carries out the test in presence of voltage between the inputs (shown on the display) and blocks the test in case of voltage higher than 10V

Touch the first icon in the lower left corner to set the measuring mode. The following screen appears on the display:



2. Move the slide bar reference in the position "**Ra**" for the selection of the earth measurement with voltammetric method, in the  position for the resistance measurement with use of optional clamp T2100 (see § 6.7.3) or in the "ρ" position for the measurement of ground resistivity. Confirm the choice by going back to the initial measurement screen.

Touch the second icon in the lower left corner to set the tripping current of the differential switch (**TT and IT systems**). The following screen appears on the display:

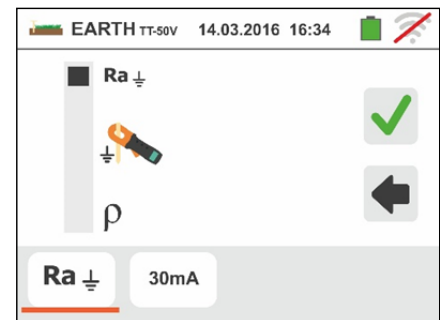

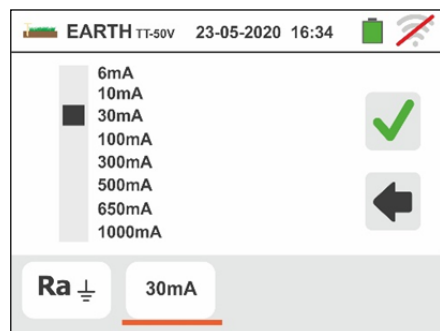

3. Move the slide bar reference in the position corresponding to the value of the tripping current of the RCD differential switch as shown in the screen to the side. On the basis of this selection and the value of contact voltage (25V or 50V), the instrument performs the calculation of the limit value of earth resistance (see § 13.12) that will compare with the measured value in order to provide the final positive or negative result of the measurement.

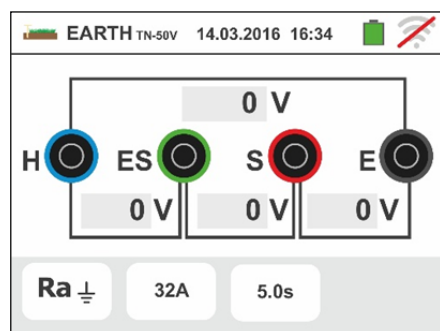

4. For **TN systems**, the instrument shows the initial screen as in the figure to the side.

Touch the central icon to set the rated current of the RCD. The following screen appears on the display:



5. Touch the  icon to zero the value in the "A" field and use the virtual keyboard to set the value of fault current (declared by the Energy distribution board) between **1A** and **9999A**. Confirm the choice by going back to the initial measurement screen.

Touch the icon in the lower right corner to set the tripping time of the RCD. The following screen appears on the display:

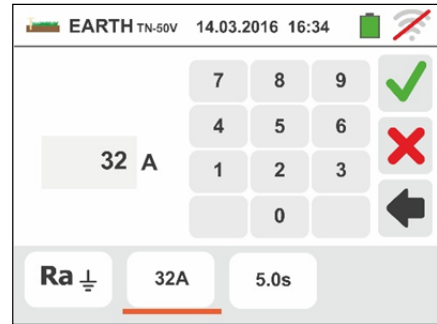

6. Touch the  icon to zero the value in the "s" field and use the virtual keyboard to set the value of the time for fault elimination **t** (declared by the Energy distribution board) between **0.04s** and **10s**. On the basis of previous selections, the instrument performs the calculation of the maximum limit of earth resistance according to the value of maximum allowable contact voltage (see § 13.12) that will compare with the measured value in order to provide the final positive or negative result of the measurement. Confirm the choice by going back to the initial measurement screen.

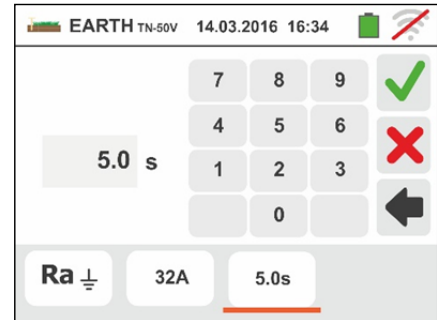

7. For **resistivity measurement**, the instrument shows the initial screen as in the figure to the side.

Touch the icon to the right to set the measurement unit and the distance between the test probes. The following screen appears on the display:

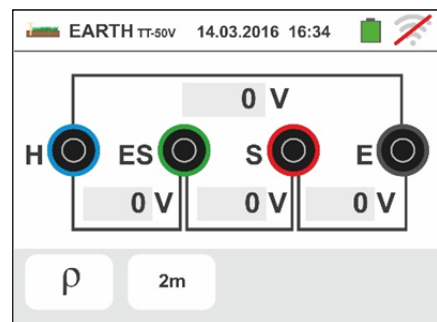

8. Move the slide bar reference on the left to select the measurement unit of the distance between the options: **m** (meters) or **ft** (feet).

Move the slide bar reference on the right to select the distance "d" between the measuring probes choosing between **1m ÷ 10m** (**3ft ÷ 30ft**).

Confirm the choices by going back to the initial measurement screen.

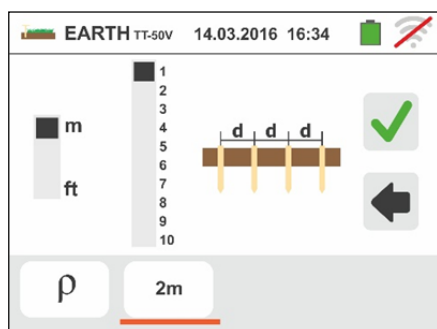

9. Connect the blue, red, green and black cables to the corresponding instrument input terminals H, S, ES, E, then add the alligator clips, if necessary.

10. Extend, if necessary, the blue and red measuring cables on a separate way by means of cables with proper section. Adding any extension does not require calibration and does not affect the measured earth resistance value.



- 11 Drive the auxiliary rods into the ground keeping to the distance instructions provided by the standards (see § 0).
- 12 Connect the alligator clips to the auxiliary rods and to the installation under test according to Fig. 28, Fig. 29, Fig. 30 or Fig. 31.

- 13 Press the **GO/STOP** key. During this whole stage, do not disconnect the measuring leads of the instrument from the system under test. The  symbol is shown on the display for the entire duration of the test.

For **earth resistance measurement in TT/IT systems**, in case of **positive** result, the screen to the side is displayed by the instrument. It contains the value of contact voltage in the secondary display, the value of contact resistance of the voltage probe ( $R_s$ ) and the value of contact resistance of the current probe ( $R_h$ ).

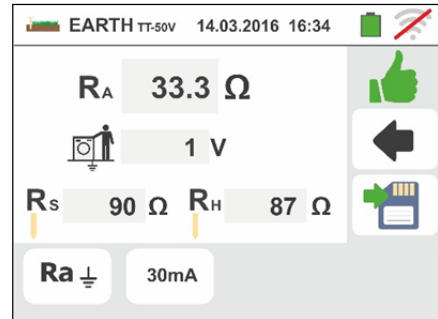

Press the **SAVE** button or touch the  icon to save the measurement (see § 7.1).

- 14 For **earth resistance measurement in TT systems**, in case of **negative** result (see § 13.7), the screen to the side is displayed by the instrument. It contains the value of contact voltage in the secondary display, the value of contact resistance of the voltage probe ( $R_s$ ) and the value of contact resistance of the current probe ( $R_h$ ).

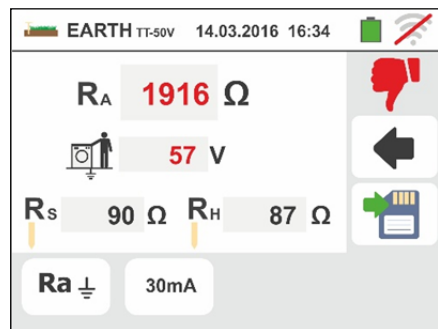

Note the presence of the measurement result highlighted in red.

Press the **SAVE** button or touch the  icon to save the measurement (see § 7.1).

- 15 For **earth resistance measurement in IT systems**, in case of **negative** result (see § 13.9), the screen to the side is displayed by the instrument. It contains the value of contact voltage in the secondary display, the value of contact resistance of the voltage probe ( $R_s$ ) and the value of contact resistance of the current probe ( $R_h$ ).

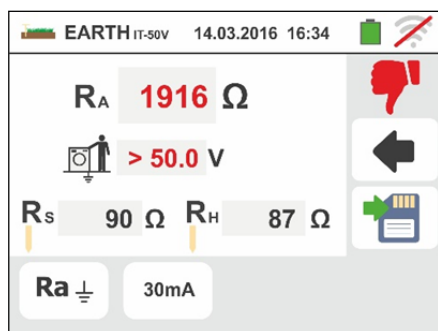

Note the presence of the measurement result highlighted in red.

Press the **SAVE** button or touch the  icon to save the measurement (see § 7.1)

- 16 For **earth resistance measurement in TN systems**, in case of **positive** result (see § 13.12), the screen to the side is displayed by the instrument. It contains the value of contact voltage in the secondary display, the value of contact resistance of the voltage probe ( $R_s$ ) and the value of contact resistance of the current probe ( $R_h$ ).



Press the **SAVE** button or touch the  icon to save the measurement (see § 7.1).

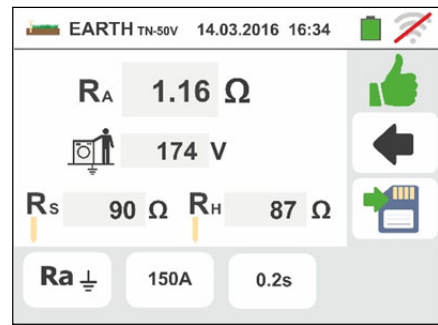

- 17 For **earth resistance measurement in TN systems**, in case of **negative** result (see § 13.12), the screen to the side is displayed by the instrument. It contains the value of contact voltage in the secondary display, the value of contact resistance of the voltage probe ( $R_s$ ) and the value of contact resistance of the current probe ( $R_h$ ).

Note the presence of the measurement result highlighted in red.



Press the **SAVE** button or touch the  icon to save the measurement (see § 7.1).

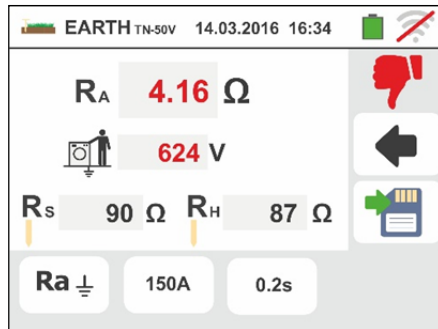

- 18 If the resistance value of  $R_s$  or  $R_h$  probes is  $> 100 * R_{measured}$  the instrument performs the measurement considering an accuracy of 10% of reading and marks the value in red in corrspondance of  $R_s$  and/or  $R_h$  the screen to the side is displayed

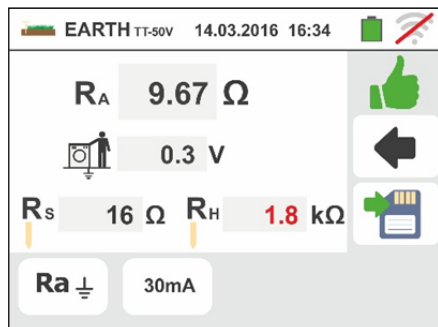

- 19 For **ground resistivity measurement**, the screen to the side is shown by the instrument. It contains the value of " $\rho$ " expressed in  $\Omega m$  and the " $V_n$ " value of the possible interfering voltage measured by the instrument during the test.



Press the **SAVE** button or touch the  icon to save the measurement (see § 7.1).

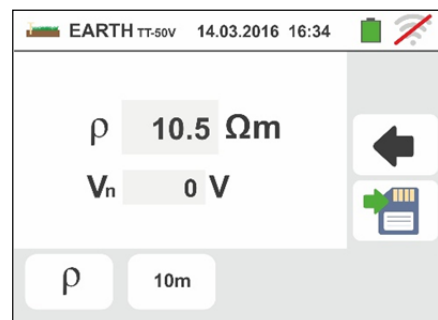



### 6.7.2. 3-wire or 2-wire earth measure – USA, Extra Europe and Germany countries

1. Select the “USA”, “Extra Europe” or “Germany” reference countries (see § 5.1.2). Select the options “TN”, “TT” (**measurement not available for USA country**) or “IT” (**measurement not available for USA country**), “25 or 50V”, “50Hz or 60Hz” and the reference voltage in the general settings of the

instrument (see § 5.1.4). Touch the  icon. The screen to the side (**TT and IT systems**) is shown on the display. The instrument automatically carries out the test in presence of voltage between the inputs (shown on the display) and blocks the test in case of voltage higher than 10V

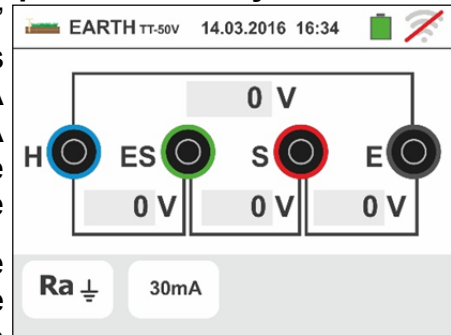
Touch the first icon in the lower left corner to set the measuring mode. The following screen appears on the display:



2. Move the slide bar reference in the position "**Ra**" for the selection of the earth measurement with voltammetric method, in the  position for the resistance measurement with use of optional clamp T2100 (see § 6.7.3) or in the "ρ" position for the measurement of ground resistivity. Confirm the choice by going back to the initial measurement screen.

Touch the second icon in the lower left corner to set the tripping current of the differential switch (**TT and IT systems**). The following screen appears on the display:

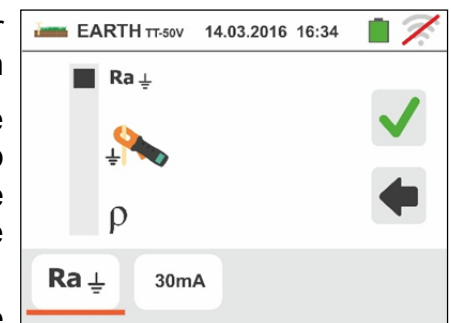

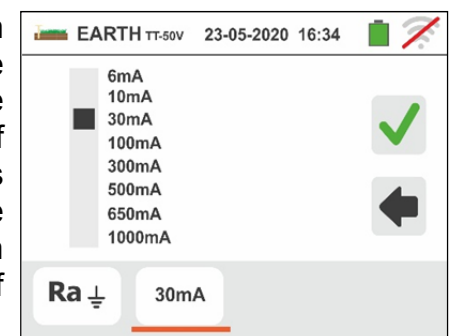

3. Move the slide bar reference in the position corresponding to the value of the tripping current of the RCD differential switch as shown in the screen to the side. On the basis of this selection and the value of contact voltage (25V or 50V), the instrument performs the calculation of the limit value of earth resistance (see § 13.12) that will compare with the measured value in order to provide the final positive or negative result of the measurement.

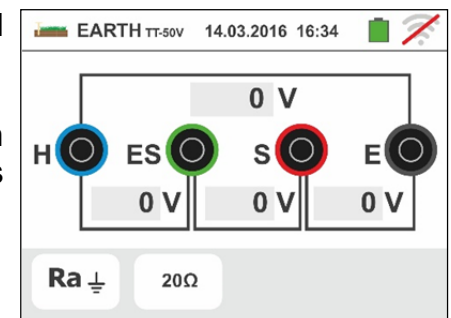

4. For **TN systems**, the instrument shows the initial screen as in the figure to the side.

Touch the second icon to set the limit value of the earth resistance which will be used by the instrument as reference. The following screen appears on the display:



5. Touch the  icon to zero the value in the "Ω" field and use the virtual keyboard to set the value of limit earth resistance between **1Ω** and **999Ω**. Confirm the choice by going back to the initial measurement screen.

Connect the instrument to the installation as indicated in the points 9, 10, 11 and 12 of the § 6.7.1)

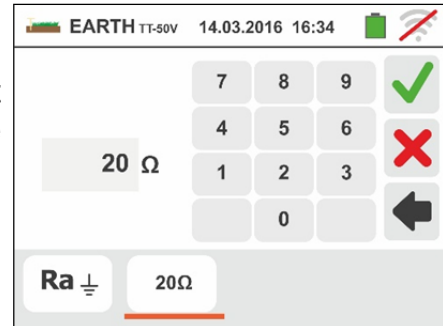

6. Press the **GO/STOP** key. During this whole stage, do not disconnect the measuring leads of the instrument from the system under test. The  symbol is shown on the display for the entire duration of the test.

For **earth resistance measurement in TT/IT systems**, in case of **positive** result (see § 13.7), the screen to the side is displayed by the instrument. It contains the value of contact voltage in the secondary display, the value of contact resistance of the voltage probe ( $R_s$ ) and the value of contact resistance of the current probe

( $R_h$ ). Press the **SAVE** button or touch the  icon to save the measurement (see § 7.1).

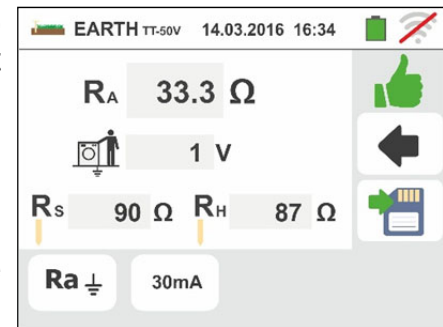

7. For **earth resistance measurement in TT systems**, in case of **negative** result (see § 13.7), the screen to the side is displayed by the instrument. It contains the value of contact voltage in the secondary display, the value of contact resistance of the voltage probe ( $R_s$ ) and the value of contact resistance of the current probe ( $R_h$ ).

Note the presence of the measurement result highlighted in red.

Press the **SAVE** button or touch the  icon to save the measurement (see § 7.1).

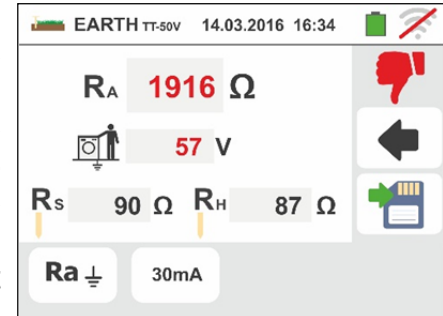

8. For **earth resistance measurement in IT systems**, in case of **negative** result (see § 13.9), the screen to the side is displayed by the instrument. It contains the value of contact voltage in the secondary display, the value of contact resistance of the voltage probe ( $R_s$ ) and the value of contact resistance of the current probe ( $R_h$ ).

Note the presence of the measurement result highlighted in red.

Press the **SAVE** button or touch the  icon to save the measurement (see § 7.1).

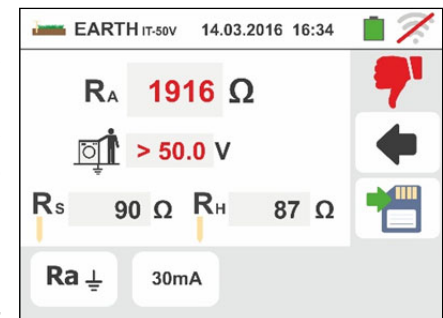

9. For **earth resistance measurement in TN systems**, in case of **positive** result (measured value LOWER than set limit value), the screen to the side is displayed by the instrument. It contains also the value of contact resistance of the voltage probe ( $R_s$ ) and the value of contact resistance of the current probe ( $R_h$ ).

Press the **SAVE** button or touch the  icon to save the measurement (see § 7.1).

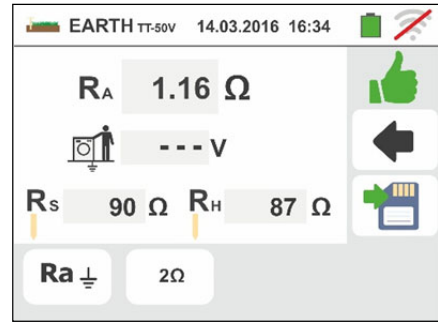

- 10 For **earth resistance measurement in TN systems**, in case of **negative** result (measured value HIGHER than set limit value), the screen to the side is displayed by the instrument. It contains also the value of contact resistance of the voltage probe ( $R_s$ ) and the value of contact resistance of the current probe ( $R_h$ ).

Note the presence of the measurement result highlighted in red.

Press the **SAVE** button or touch the  icon to save the measurement (see § 7.1).

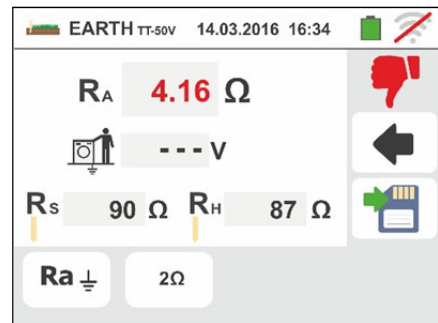

### 6.7.3. Earth measurement with optional clamp T2100

This measurement allows evaluating the partial resistances of the single earth rods of complex ring networks without disconnecting them and performs the calculation of the corresponding parallel resistance. Please refer to the user manual of clamp T2100 for specific details. The following measurement methods are available:

- Measurement of rod resistance with direct connection of clamp T2100 to the instrument.
- Measurement of rod resistance by means of clamp T2100 used independently and subsequent connection of the clamp to the instrument for data transfer.



#### CAUTION

The measurement carried out by clamp T2100 can be used to evaluate single rods resistance values within an earth installation without disconnecting the rods, **assuming they do not affect each other** (see Fig. 32).

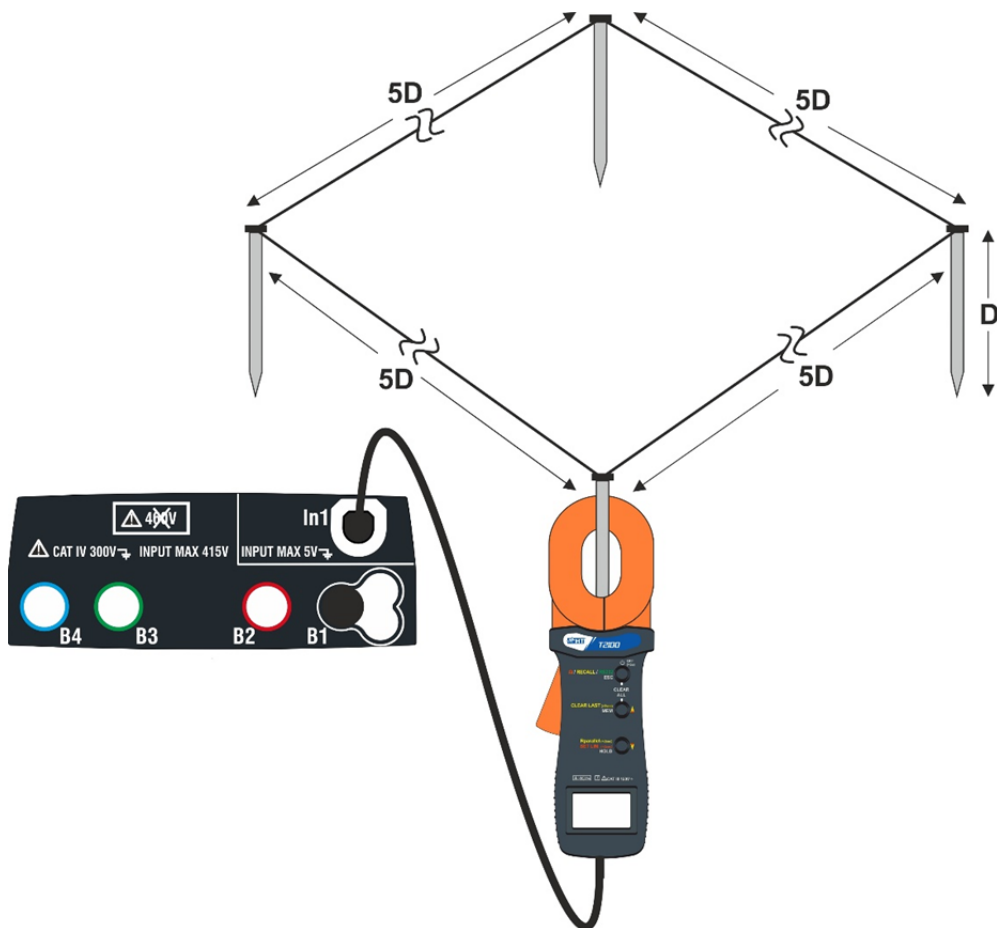
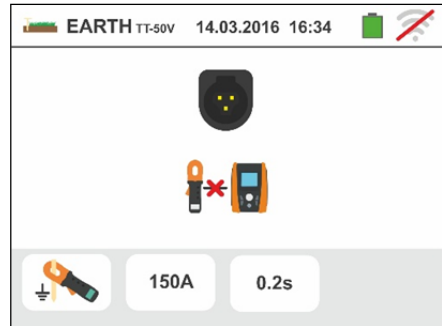

Fig. 32: Resistance measurement of single rods with clamp T2100



1. Select the options “TN, TT or “IT”, “25 or 50V”, “50Hz or 60Hz” and the reference voltage in the general settings of the instrument (see § 5.1.4). Touch the icon, touch the first icon in the lower left corner and set the measurement mode (see § 6.7.1 point 2). The following screen appears on the display. The icon indicates that the clamp T2100 is not connected to the instrument or is not in "RS232" mode. Configure the same settings on the protection parameters depending on the type of system (TT, TN or IT) (see § 6.7.1 points 3, 4, 5, 6 or see § 6.7.2 points 3, 4, 5)



2. Connect the clamp T2100 by inserting the connector into input **In1** of the instrument. Turn the clamp on and put it in "RS232" mode (see the user manual of the clamp). The  $\Omega$  symbol appears on the display of the clamp. **In these conditions, the instrument-clamp group is ready to perform the measurements.** The following screen is shown on the display by the instrument.

3. The meaning of the symbols is the following:

- → This icon indicate the correct serial connection of the clamp to the instrument
- → Touch this icon to zero all the values of the measured probes and the correspondent parallel resistance
- → Touch this icon to add a rod to the measurement. The "N" parameter increases by one unit.
- $R_A$  → indicates the calculation of the parallel of resistances for each measurement performed on each rod.
- → This indicates the value of contact voltage resulting from the measurement.
- $N$  → indicates the number of rods in the measure.
- $R$  → indicates the resistance value of the rod currently measured.
- → It allows downloading on the instrument the memory contents of clamp T2100 in order to obtain the final result of the measurement.

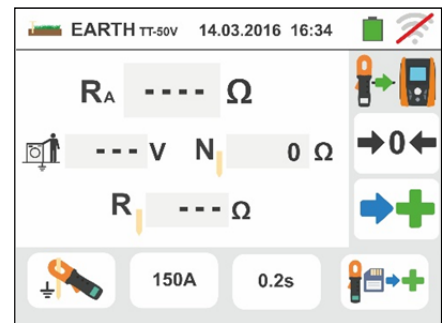





#### Rods resistance measurement with clamp T2100 connected to the instrument

4. Connect the clamp to the first rod of the earth network considered as shown in Fig. 32. Note the value of the resistance in the  $R$  field and press the icon to insert this value in the calculation of parallel resistance and increase the  $N$  parameter by one unit ( $N=1$ )

5. After the insertion of the value of the first rod it will be not possible to transfer the eventually measurements saved inside the T2100 by means the  key. Perform the same procedure for each rod of the network in question. At the end of the measurements, press the **GO/STOP** key on the instrument. The following screen appears on the display

6. The **R<sub>A</sub>** field shows the value of the resistances in parallel performed on each rod of the earth network considered. This value is compared with the maximum limit value calculated by the instrument according to the selections made on the parameters of the protections.

In case of positive result (see § 13.7 and § 13.12), the instrument shows the  symbol and it is also possible to scroll through the values of partial resistances by touching the keys  and 

Press the **SAVE** button or touch the  icon to save the measurement (see § 7.1).

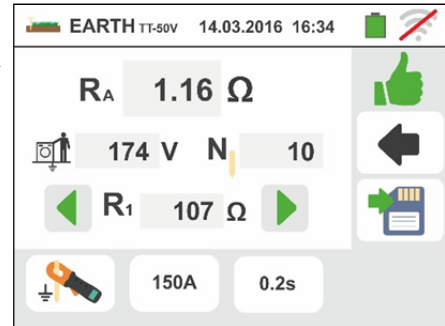

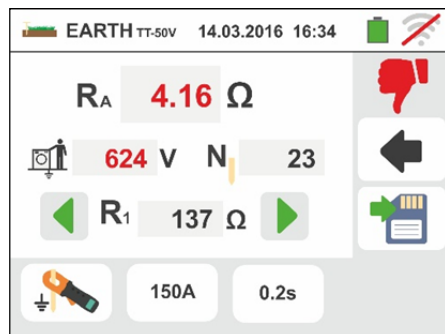

7. In case of negative result (see § 13.7 and § 13.12), the instrument shows the  symbol and the result value appears in red like in the screen to the side.

Press the **SAVE** button or touch the  icon to save the measurement (see § 7.1).



### Rods resistance measurement with clamp T2100 used in an independent way

1. Turn the clamp T2100 on, perform the measurements on each rod of the earth network considered by saving the results in its internal memory (see the user manual of clamp T2100).
2. At the end of the measurement, connect the clamp T2100 to the instrument by inserting the connector into input **In1** and put it in "RS232" mode (see the user manual of clamp T2100). The  $232^{f5}$  symbol appears on the display of the clamp.
3. Touch the  icon. Any data stored in the memory of the clamp is downloaded in the instrument and slides in sequence on the display. At the end of the operation, the  symbol disappears from the display
4. With the clamp connected to the instrument is possible to perform and add other measurements according to the actions described in the previous point 4
5. Press the **GO/STOP** key on the instrument and observe the positive or negative results of the measurement as shown in points 6 and 7 of the previous mode.

#### 6.7.4. Anomalous situations in 3-wire and 2-wire earth measurements

1. When starting a measurement, if the instrument detects an interfering voltage higher than 10V at the volt and ampere circuits input, it does not perform the test and displays the screen to the side.

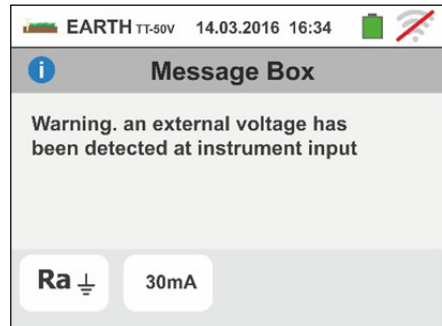

2. When starting a measurement, the instrument checks the continuity of measuring cables. **If the voltmetric circuit (red cable S and green cable ES) is interrupted or its resistance value is too high**, the instrument displays a screen similar to the one on the side.

Check that the terminals are properly connected and that the rod connected to terminal S is not driven into a pebbly or scarcely conductive ground. In this latter case, pour water around the rod to decrease its resistance value (see § 13.13)

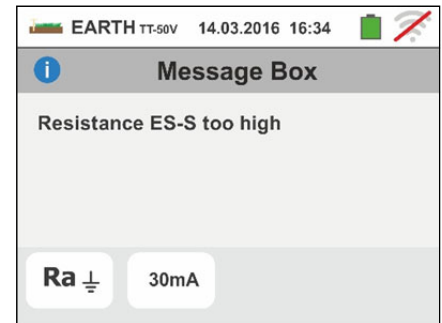

3. When starting a measurement, the instrument checks the continuity of measuring cables. **If the ampermetric circuit (blue cable H and black cable E) is interrupted or its resistance value is too high**, the instrument displays a screen similar to the one on the side.

Check that the terminals are properly connected and that the rod connected to terminal H is not driven into a pebbly or scarcely conductive ground. In this latter case, pour water around the rod to decrease its resistance value (see § 13.13))

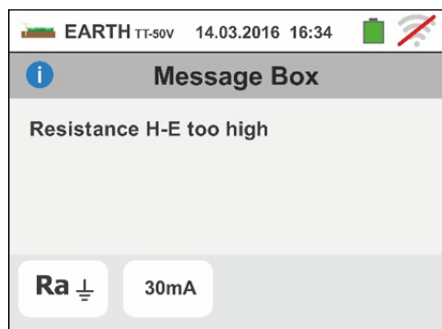

4. When starting a measurement, the instrument checks the situation of B2 (S) and B3 (ES) inputs. In case of reverse of conductors on the installation it blocks the test and the message is shown

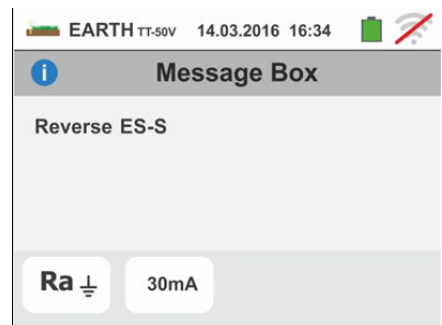

### 6.8. AUX: MEASURE OF AMBIENT PARAMETERS VIA EXTERNAL PROBES

By means of external transducers, this function allows measuring the following environmental parameters:

- °C air temperature in °C by means of thermometric transducer
- °F air temperature in °F by means of thermometric transducer
- Lux(20)** illuminance of white light sources and LED sources by means of luxmetric transducer with a 20Lux capacity
- Lux(2k)** illuminance of white light sources and LED sources by means of luxmetric transducer with a 2kLux capacity
- Lux(20k)** illuminance of white light sources and LED sources by means of luxmetric transducer with a 20kLux capacity
- RH%** air relative humidity by means of humidity transducer
- mV** input DC voltage (without applying any transduction constant)

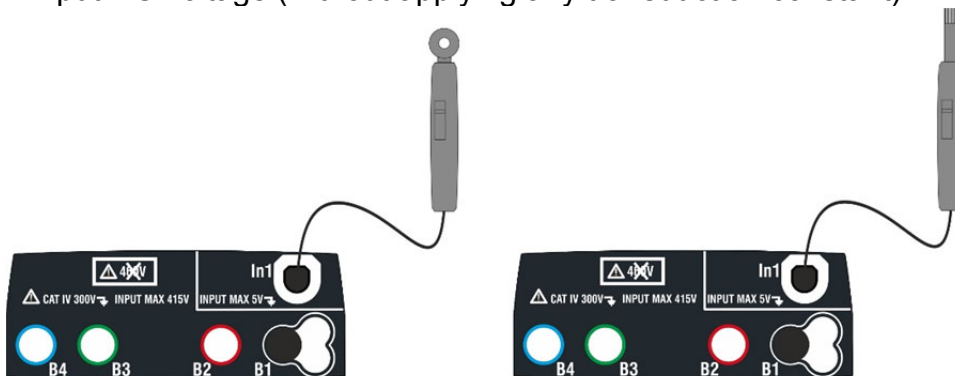
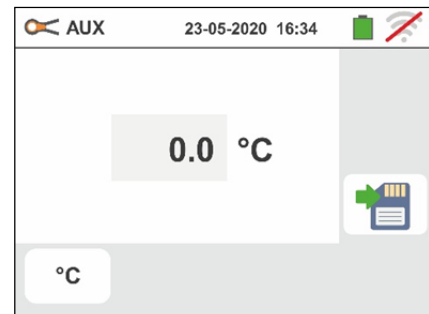

Fig. 33: Measurement of environmental parameters through external probes

1. Touch the icon. The screen to the side appears on the display.

Touch the icon in the lower left corner to set the type of measurement. The following screen appears on the display:



2. Move the left slide bar reference to select the type of measurement among the options: °C (temperature in Celsius degrees), °F (temperature in Fahrenheit degrees), **Lux(20)** (illuminance with 20Lux capacity), **Lux(2k)** (illuminance with 2kLux capacity), **Lux(20k)** (illuminance with 20kLux capacity), **%RH** (relative humidity), **mV** (measurement of DC voltage up to 1V). Move the right slide bar reference to select the model of optional probe for illuminance measurement between the options:

- **HT53** → measurement on white light sources
- **HT53L** → measurement on both white light sources and LED sources of different colors

Confirm the choices by going back to the initial measurement screen.

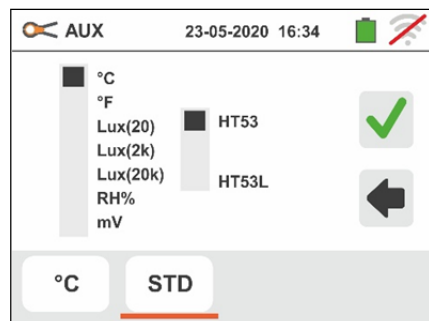

3. **If the HT53L probe is used**, select the color of the LED source under test from the options: **STD (standard white light source), White, Red, Yellow, Green, Blue** and **Purple** as shown in the screen to the side

Confirm the choices by going back to the initial measurement screen

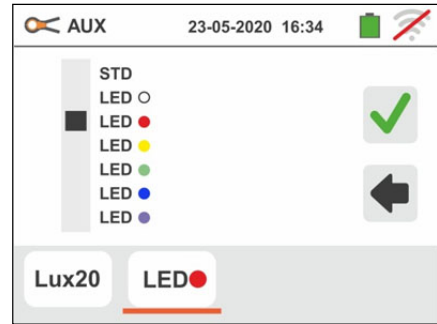

4. Insert in the auxiliary **In1** input the transducer necessary for the desired measurement as shown in Fig. 33

5. The measured value appears on the display in real time as shown in the screen to the side.

Press the **SAVE** button or touch the  icon to save the measurement (see § 7.1).

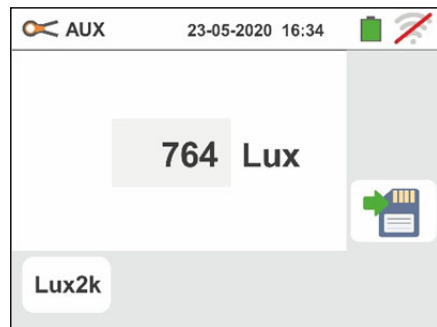

### 6.9. $\Delta V\%$ : VOLTAGE DROP OF MAIN LINES

This feature allows to evaluating the percentage value of voltage drop between two points of a main line in which a protection device is installed and comparing this value to possible limit value specified by guidelines. The following modes are available:

- L-N** Measurement of Phase to Neutral line impedance. The test can be performed also with high resolution (0.1m $\Omega$ ) with optional accessory IMP57
- L-L** Measurement of Phase to Phase line impedance. The test can be performed also with high resolution (0.1m $\Omega$ ) with optional accessory IMP57

#### CAUTION



- The measurement of line impedance or fault loop impedance involves the circulation of a maximum current according to the technical specifications of the instrument (see § 11.1). This could cause the tripping of possible magnetothermal protections at lower tripping currents
- For the calibration of test cables (see § 6.4.2) the instrument consider the values just saved in the correspondent LOOP functions

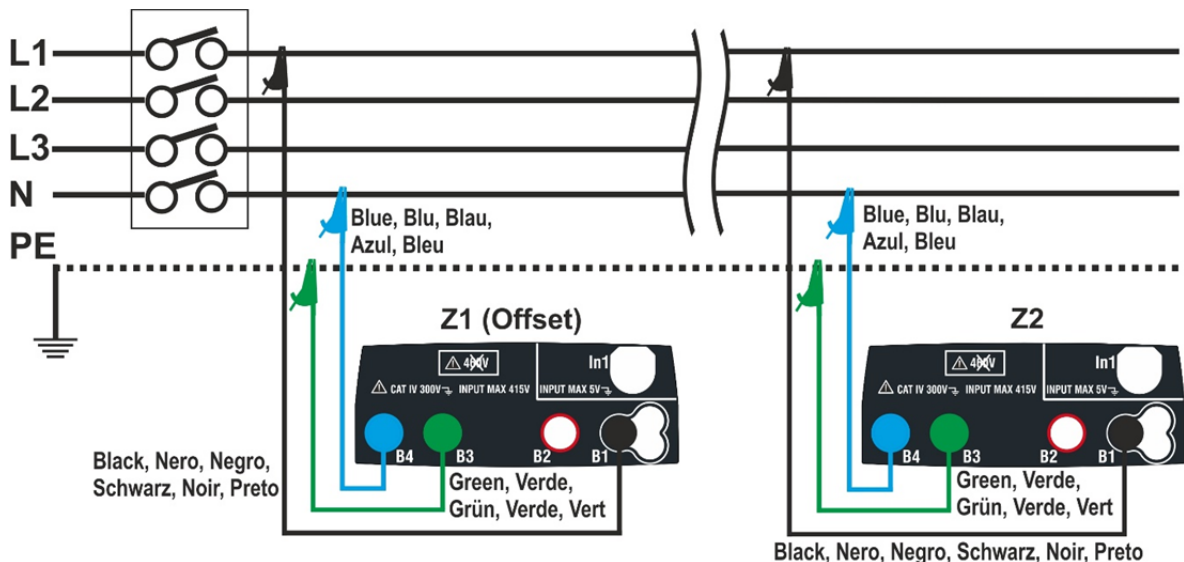

Fig. 34: Connection of the instrument for L-N mode voltage drop measurement

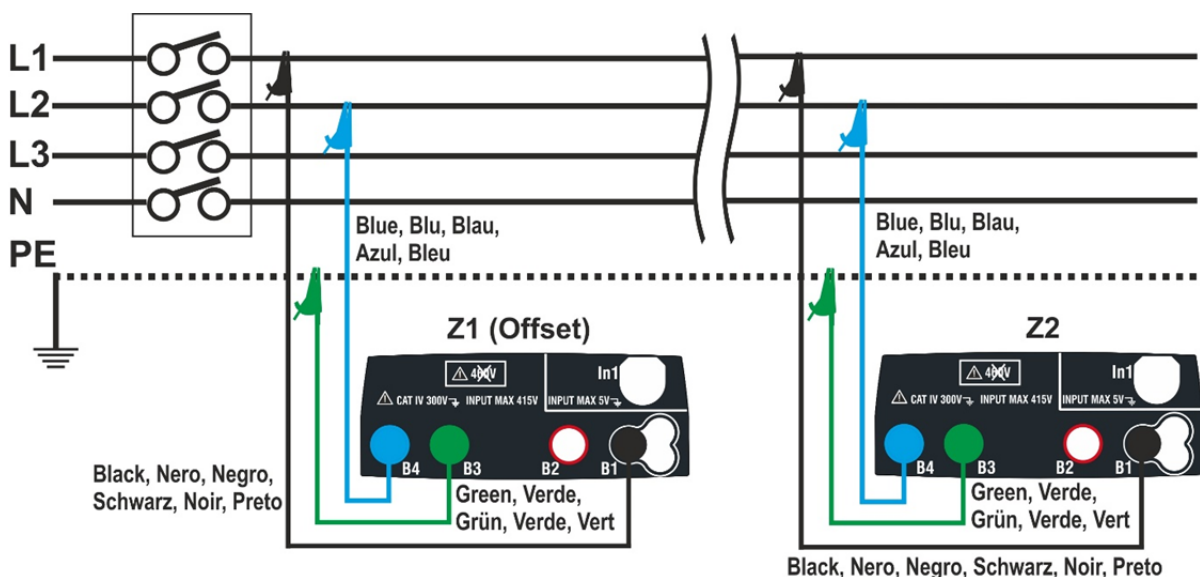

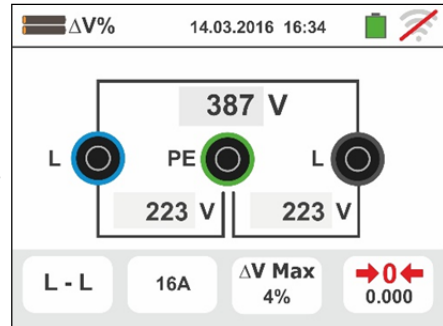

Fig. 35: Connection of the instrument for L-L mode voltage drop measurement





1. Select the option “50Hz or 60Hz” and the reference Phase-Neutral or Phase-Phase voltage in the general settings of the instrument (see § 5.1.4). Touch the  icon. The screen to the side appears on the display. Touch the lower left icon to set the type of measurement. The following screen appears on the display

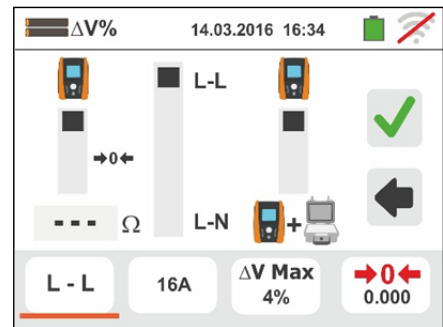

2. Move the second slide bar reference and select the type of measurement between the options: **L-L** (Phase-Phase measurement) or **L-N** (Phase-Neutral measurement).



Move the third slide bar reference and select the  icon to carry out measurement with the optional accessory IMP57 (see § 6.4.13). Move the first slide bar reference thus selecting options:

-  → Impedance measurement performed with the instrument only. With this option the icon “→0←” is shown on the display
-  → Possibility for the operator to manually set the **Offset Z1** impedance without carrying out the first measurement. With this option the icon “→0←” is shown on the display and the following screen appears on the display

3. Touch the icon  to zero the value in the “Ω” field and use the virtual keyboard to set the value of the **Offset Z1** impedance within the range **0.000Ω** to **9999Ω**. Confirm the selection and go back to the previous screen. Touch the second lower icon and set the value of the rated current of the protection device on the main line being tested. The following screen appears on the display

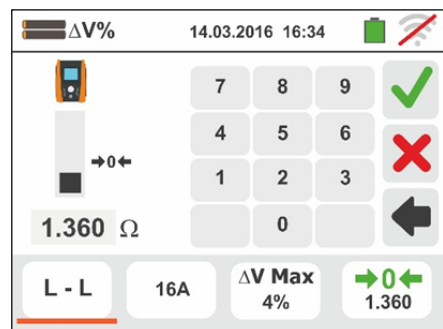

4. Touch the icon  to zero the value in “A” field and use the virtual keyboard to set the value of rated current of protection device in the range **1A** to **9999A**. Confirm selection and go back to the previous screen.

Touch the third lower icon and set the maximum allowed limit value of voltage drop ( $\Delta V\%$ ) for the main line being tested. The following screen appears on the display.

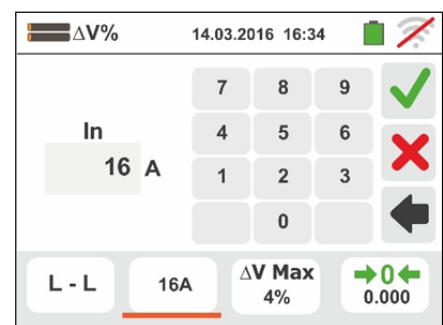

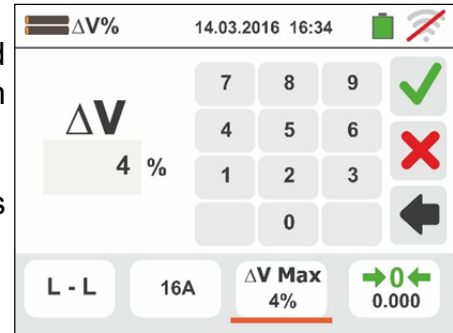

5. Touch the icon  to zero the value in the “%” field and use the virtual keyboard to set the value of  $\Delta V\%$  in the range 1% to 99%.

Confirm the selection and go back to the previous screen



6. Go to step no. 9 in case the value of Z1 (Offset) has been set manually. **In case of the value of Z1 (Offset) has NOT been manually set** connect the instrument to the initial point of the main line being tested (typically downstream to a protection device) according to Fig. 34 or Fig. 35 in order to carry out the first **Z1 (Offset)** impedance measurement. In this case the instrument will measure the impedance upstream of the initial point of the main line being tested taking it as start reference. The following screen (referred to L-L measurement) appears on the display

7. Touch the icon “” to start the first **Z1 (Offset)** impedance measurement. The symbol “” appears on the display during measurement. At the end of measurement the following screen appears on the display

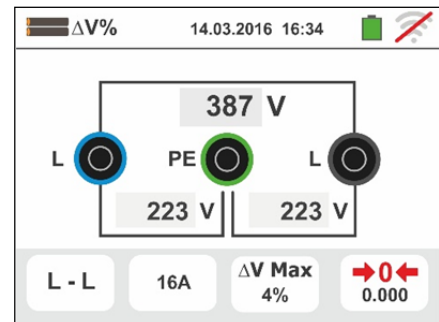

8. The value of **Z1 (Offset)** impedance is shown on the display and is automatically included on the lower right icon, together with the “” symbol to indicate the instantaneous saving of the value

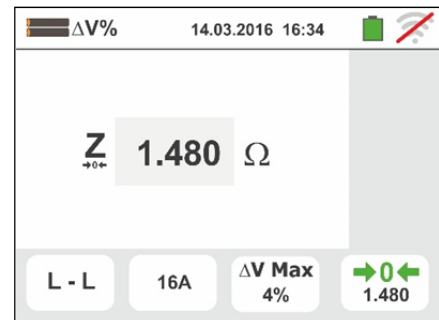

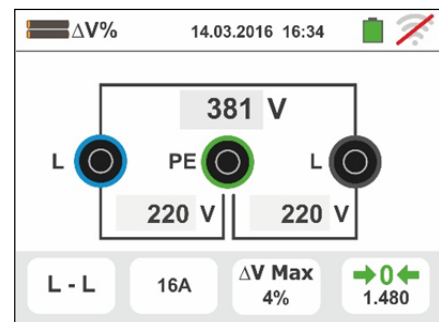

9. Connect the instrument to the final point of the main line being tested according to Fig. 34 or Fig. 35 in order to measure the **Z2** impedance at the end of line. The screen to the side is displayed. Note the previously measured Z1 (Offset) value displayed

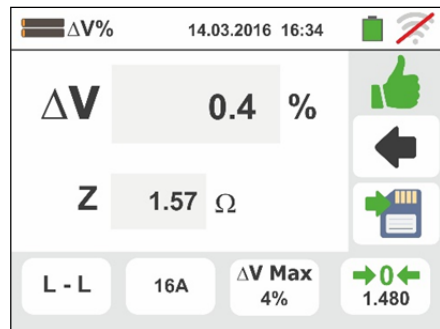

- 10 Press the **GO/STOP** key on the instrument to measure the Z2 impedance and complete the  $\Delta V\%$  voltage drop measurement. During this whole stage, do not disconnect the measuring leads of the instrument from the system being tested

In case of positive result (**maximum percentage value of calculated voltage drop according to § 13.12 < set limit value**), the screen to the side is displayed by the instrument, which contains the value of the **Z2** end of line impedance together the **Z1 (Offset)** value.



Press the **SAVE** button or touch the  icon to save the measurement (see § 7.1)

- 11 In case of negative result (**maximum percentage value of calculated voltage drop according to § 13.12 > set limit value**), the screen to the side is displayed by the instrument, which contains the value of the **Z2** end of line impedance together with the **Z1 (Offset)** value. Press the **SAVE** button or touch the



icon to save measurement (see § 7.1)



### 6.9.1. Anomalous situations

1. If the instrument detects an L-N or L-PE voltage higher than the maximum limit (265V), it does not carry out the test and displays a screen like the one to the side. Check the connection of measuring cables

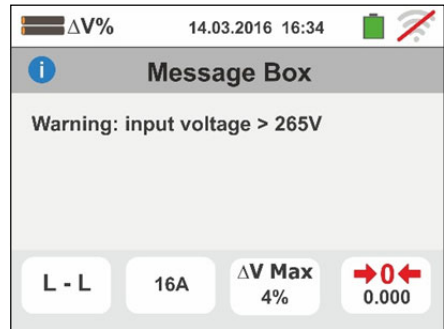

2. If the instrument detects an L-N or L-PE voltage lower than the minimum limit (100V), it does not carry out the test and displays a screen like the one to the side. Check that the system being tested is supplied

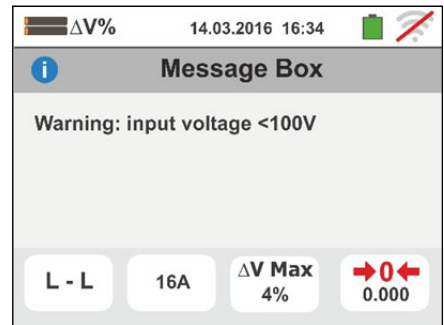

3. If the instrument detects the absence of the signal to terminal B1 (phase conductor), it provides the warning screen shown to the side and blocks the execution of the tests

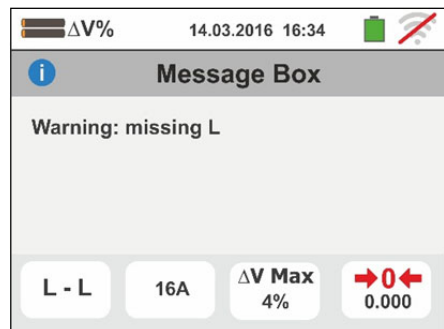

4. If the instrument detects the absence of the signal to terminal B4 (neutral conductor), it provides the warning screen shown to the side and blocks the execution of the tests

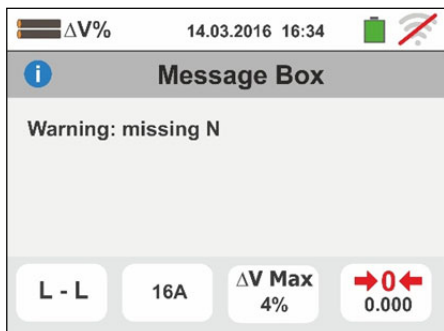

5. If the instrument detects the absence of the signal to terminal B3 (PE conductor), it provides the warning screen shown to the side and blocks the execution of the tests.

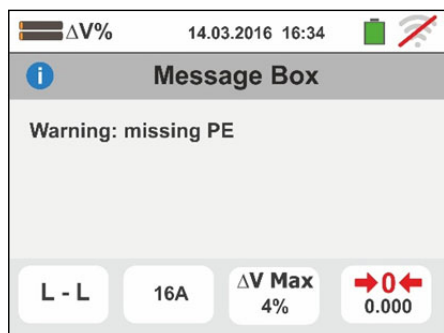

6. If the instrument detects that the phase and neutral leads are inverted, it does not carry out the test and a screen similar to the one reported to the side is displayed. Rotate the shuko plug or check the connection of measuring cables

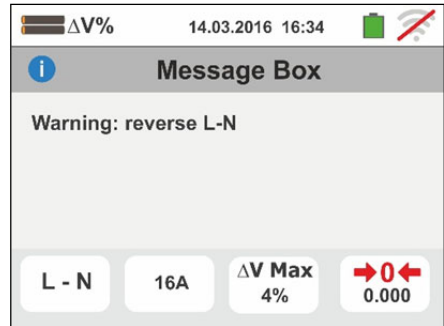

7. If the instrument detects that the phase and PE leads are inverted, it does not carry out the test and a screen similar to the one reported to the side is displayed. Check the connection of measuring cables

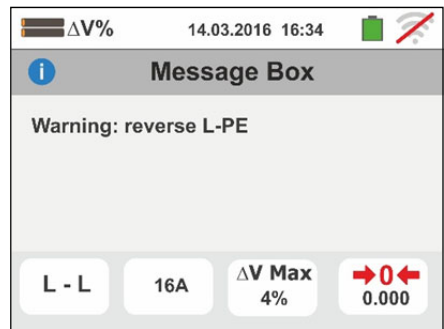

8. If the instrument detects a danger voltage on PE conductor, it does not carry out the test and displays a screen like the one to the side. This message can also appear in case of an insufficient pressure of the **GO/STOP** key

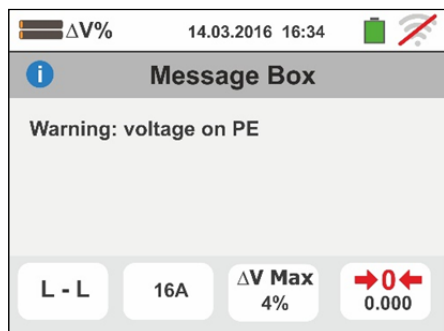

9. If the instrument detects a voltage  $V_N-PE > 50V$  (or  $>25V$  depending on the selection), it does not carry out the test and displays a screen like the one to the side

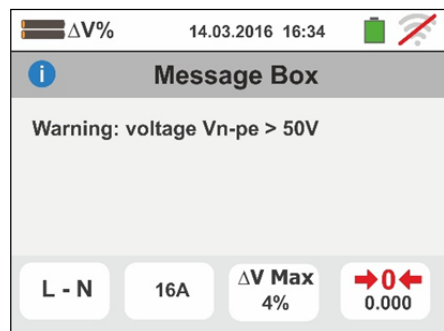

10. If during the measurement the instrument detects an end of line impedance value lower than the initial line impedance value it does not carry out the test and a screen similar to the one reported to the side is displayed. Check the status of the main line being tested

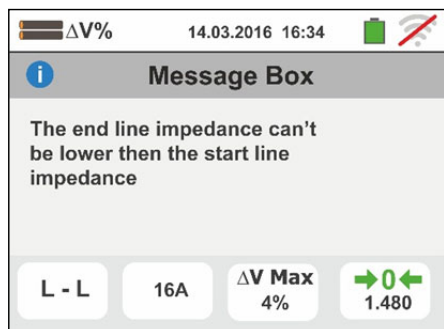

## 6.10. AUTO TEST: AUTOMATIC TEST SEQUENCE (NOTRIP $\frac{\text{~}}{\text{~}}$ , RCD, M $\Omega$ )

This function allows to perform in automatic sequence the following measurements:

- Overall earth resistance without causing the RCD tripping (**NoTrip**  $\frac{\text{~}}{\text{~}}$ )
- Tripping time and tripping current of **General** RCD type A (**M**), AC ( $\text{~}$ ) or B ( $\text{---}$ )
- Insulation resistance in L/N-PE mode

In compliance with the modes described in respective paragraphs.



### CAUTION

Depending on the selected electrical system (TT, TN or IT) some kind of connection and function modes are disabled by the instruments (see Table 2 )

1. Select the reference country (see § 5.1.2), the options “TN” or “TT”, “25 or 50V”, “50Hz or 60Hz” and the reference voltage in the general settings of the instrument (see § 5.1.4). Touch the  icon. The screen to the side appears on the display. Touch the icon on the left side in order to set the type of RCD. The following screen appears on the display

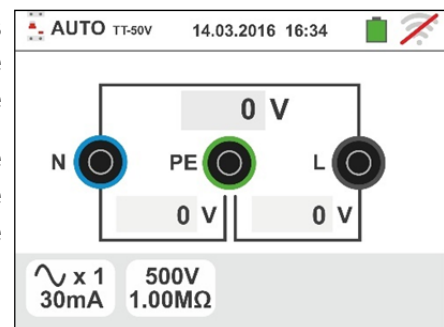

2. Move the left slide bar reference by selecting the waveform of the differential switch between the options:  $\text{~}$  (type AC), **M** (type A),  $\text{---}$  (type B). Move the second slide bar reference by selecting the desired rated current of the differential switch between the options: **6mA, 10mA, 30mA, 100mA, 300mA** Move the third slide bar reference by selecting the type of the test between the following options:

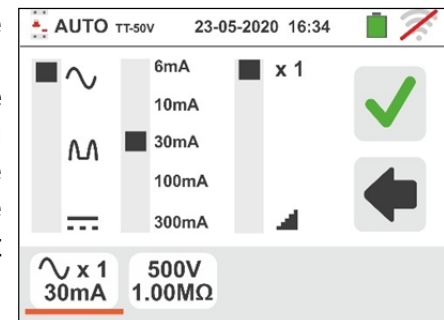

- **X1** → tripping time measurement at nominal current
-  → tripping current measurement

Confirm the choice by going back to the initial measurement screen. Note the presence of the chosen selections

3. Touch the  icon. The screen to the side appears on the display.

Set the test voltage for L-PE and N-PE insulation measurement choosing by the options: **OFF (exclusion of L/N-PE insulation measurement), 50V, 100V, 250V, 500V, 1000VDC** and the minimum limit reference threshold choosing by the options: **0.10M $\Omega$ , 0.23M $\Omega$ , 0.50M $\Omega$ , 1.00M $\Omega$ , 100M $\Omega$**

Confirm the choice by going back to the initial measurement screen

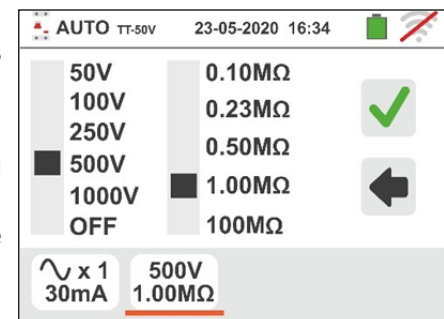



4. Insert the green, blue and black connectors of the three-pin shuko plug into the relevant instrument input terminals B3, B4, B1. As an alternative, use the single cables and apply the relevant alligator clips to the free ends of the cables. It is also possible to use the remote lead by inserting its multipolar connector into the input lead B1. Connect the shuko plug, the alligator clips or the remote lead to the electrical mains according to Fig. 12, Fig. 13, Fig. 14, Fig. 15 and Fig. 16
5. Note the correct voltage values between L-N and L-PE as shown in the screen to the side

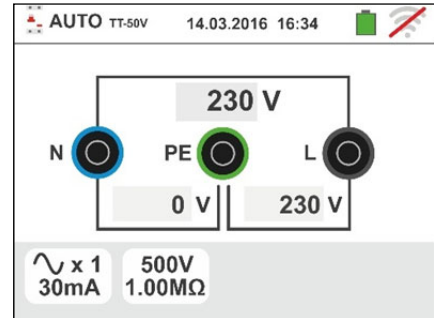

#### 6.10.1. AutoTest in TT systems

6. Press the **GO/STOP** key for few seconds or the **START** key on the remote lead. During this whole stage, do not disconnect the measuring leads of the instrument from the system under test. In case of **RCD tripping time measurement** selection the screen to the side appears on the display when the hourglass icon indicates the performance of the test

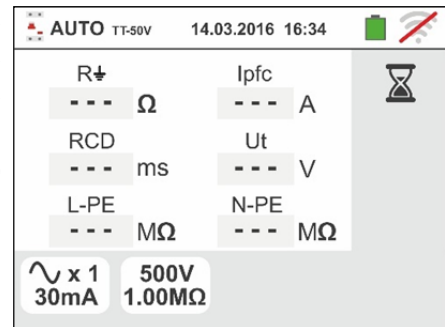

7. Press the **GO/STOP** key for few seconds or the **START** key on the remote lead. During this whole stage, do not disconnect the measuring leads of the instrument from the system under test. In case of **RCD tripping current measurement** selection the screen to the side appears on the display when the hourglass icon indicates the performance of the test

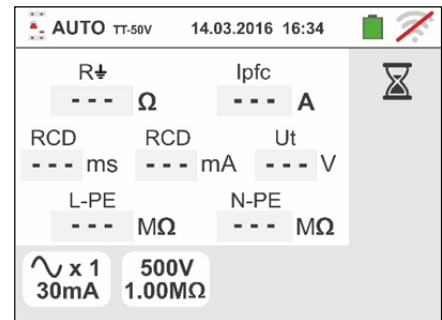

8. In case of **positive** result of the three test sequentially performed as **NoTrip** (see § 13.8), **RCDX1** (see § 13.4) and **MΩ L/N-PE** the symbol is shown and the screen to the side is displayed by the instrument

Press the **SAVE** button or touch the icon to save the measurement (see § 7.1)

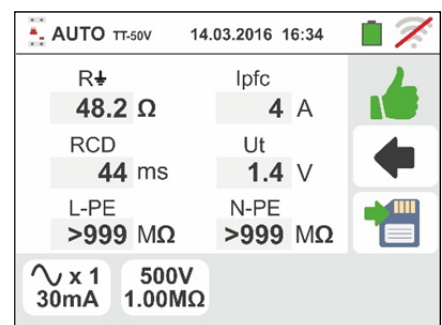

9. In case of **positive** result of the three test sequentially performed as **NoTrip** (see § 13.8), **RCD** (see § 13.4) and **MΩ L/N-PE** the symbol is shown and the screen to the side is displayed by the instrument.

Press the **SAVE** button or touch the icon to save the measurement (see § 7.1)

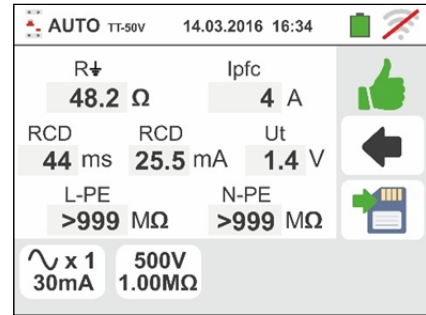

- 10 In case of **negative** result of the **NoTrip** , the auto test is automatically blocked, the symbol is shown and the screen to the side is displayed. Note red value of the contact voltage

Press the **SAVE** button or touch the icon to save the measurement (see § 7.1)

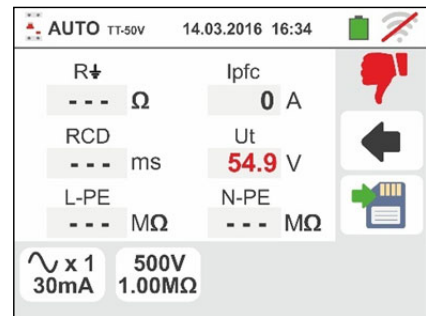

- 11 In case of **negative** result of the **RCDX1**, the auto test is automatically blocked, the symbol is shown and the screen to the side is displayed. Note red value of the tripping time

Press the **SAVE** button or touch the icon to save the measurement (see § 7.1)

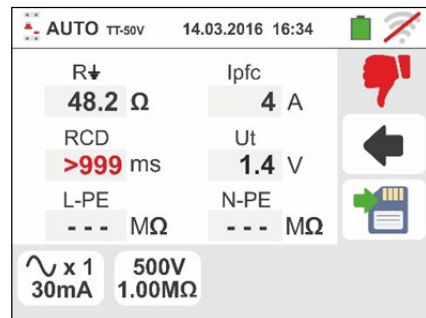

- 12 In case of **negative** result of the **RCD** , the auto test is automatically blocked, the symbol is shown and the screen to the side is displayed. Note red value of the tripping current

Press the **SAVE** button or touch the icon to save the measurement (see § 7.1)

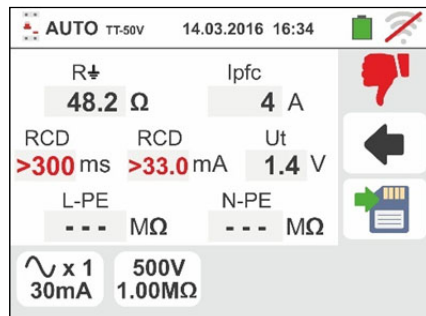

- 13 In case of **negative** result of the **MΩ L-PE**, the auto test is automatically blocked, the symbol is shown and the screen to the side is displayed. Note red value (lower than minimum set threshold) of the L-PE insulation resistance

Press the **SAVE** button or touch the icon to save the measurement (see § 7.1)

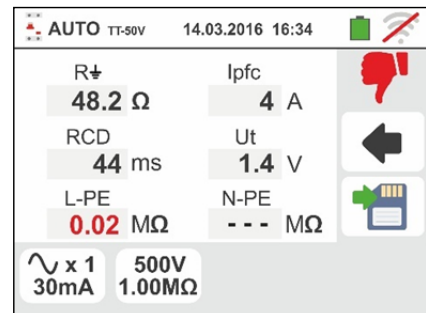

- 14 In case of **negative** result of the **MΩ N-PE**, the auto test is automatically blocked, the symbol is shown and the screen to the side is displayed. Note red value (lower than minimum set threshold) of the N-PE insulation resistance

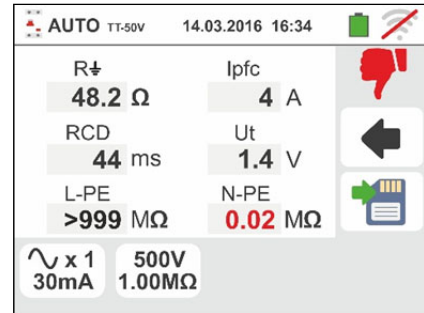

Press the **SAVE** button or touch the icon to save the measurement (see § 7.1)

### 6.10.2. AutoTest in TN systems

6. Press the **GO/STOP** key for few seconds or the **START** key on the remote lead. During this whole stage, do not disconnect the measuring leads of the instrument from the system under test. In case of **RCD tripping time measurement** selection the screen to the side appears on the display when the hourglass icon indicates the performance of the test

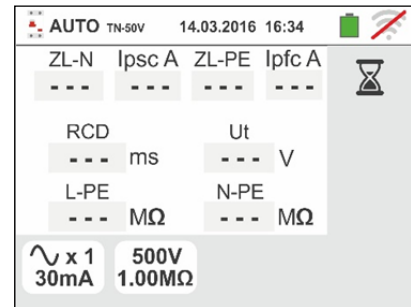

7. Press the **GO/STOP** key for few seconds or the **START** key on the remote lead. During this whole stage, do not disconnect the measuring leads of the instrument from the system under test. In case of **RCD tripping current measurement** selection the screen to the side appears on the display when the hourglass icon indicates the performance of the test

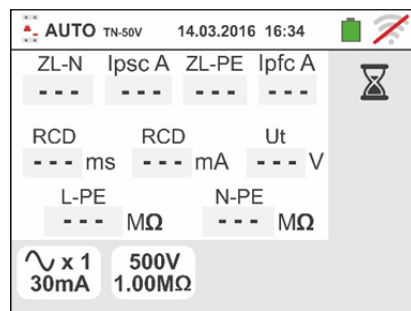

8. In case of **positive** result of the three test sequentially performed as **NoTrip** ( $Z_{L-N}$  and  $Z_{L-PE} < 199\Omega$ ), **RCDX1** (see § 13.4) and **MΩ L/N-PE** the symbol is shown and the screen to the side is displayed by the instrument

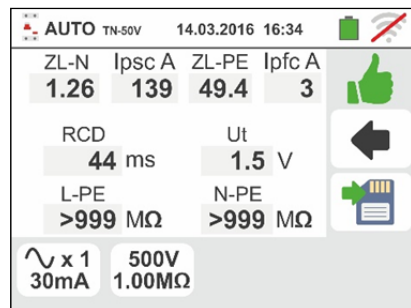

Press the **SAVE** button or touch the icon to save the measurement (see § 7.1)

9. In case of **positive** result of the three test sequentially performed as **NoTrip** ( $Z_{L-N}$  and  $Z_{L-PE} < 199\Omega$ ), **RCD** (see § 13.4) and **MΩ L/N-PE** the symbol is shown and the screen to the side is displayed by the instrument

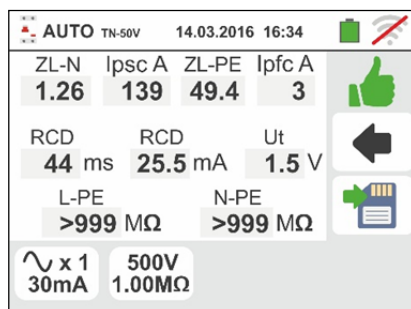

Press the **SAVE** button or touch the icon to save the measurement (see § 7.1)

- 10 In case of **negative** result of the **NoTrip** ( $Z_{L-N}$  and/or  $Z_{L-PE} > 199\Omega$ ), the auto test is automatically blocked, the symbol is shown and the screen to the side is displayed. Note red value of the relative Loop impedance

Press the **SAVE** button or touch the icon to save the measurement (see § 7.1)

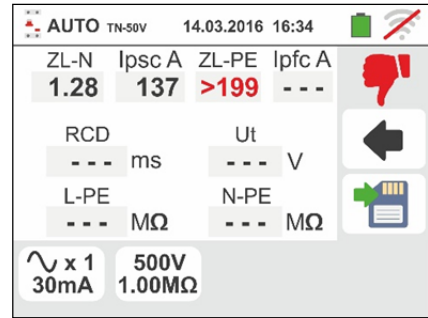

- 11 In case of **negative** result of the **RCDX1**, the auto test is automatically blocked, the symbol is shown and the screen to the side is displayed. Note red value of the tripping time

Press the **SAVE** button or touch the icon to save the measurement (see § 7.1)

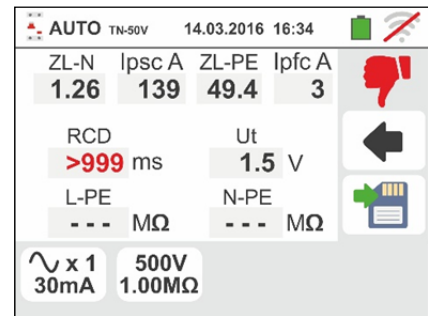

- 12 In case of **negative** result of the **RCD**, the auto test is automatically blocked, the symbol is shown and the screen to the side is displayed. Note red value of the tripping current

Press the **SAVE** button or touch the icon to save the measurement (see § 7.1)

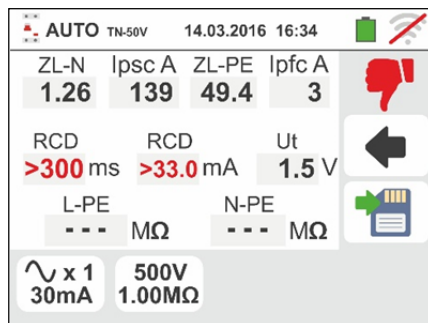

- 13 In case of **negative** result of the **MΩ L-PE**, the auto test is automatically blocked, the symbol is shown and the screen to the side is displayed. Note red value (lower than minimum set threshold) of the L-PE insulation resistance

Press the **SAVE** button or touch the icon to save the measurement (see § 7.1)

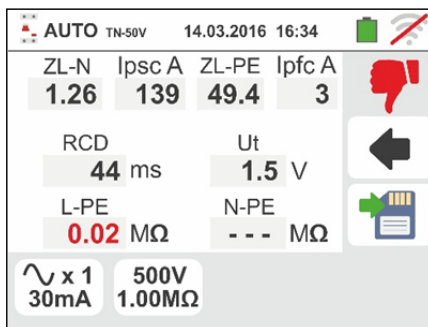

- 14 In case of **negative** result of the **MΩ N-PE**, the auto test is automatically blocked, the symbol is shown and the screen to the side is displayed. Note red value (lower than minimum set threshold) of the N-PE insulation resistance

Press the **SAVE** button or touch the icon to save the measurement (see § 7.1)

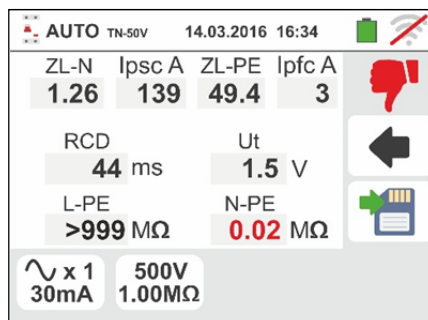

### 6.10.3. Anomalous situations

1. If the instrument detects an L-N or L-PE voltage higher than the maximum limit (265V), it does not carry out the test and displays a screen like the one to the side. Check the connection of measuring cables

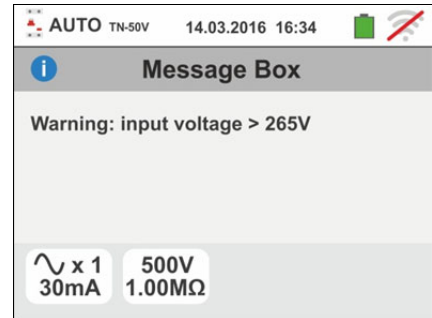

2. If the instrument detects an L-N or L-PE voltage lower than the minimum limit (100V), it does not carry out the test and displays a screen like the one to the side. Check that the system being tested is supplied



3. If the instrument detects the absence of the signal to terminal B1 (phase conductor), it provides the warning screen shown to the side and blocks the execution of the tests



4. If the instrument detects the absence of the signal to terminal B4 (neutral conductor), it provides the warning screen shown to the side and blocks the execution of the tests



5. If the instrument detects the absence of the signal to terminal B3 (PE conductor), it provides the warning screen shown to the side and blocks the execution of the tests.





6. If the instrument detects that the phase and neutral leads are inverted, it does not carry out the test and a screen similar to the one reported to the side is displayed. Rotate the shuko plug or check the connection of measuring cables



7. If the instrument detects that the phase and PE leads are inverted, it does not carry out the test and a screen similar to the one reported to the side is displayed. Check the connection of measuring cables



8. If the differential switch being tested trips during the preliminary checks (performed automatically by the instrument before executing the selected test), the instrument does not carry out the test and displays a screen like the one to the side. Check that the IdN set value is consistent with the differential switch in question and that all loads connected downstream of it are disconnected



9. If the instrument detects a danger voltage on PE conductor, it does not carry out the test and displays a screen like the one to the side. **This message can also appear in case of an insufficient pressure of the GO/STOP key**



- 10 If the instrument detects a dangerous contact voltage  $U_t$  (over the set limit 25V or 50V) in the starting pre-test, it provides the warning screen shown to the side and blocks the execution of the tests. Check the PE conductor and earth plant efficiency





11 If the instrument detects a voltage value higher than 10V at its terminals, it does not carry out the L/N-PE insulation test, gives out a long sound and the screen reported here to the side is displayed

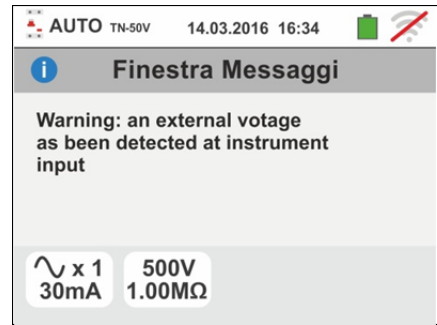

### 6.11. PQA: REAL TIME MEASUREMENT OF MAIN PARAMETERS

This feature allows to performing real time measurements of voltage, current (with optional transducer clamp), powers, power factors and harmonic analysis on Single phase and Three phase balanced systems.

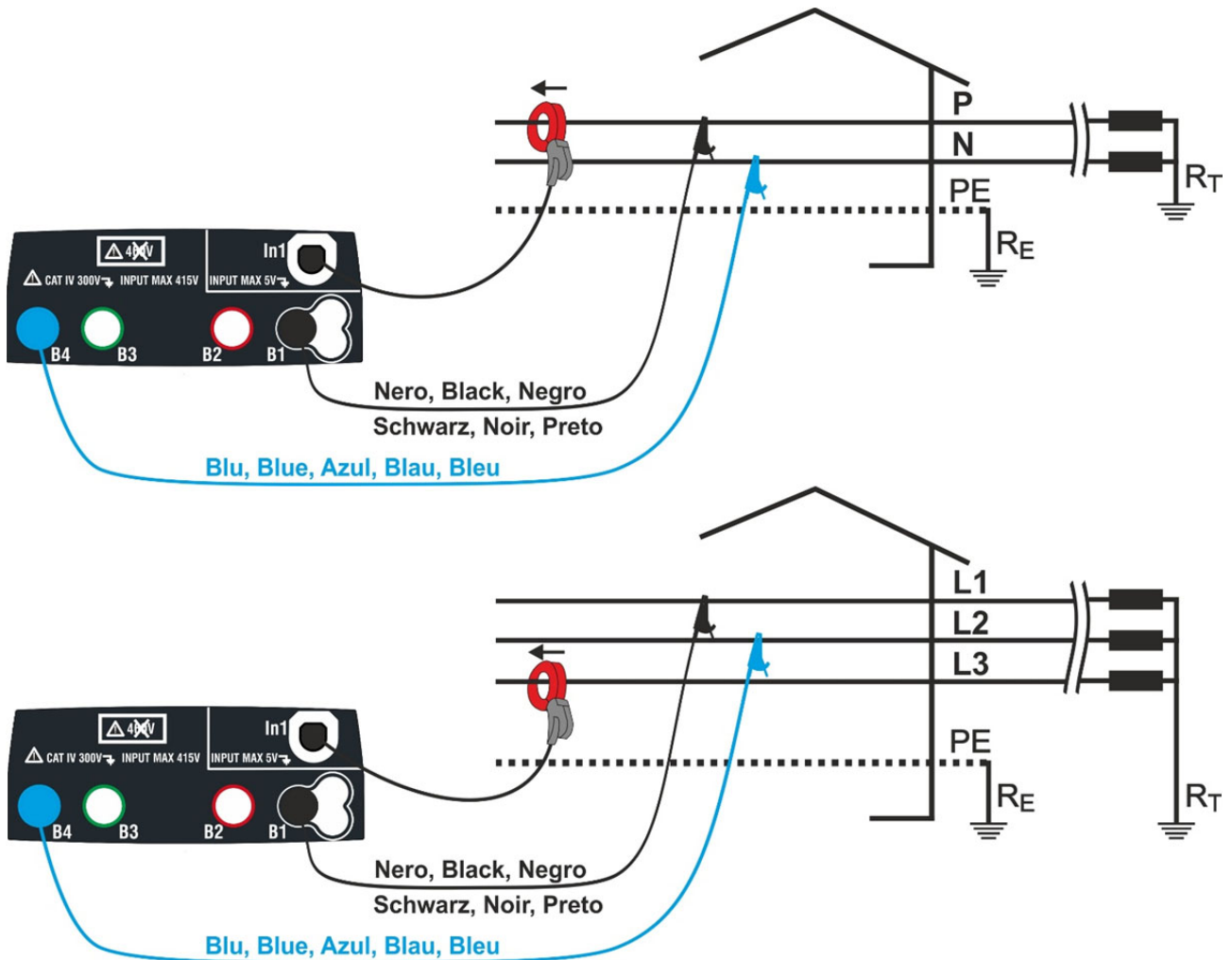
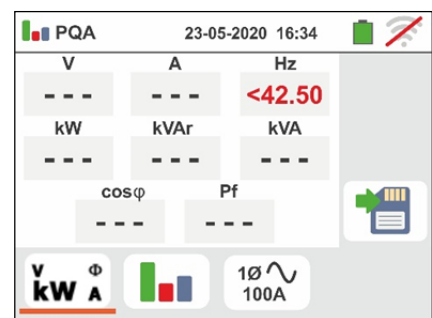



Fig. 36: Connection for measurement on Single phase installations

Fig. 37: Connection for measurement on Three phase balanced installations

1. Touch the icon . The display shows the screen on the right.

Touch the right bottom icon to set the measurement mode and the full scale of used transducer clamp. The display shows the following screen



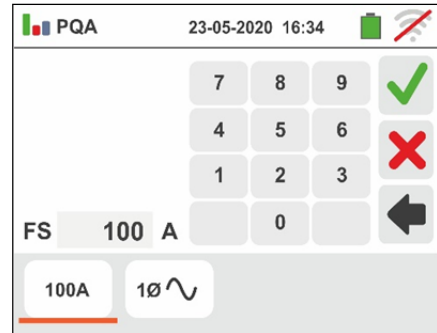

2. Touch the icon  to zero the value into the “FS” field and use the virtual keyboard to set the full scale of the used transducer clamp. This value is within the range: **1A ÷ 3000A**

Touch the right bottom icon to set the type of measurement. The display shows the following screen





3. Move the reference of the slide bar to select the followed available options:

- **1Ø**  → Measurement on Single phase plant
- **3Ø**  → Measurement on Three phase balanced

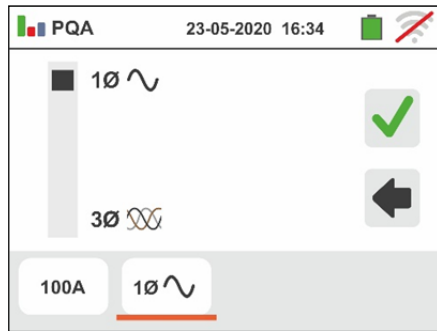

Confirm the choice by going back to the initial measurement screen



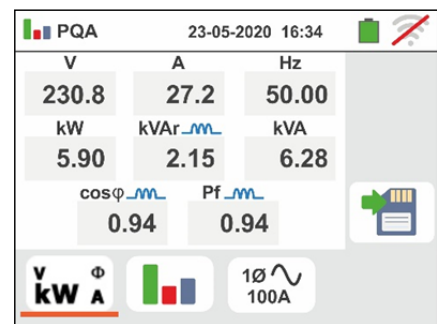

4. Insert the blue and black connectors into the corresponding B4 and B1 input terminals of the instrument. Insert the remaining free end of the cables in the corresponding crocodiles or tips. Connect crocodiles or test leads to the phase P and N according to Fig. 36 for the measurement of the voltage in Single phase plant or at L1 and L2 phase according to Fig. 37 for the measurement of voltage in a Three phase balanced plant. Connect the clamp to **In1** input of the instrument and to the phase conductor for Single phase or to the L3 phase for Three phase balanced systems. The arrow on the clamp must follow the direction in which the current normally flows from the generator to the load, as shown in Fig. 36 and Fig. 37

5. The screen to the side shows the real time values of electrical parameters in a Single phase plant. For the meaning of the parameters refer to § 13.15. The symbols “” and “” show the type Inductive or Capacitive of the load respectively.

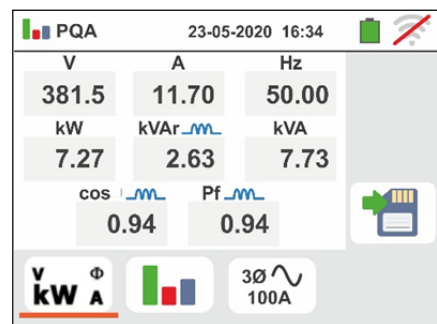

6. The screen to the side shows the real time values of electrical parameters in a Three phase balanced plant. For the meaning of the parameters refer to § 13.15. The symbols “” and “” show the type Inductive or Capacitive of the load respectively.



Press the **SAVE** button or touch the  icon to save the measurement (see § 7.1)

- Touch the icon “

The display shows the histogram graphic of the percentage amplitude relative to the fundamental and the voltage harmonic V1N (Single phase) or VL1-L2 (Three phase balanced) and the fundamental and the current harmonics from **1<sup>th</sup> up to 25<sup>th</sup> order**. A blue frame immediately identifies the harmonic of higher amplitude (except for the fundamental). The display shows the numeric value of the harmonics amplitudes (identified by the “**hxx**” symbol) and the THD% (see § 13.14) appear in the right side of the display.

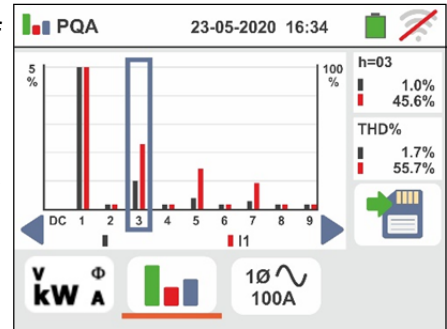

Use the arrow keys “◀” or “▶” or touch the correspondent icon on the display to decrease or increase the order of the harmonics

Press the **SAVE** button or touch the  icon to save the measurement (see § 7.1)

## 6.12. EVSE: SAFETY TEST FOR ELECTRIC CAR CHARGING STATIONS

This function allows to perform a complete electrical safety test on the charging stations of electric cars (**EVSE** - **E**lectrical **V**ehicle **S**upply **E**quipment) systems in connection with the optional adapter **EV-TEST100** capable of simulating the presence of an electric vehicle, measuring the output voltage signals and simulate fault conditions in accordance with the reference IEC/EN61851-1 and IEC/EN60364-7-722 guidelines.



### CAUTION

- The EVSE test is only available for instruments of Gx family with measurement category CAT IV 300V correspondent to the list indicated in the Table 1
- The EVSE test is not possible for IT systems

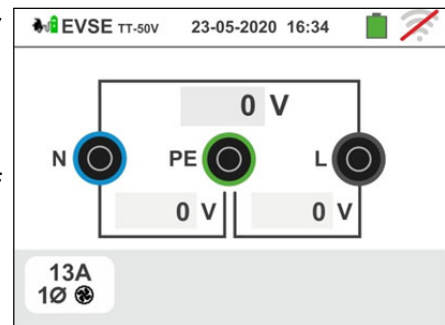

1. Select the options “TN, TT or “IT”, “25 or 50V”, “50Hz or 60Hz” and the reference voltage in the general settings of the instrument (see § 5.1.4). Touch the  icon. The screen to the side appears on the display. Touch the lower icon in order to set the parameter of EVSE system under test. The following screen appears



2. Move the reference of the left sliding bar by selecting one of the followed parameters:

- **1Ø** → test on Single phase EVSE system
- **3Ø** → test on Three phase EVSE system

Move the reference of the central sliding bar by selecting one of the followed parameters:

-  → EVSE system in unventilated environment
-  → EVSE system in ventilated environment

Move the reference of the right sliding bar by selecting the maximum rated output current of the EVSE system as defined by the reference standard among the options: **13A, 20A, 32A and 63A**

Confirm the choice by going back to the initial measurement screen

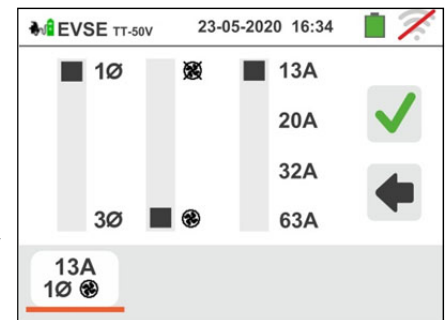

3. Connect the terminals L1, PE and N of the optional EV-TEST100 adapter respectively to the inputs **B1, B3** and **B4** of the instrument and connect the adapter to the **In1** input of the instrument via cable C100EV supplied with the same adapter as shown in the Fig. 38
4. Check the zero values of the voltages between the terminals L-N, L-PE and N-PE to indicate the correct situation on the EVSE system

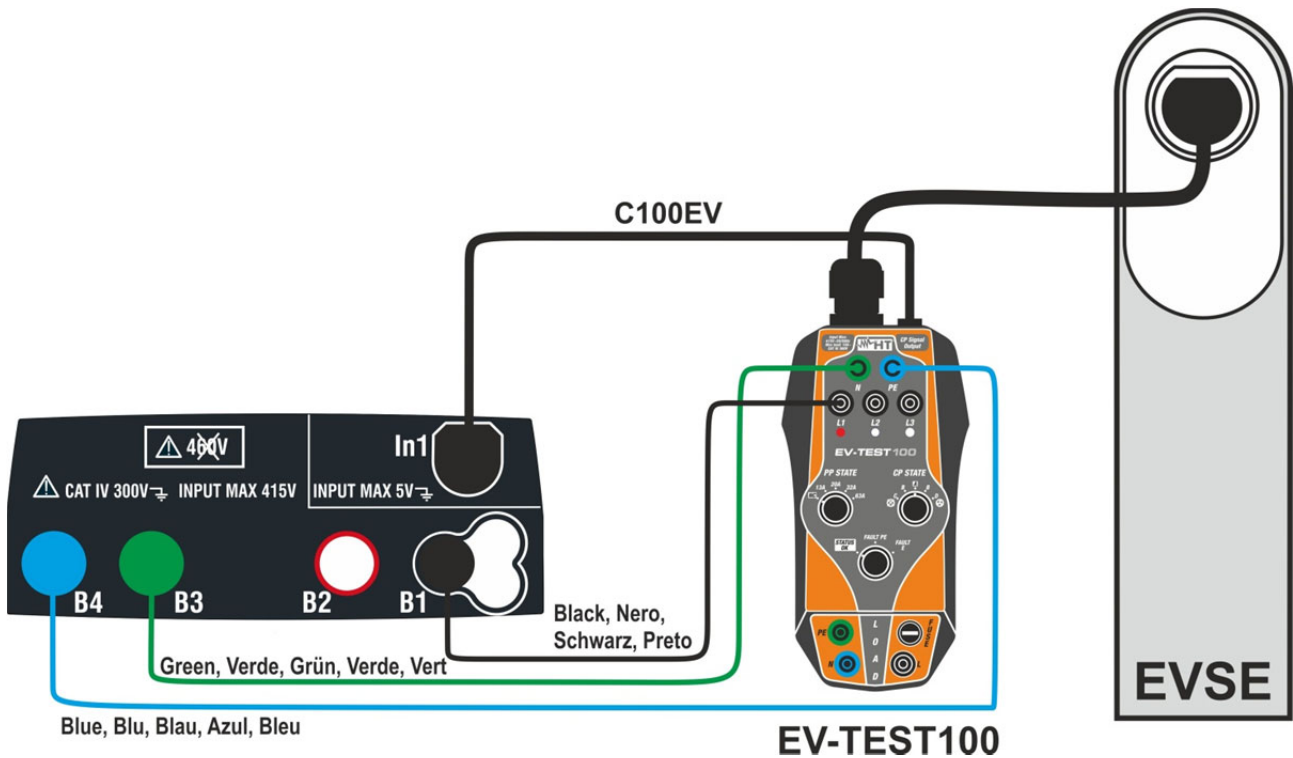

Fig. 38: Connection of the EV-TEST100 adapter to the instrument and the EVSE system

Test 1 → Continuity test of PE protective conductor of the EVSE system

5. Press **GO/STOP** button to start the test sequence. The screen to the side is shown on the display. Connect the instrument to the adapter as shown in the diagram on the display (input B4 on input **E** and input **B1** to the main earth collector of the system). **Act on the three adapter selectors by setting the followed positions as shown by the instrument by flashing red/blue indications:**

- PP State → **NC**
- CP State → **A**
- Fault → **OK**

Press the icon to continue with the test or press the icon to exit the test and return to the initial screen

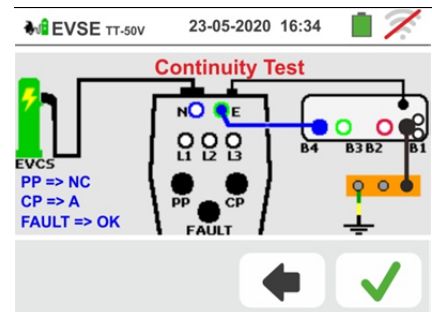

6. The RPE test is performed by the instrument **only in AUTO mode**. Set the limit threshold value and calibrate the measurement cables as shown in § 6.1

Press the **GO/STOP** button. The followed screen is shown on the display

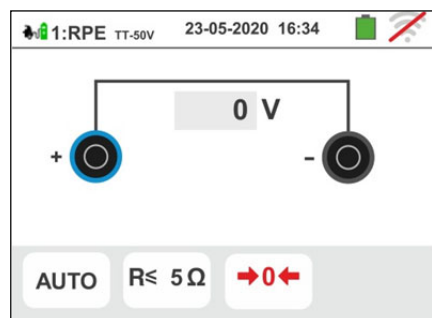





7. The value of the result is shown in the upper part of the screen while the partial values of the tests with inverted polarity of the test source in addition to the actual test currents are shown in the fields "R +" and "R-"

The symbol  indicates the correct result of the measurement.

Press again the **GO/STOP** key to repeat the test

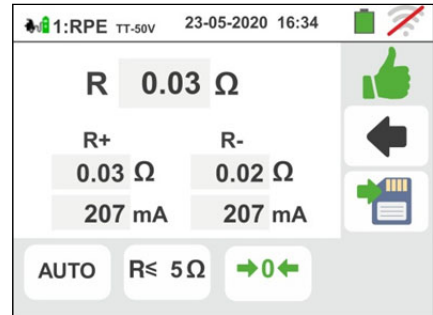
Press **SAVE** key or touch the icon  for the partial saving of the test and to continue with the next test (point 10)



8. At the end of the test if the value of the measured resistance is higher than the limit set, the screen to the side is shown on the display. The value is shown in red and the symbol  indicates the non-ok result of the measurement. The indication ">1999Ω" indicates the out of scale of the instrument.

Press again the **GO/STOP** key to repeat the test

Press the **SAVE** key or touch the icon  for the partial saving of the test and to **end the test sequence**. The instrument shows the message shown in the followed screen for a few seconds

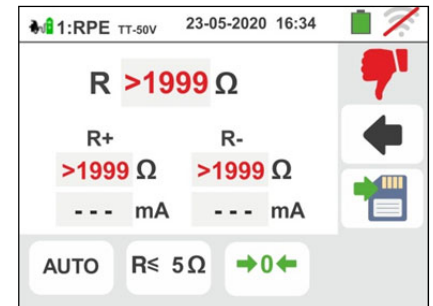

9. Repeat the sequence again if necessary

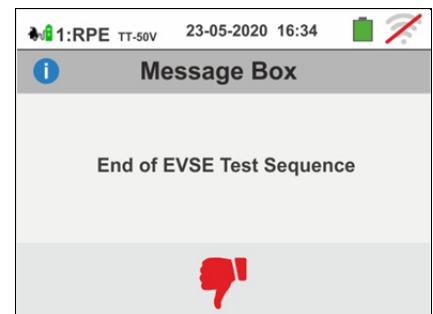

## Test 2 → Insulation measurement of EVSE system

10 Connect the instrument to the adapter as shown in the screen on the display (input **B4** on input **N**, input B3 on input **E** and input **B1** on input **L1**)

Act on the three adapter selectors by setting the followed positions as shown by the instrument by flashing red/blue indications:

- PP State → **NC**
- CP State → **A**
- Fault → **OK**

Press the icon to continue with the test or press the icon to exit the test and return to the initial screen

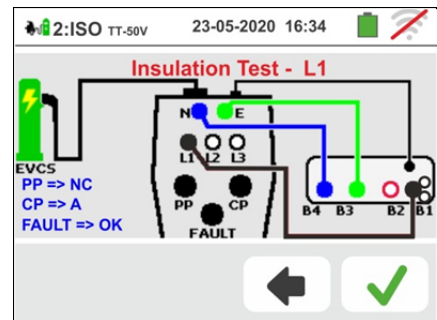

11 The test is performed by the instrument only in AUTO L/N-PE mode. Refer to § 6.2.2 for the description on setting of test parameters

Press the **GO/STOP** button. The followed screen is shown on the display

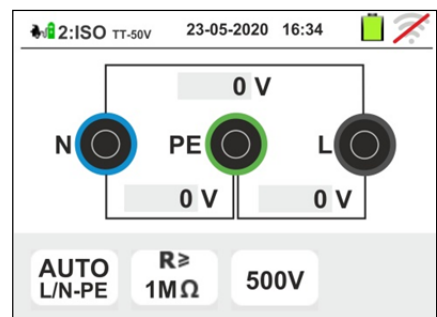

12 For single-phase EVSE systems, the measurement result is shown in the screen to the side. The values of the real test voltages are shown on the display. The

symbol indicates the correct result of the measurement.

Press again the **GO/STOP** key to repeat the test

Press the **SAVE** key or touch the icon for the partial saving of the test and continue with the next test (point 20)

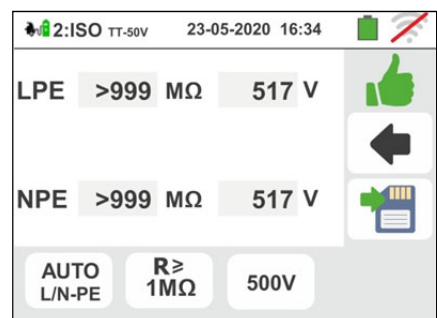

13 For three-phase EVSE systems, the measurement result of the **first L1PE test** is shown in the screen to the side. The values of the real test voltages are shown on the display

The symbol indicates the correct result of the measurement.

Press again the **GO/STOP** key to repeat the test

Press the **SAVE** key or touch the icon for the partial saving of the test and continue with the next test on L2 phase. The followed screen is shown on the display

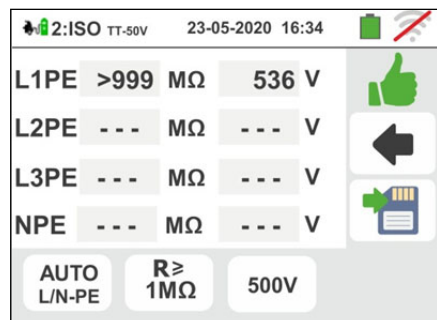

- 14 Connect the input **B1** on the input **L2** of adapter as shown in the screen to the side

Press the icon to continue with the test or press the icon to exit the test and return to the initial screen

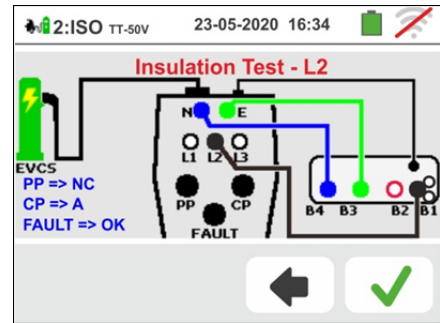

- 15 The measurement result of the **L2PE test** is shown in the screen to the side. The values of the real test voltages are shown on the display

The symbol indicates the correct result of the measurement.  
Press again the **GO/STOP** key to repeat the test

Press the **SAVE** key or touch the icon for the partial saving of the test and continue with the next test on L3 phase. The followed screen is shown on the display

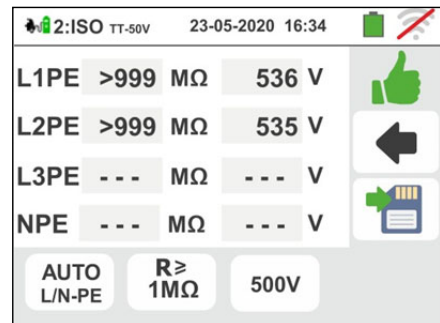

- 16 Connect the input **B1** on the input **L3** of adapter as shown in the screen to the side

Press the icon to continue with the test or press the icon to exit the test and return to the initial screen

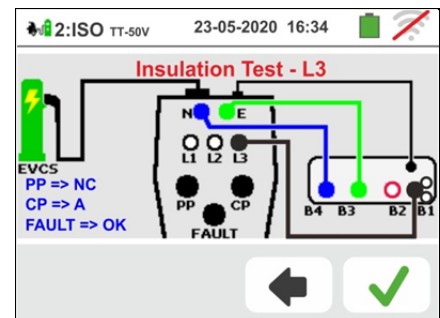

- 17 The measurement result of the **L3PE and NPE test** is shown in the screen to the side. The values of the real test voltages are shown on the display

The symbol indicates the correct result of the measurement.  
Press again the **GO/STOP** key to repeat the test

Press the **SAVE** key or touch the icon for the partial saving of the test and continue with the next test (point 20)

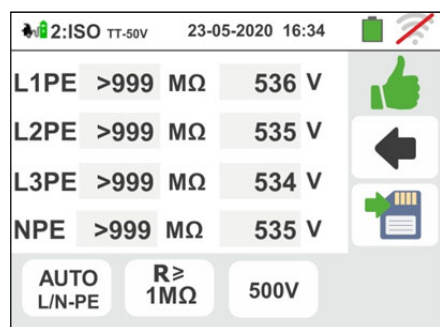

18 At the end of the test, if the value of the measured resistance in one or both test should be lower than the set limit, the screen to the side is shown on the display.

The value is shown in red and the  symbol indicates the negative result of the measurement

Press again the **GO/STOP** key to repeat the test



Press the **SAVE** key or touch the icon  for the partial saving of the test and to end the test sequence. The instrument shows the message shown in the followed screen for a few seconds

19 Repeat the sequence again if necessary

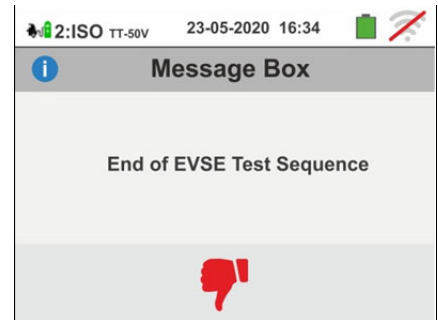

**Test 3 → Check states of the EVSE system**

The purpose of this test (consisting of 6 steps) is to check all the internal states of the EVSE system in accordance with the prescriptions of the reference standards by performing simulations with the EV-TEST100 accessory connected. The situations considered are the following:

State	Select. CP	Select. PP	Select. FAULT	Ventilation	Parameters checked	Limits	Outcome OK	Outcome NO OK	
A	A	NC	OK		VL1N	$\leq 10V$		$> 10V$	
					VL1-PE	$\leq 10V$		$> 10V$	
					VN-PE	$\leq 10V$		$> 10V$	
					VCP (peak)	$12V \pm 0.6V$			-
					Frequency	DC (0Hz)			-
					Charge current	$\leq 0A$			-
B	B	Nominal current	OK		Check plug		locked plug	unlocked plug	
B	B	Nominal current	OK		VL1N	$\leq 10V$		$> 10V$	
					VL1-PE	$\leq 10V$		$> 10V$	
					VN-PE	$\leq 10V$		$> 10V$	
					VCP (peak)	$9V \pm 0.6V$			-
					Frequency	DC (0Hz)			-
					Charge current	$\leq 0A$			-
C	C	Nominal current	OK		VL1N	$V_{nom} \pm 10\%$		external interval	
					VL1-PE	$V_{nom} \pm 10\%$		$> 25V$	
					VN-PE	$\leq 25V$		-	
					VCP (peak)	$6V \pm 0.53V$			-
					Frequency	$1kHz \pm 0.5\%$			-
					Charge current	calculated			-
D	D	Nominal current	OK		VL1N	$V_{nom} \pm 10\%$		external interval	
					VL1-PE	$V_{nom} \pm 10\%$		$> 25V$	
					VN-PE	$\leq 25V$		-	
					VCP (peak)	$3V \pm 0.6V$			-
					Frequency	$1kHz \pm 0.5\%$			-
					Charge current	calculated			-
FPE	C	Nominal current	PE		VL1N	$\leq 10V$		$> 10V$	
					VL1-PE	$\leq 10V$		$> 10V$	
					VN-PE	$\leq 10V$		$> 10V$	
					VCP (peak)	$\leq 11V$			-
					Frequency	DC (0Hz)			-
					Charge current	$\leq 0A$			-
FE	C	Nominal current	E		VL1N	$\leq 10V$		$> 10V$	
					VL1-PE	$\leq 10V$		$> 10V$	
					VN-PE	$\leq 10V$		$> 10V$	
					VCP (peak)	$\leq 11V$			-
					Frequency	DC (0Hz)			-
					Charge current	$\leq 0A$			-



Table 4: List of situations considered in states check

= Test considered positive even if parameter is out of limits

20 Connect the instrument to the adapter as shown in the diagram on the display (input **B4** on input **N**, input **B3** on input **E** and input **B1** on input **L1**).



**Act on the three adapter selectors by setting the followed positions as shown by the instrument by flashing red/blue indications:**

- PP State → **NC**
- CP State → **A**
- Fault → **OK**

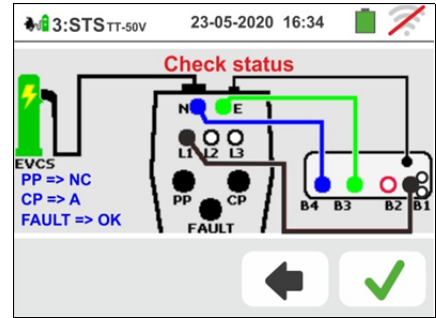
Press the icon  to continue with the test or press the icon  to exit the test and return to the initial screen





21 The result of the measurement is shown in the screen

to the side. The symbol  indicates the correct result of the measurement. The symbol  also indicates a positive result of the measurement but with values outside the limits present in the Table 4.

Press again the **GO/STOP** key to repeat the test

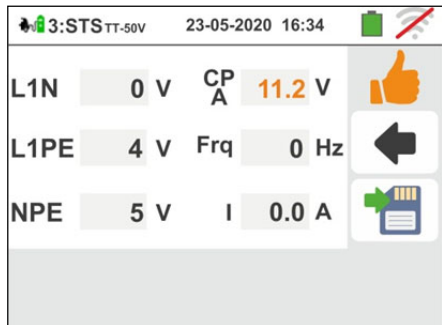
Press the **SAVE** key or touch the  icon for the partial saving of the test and continue with the next test (point 24)



22 If the test fails, the screen like the one on the side is shown on the display. The incorrect value of the parameter is shown in red and the symbol  indicates the non-ok result of the measurement

Press again the **GO/STOP** key to repeat the test

Press the **SAVE** key or touch the icon  for the partial saving of the test and to **end the test sequence**. The instrument shows the message shown in the followed screen for a few seconds

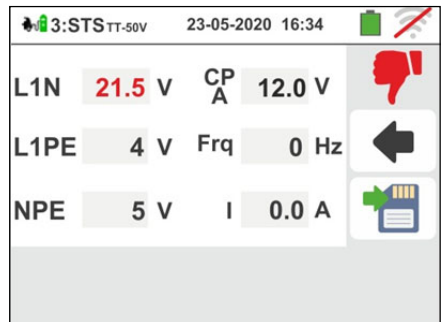

23 Repeat the sequence again if necessary

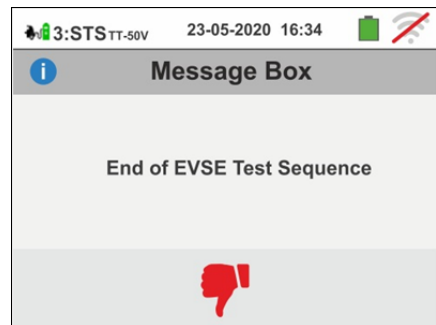



24 Act on the three adapter selectors by setting the following positions as shown by the instrument with flashing red/blue indications:

- PP State → **13A,20A,32A or 63A**
- CP State → **B**
- Fault → **OK**

Try to remove the connection plug of the EV-TEST100 adapter in order to check if the EVSE system **performs the correct locking** as indicated in the screen to the side

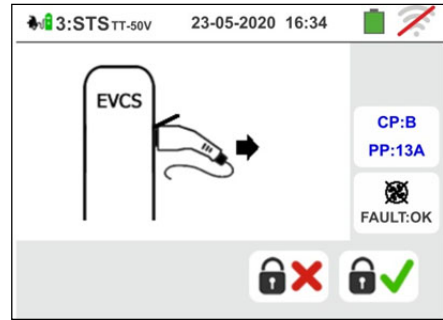

Press the icon if the operation is successful and continue with the next test (point 26) or press the icon

to **end the test sequence**

**NOTE: some EVSE stations could not have the mechanical locking system. In this case, to continue with the tests, select the icon**

25 Repeat the sequence again after restoring normal operation of the EVSE system

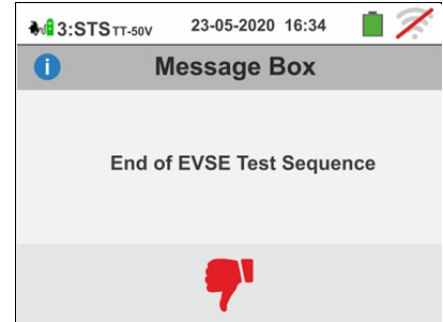

26 Press the icon to activate the **test on B state**. The following screen is shown on the display

Press the icon to exit the test and return to the initial screen

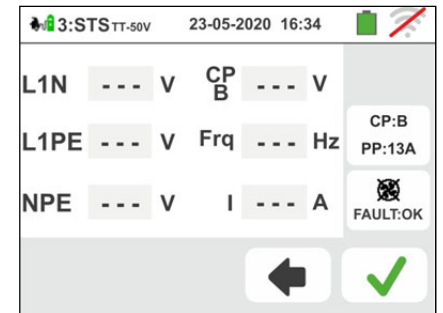

27 The result of the measurement is shown in the screen to the side. The symbol indicates the correct result of the measurement. The symbol also indicates a positive result of the measurement but with values outside the limits present in the Table 4.

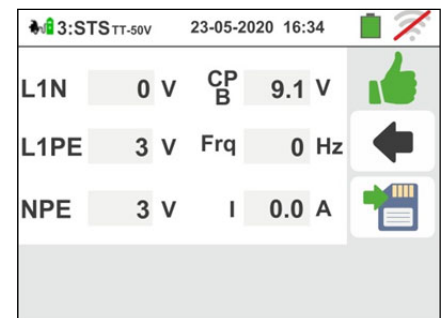

Press the **SAVE** key or touch the icon for the partial saving of the test and continue with the next test (point 30 to check C status or point 34 to check D status)

Press again the **GO/STOP** key to repeat the test

28 If the test fails, the screen like the one on the side is shown on the display. The incorrect value of the parameter is shown in red and the symbol indicates the non-ok result of the measurement.

Press again the **GO/STOP** key to repeat the test

Press the **SAVE** key or touch the icon for the partial saving of the test and to **end the test sequence**. The instrument shows the message shown in the followed screen for a few seconds

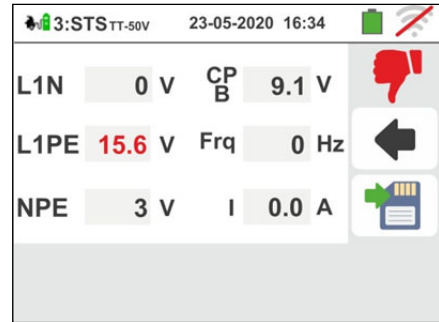

29 Repeat the sequence again if necessary

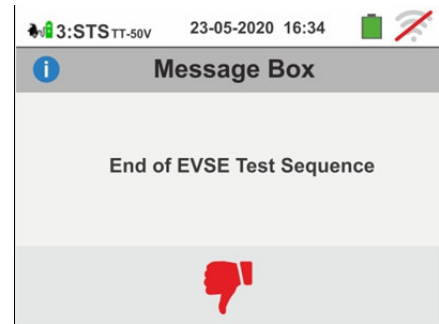

30 **In case of EVSE system in unventilated environment**, act on the three selector switches of the adapter by setting the followed positions as shown by the instrument with flashing red / blue indications

- PP State → **13A,20A,32A or 63A**
- CP State → **C**
- Fault → **OK**

Press the icon to activate the **test on C state**. The following screen is shown on the display

Press the icon to exit the test and return to the initial screen

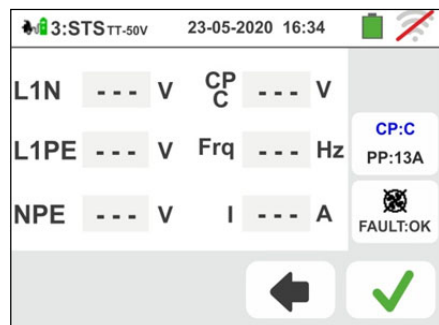

31 The result of the measurement is shown in the screen to the side. The symbol indicates the correct result of the measurement. The symbol also indicates a positive result of the measurement but with values outside the limits present in the Table 4.

Press again the **GO/STOP** key to repeat the test

Press the **SAVE** key or touch the icon for the partial saving of the test and continue with the next test (point 38)

Press again the **GO/STOP** key to repeat the test

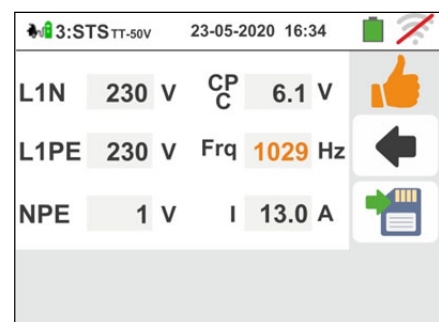

32 If the test fails, the screen like the one on the side is shown on the display. The incorrect value of the parameter is shown in red and the symbol indicates the non-ok result of the measurement.

Press again the **GO/STOP** key to repeat the test

Press the **SAVE** key or touch the icon for the partial saving of the test and to **end the test sequence**. The instrument shows the message shown in the followed screen for a few seconds

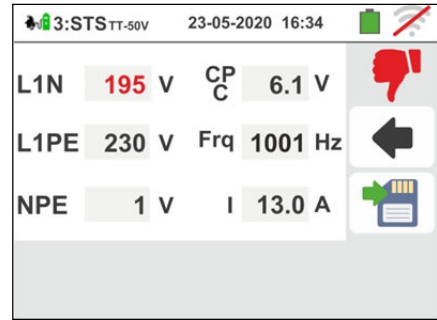

33 Repeat the sequence again if necessary

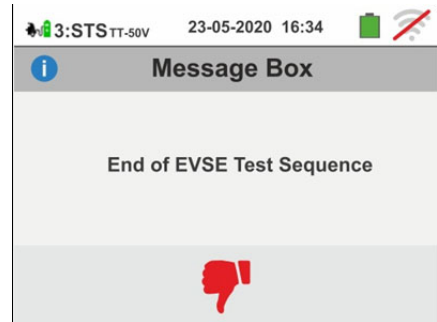

34 **In case of EVSE system in ventilated environment,** act on the three selector switches of the adapter by setting the followed positions as shown by the instrument with flashing red / blue indications:

- PP State → **13A,20A,32A or 63A**
- CP State → **D**
- Fault → **OK**

**NOTE:** the EVSE station should have the possibility to activate manually or automatically the forced ventilation system

Press the icon to activate the **test on D state**. The following screen is shown on the display

Press the icon to exit the test and return to the initial screen

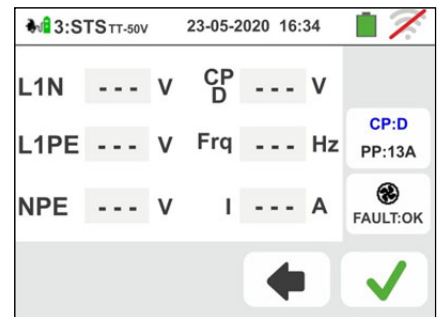

35 The result of the measurement is shown in the screen

to the side. The symbol indicates the correct result of the measurement. The symbol also indicates a positive result of the measurement but with values outside the limits present in the Table 4

Press again the **GO/STOP** key to repeat the test

Press the **SAVE** key or touch the icon for the partial saving of the test and follows with the next test **of PE fault simulation** (point 38)

Press again the **GO/STOP** key to repeat the test

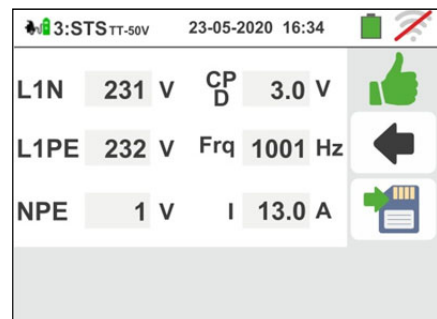

36 If the test fails, the screen like the one on the side is shown on the display. The incorrect value of the parameter is shown in red and the symbol indicates the non-ok result of the measurement.

Press again the **GO/STOP** key to repeat the test

Press the **SAVE** key or touch the icon for the partial saving of the test and to end the test sequence. The instrument shows the message shown in the followed screen for a few seconds

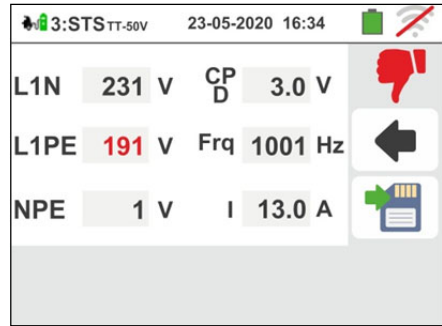

37 Repeat the sequence again if necessary

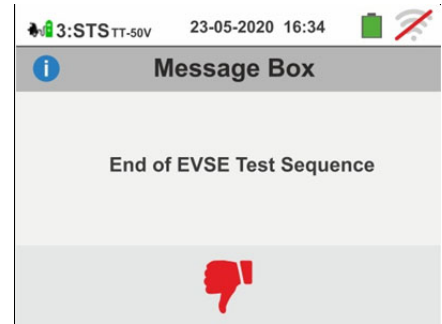

38 Act on the three selector switches of the adapter by setting the followed positions as shown by the instrument with flashing red / blue indications:

- PP State → **13A,20A,32A or 63A**
- CP State → **C**
- Fault → **PE**

Press the icon to activate the test on PE state or press the icon to exit the test and return to the initial screen

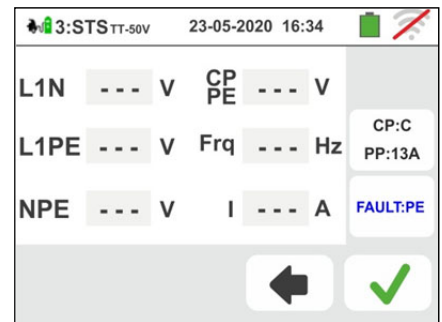

39 The result of the measurement is shown in the screen to the side. The symbol indicates the correct result of the measurement. The symbol also indicates a positive result of the measurement but with values outside the limits present in the Table 4

Press again the **GO/STOP** key to repeat the test

Press the **SAVE** key or touch the icon for the partial saving of the test and follows with the next test of E fault simulation (point 42)

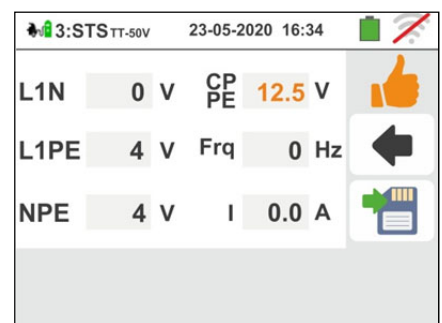

40 If the test fails, the screen like the one on the side is shown on the display. The incorrect value of the parameter is shown in red and the symbol indicates the non-ok result of the measurement.

Press again the **GO/STOP** key to repeat the test

Press the **SAVE** key or touch the icon for the partial saving of the test and to **end the test sequence**. The instrument shows the message shown in the followed screen for a few seconds



41 Repeat the sequence again if necessary

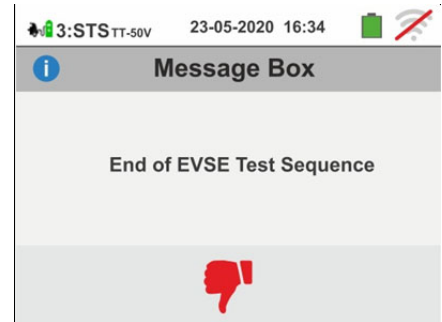

42 Act on the three selector switches of the adapter by setting the followed positions as shown by the instrument with flashing red / blue indications:

- PP State → **13A,20A,32A or 63A**
- CP State → **C**
- Fault → **E**

**NOTE: Some EVSE stations could not manage this error condition. In this case, leave the Fault selector in the PE position to perform the test**

Press the icon to activate the **test on E state** or press the icon to exit the test and return to the initial screen

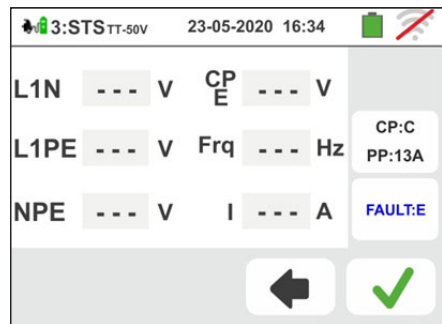

43 The result of the measurement is shown in the screen to the side. The symbol indicates the correct result of the measurement. The symbol also indicates a positive result of the measurement but with values outside the limits present in the Table 4

Press again the **GO/STOP** key to repeat the test

Press the **SAVE** key or touch the icon to end the status control test and save the final result in the instrument's memory (see § 7.1)

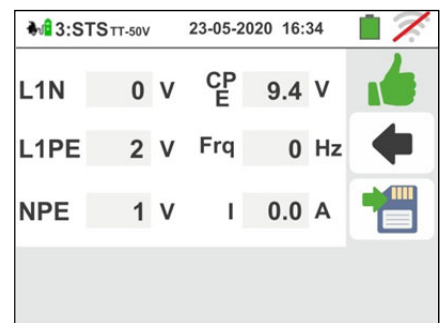

44 If the test fails, the screen like the one on the side is shown on the display. The incorrect value of the parameter is shown in red and the symbol indicates the non-ok result of the measurement.

Press again the **GO/STOP** key to repeat the test

Press the **SAVE** key or touch the icon for the partial saving of the test and to **end the test sequence**. The instrument shows the message shown in the followed screen for a few seconds

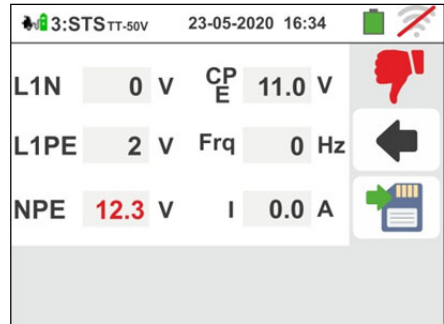

45 Repeat the sequence again if necessary

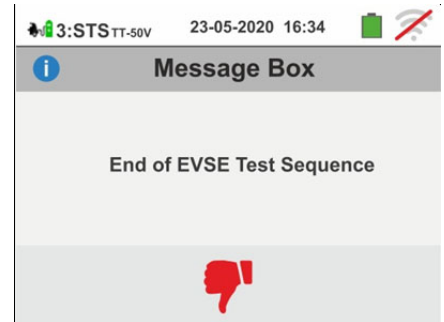

Test 4 → Overall earth resistance measurement of the EVSE system

**TT systems**

46 Connect the instrument to the adapter as shown in the diagram on the display (input **B4** on input **N**, input **B3** on input **E** and input **B1** on input **L1**). **Act on the three adapter selectors by setting the followed positions as shown by the instrument by flashing red/blue indications:**

- PP State → **13A,20A,32A or 63A**
- CP State → **C**
- Fault → **OK**

Press the icon to continue with the test or press the icon to exit the test and return to the initial screen

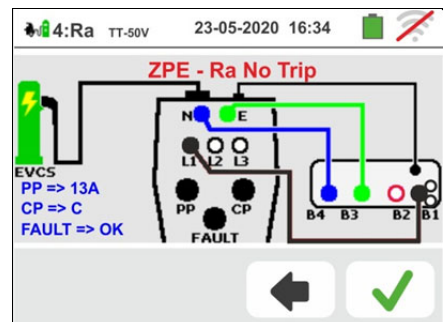

47 The test is performed by the instrument **only in "NoTrip" mode**. Refer to § 6.4.12 for the description on the setting of the test parameters relative to the trip out current of the RCD, **absence of neutral conductor (only possible measurement)** and the preliminary calibration of the measuring terminals

Press the **GO/STOP key for a few seconds**. The followed screen is shown on the display

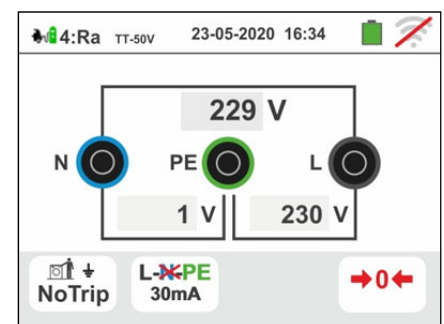



48 During this whole phase, do not disconnect the measuring terminals of the instrument from the system on test. In case of positive outcome (global earth resistance lower than the ratio between the limit contact voltage and the RCD tripping current - see § 13.8), the screen to the side is shown by the instrument in which the contact voltage value is indicated on the secondary display.

Press again the **GO/STOP** key for a few seconds to repeat the test

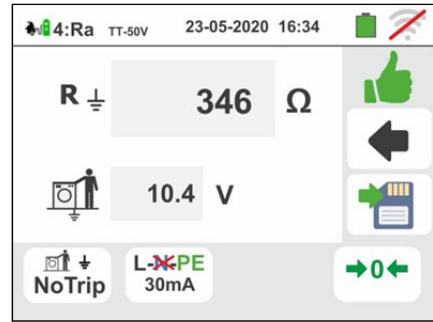

Press the **SAVE** key or touch the icon  for the partial saving of the test and follows with the next test (point 55)

49 In case of negative outcome (global earth resistance higher than the ratio between the limit contact voltage and the RCD tripping current - see § 13.8), the screen to the side is shown by the instrument in which the contact voltage value is indicated on the secondary display. Note the presence of the result of the contact voltage measurement highlighted in red.

Press again the **GO/STOP** key for a few seconds to repeat the test

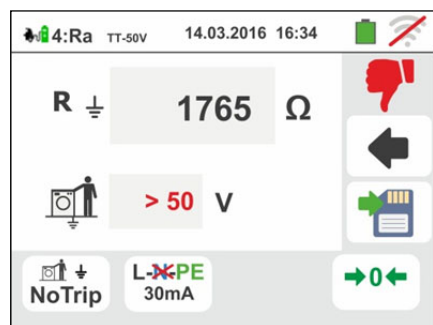

Press the **SAVE** key or touch the icon  for the partial saving of the test and to end the test sequence. The instrument shows the message shown in the followed screen for a few seconds

50 Repeat the sequence again if necessary

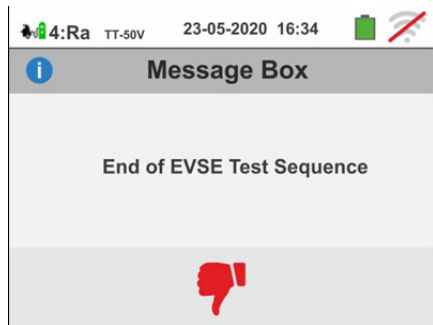

### TN systems

51 The test is performed by the instrument only in "NoTrip" mode, with RCD tripping current fixed to 6mA (MCB and FUSE options are blocked). Refer to § 6.4.2 the preliminary calibration of the terminals of measurement

Press the GO/STOP key for a few seconds. The followed screen is shown on the display

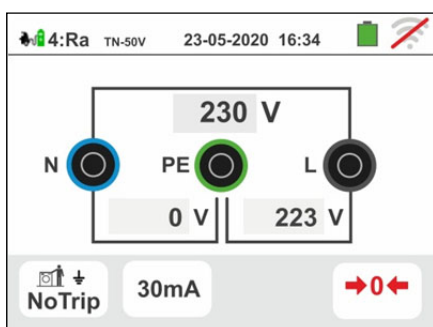

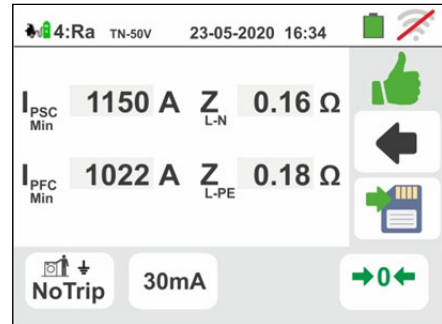

52 During this whole phase, do not disconnect the measuring terminals of the instrument from the system. In case of positive result ( $Z_{L-PE}$  or  $Z_{L-N}$  **LOWER** or **EQUAL** to limit impedance relative to protection device within the specified time – see § 13.7), the screen to the side is displayed by the instrument. Press again the **GO/STOP** key for a few seconds to repeat the test

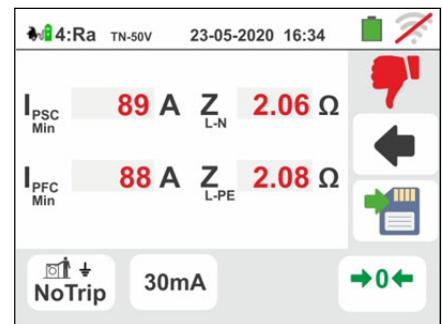

Press the **SAVE** key or touch the icon  for the partial saving of the test and follows with the next test (point 55)

53 In case of negative result ( $Z_{L-PE}$  or  $Z_{L-N}$  **HIGHER** to limit impedance relative to protection device within the specified time – see § 13.7), the screen to the side is displayed by the instrument. Note the presence of the result of the measurement highlighted in red. Press again the **GO/STOP** key for a few seconds to repeat the test



Press the **SAVE** key or touch the icon  for the partial saving of the test and to end the test sequence. The instrument shows the message shown in the followed screen for a few seconds

54 Repeat the sequence again if necessary

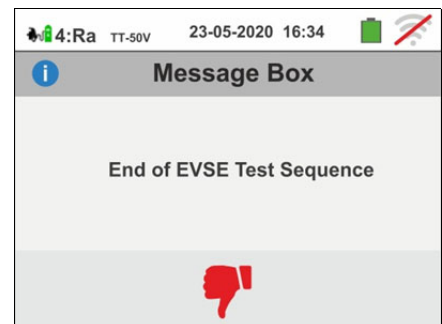

### Test 5 → Test of RCD type A of EVSE system

55 Connect the instrument to the adapter as shown in the diagram on the display (input **B4** on input **N**, input **B3** on input **E** and input **B1** on input **L1**). **Act on the three adapter selectors by setting the followed positions as shown by the instrument by flashing red/blue indications:**

- PP State → **13A, 20A, 32A or 63A**
- CP State → **C**
- Fault → **OK**

Press the icon to continue with the test or press the icon to exit the test and return to the initial screen

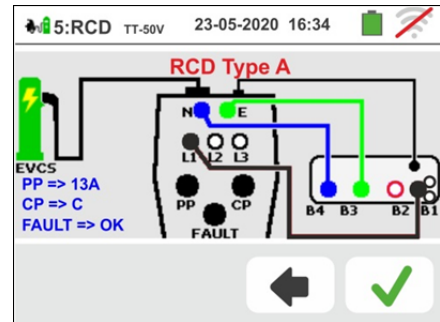

56 The test is performed by the instrument considering **only General RCD of STD (G) type, type A and in Ramp mode ( ) 0°**. Touch the second icon. The followed screen is shown on the display

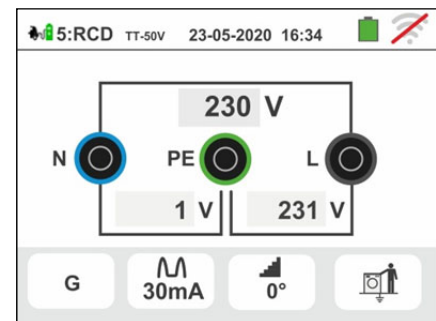

57 Move the third slide bar reference by selecting the desired rated current of the differential switch between the options: **6, 10, 30, 100, 300, 500, 650mA**

Press the icon to continue with the test or press the icon to exit the test and return to the previous screen. Touch the third icon. The followed screen is shown on the display

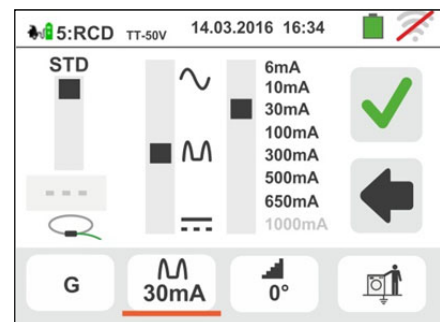

58 **Ramp mode is fixed on the instrument.** Move the reference of the lower sliding bar by selecting the type of display of the tripping current during the ramp test between the "**NOM**" or "**REAL**" options (see § 6.3)

Press the icon to continue with the test or press the icon to exit the test and return to the previous screen.

Press the **GO/STOP key for a few seconds**. The followed screen is shown on the display

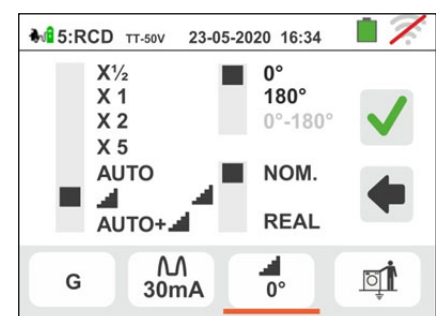

59 During this whole phase, do not disconnect the measuring terminals of the instrument from the system. At the end of the test, if the tripping current is within the values of the table in the relevant § 11.1 the instrument

displays the  symbol to indicate the positive outcome of the test and displays a screen like the one to the side.

Press again the **GO/STOP** key for a few seconds to repeat the test

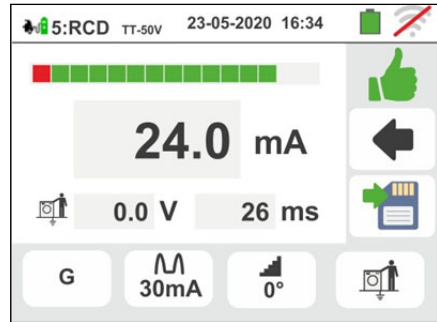



Press the **SAVE** key or touch the icon  for the partial saving of the test. The instrument shows the message shown in the followed screen for a few seconds

60 Restore the EVSE system as follows:

- Move CP State selector → **A**
- Move CP State selector → **C**
- If the RCD trip-out reset it

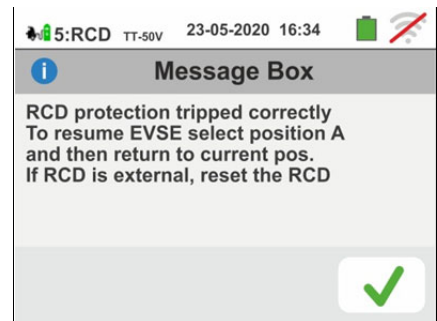
Press the icon  to continue with the next test (point 63)



61 At the end of the test, if the tripping current is not within the values of the table in the relevant § 11.1, the instrument displays the  symbol to indicate the negative outcome of the test and displays a screen like the one to the side.

Press again the **GO/STOP** key for a few seconds to repeat the test

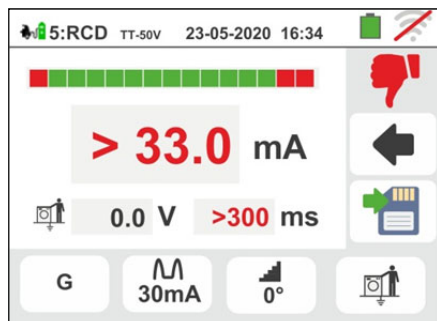

Press the **SAVE** key or touch the icon  for the partial saving of the test and to end the test sequence. The instrument shows the message shown in the followed screen for a few seconds

62 Repeat the sequence again if necessary

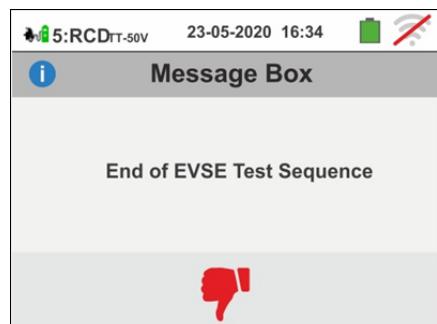

Test 6 → Test of RCD type B of EVSE system

63 Connect the instrument to the adapter as shown in the diagram on the display (input **B4** on input **N**, input **B3** on input **E** and input **B1** on input **L1**). **Act on the three adapter selectors by setting the followed positions as shown by the instrument by flashing red/blue indications:**

- PP State → **13A, 20A, 32A or 63A**
- CP State → **C**
- Fault → **OK**

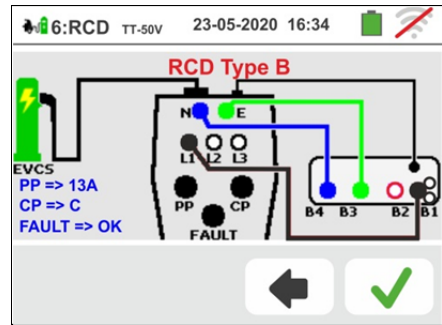

Press the icon to continue with the test or press the icon to exit the test and return to the main screen

64 The test is performed by the instrument considering **only General RCD of STD (G) type, type B and in Ramp mode ( ) 0°**. Touch the second icon. The followed screen is shown on the display

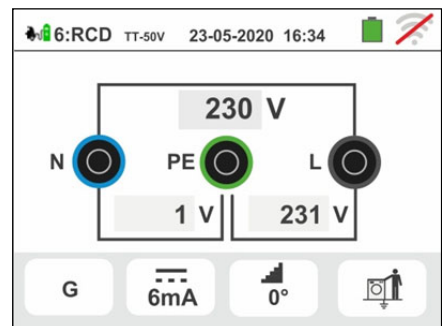

65 Move the second slide bar reference by selecting the waveform of the differential switch between the options: (type AC), (type A), (type B). Move the third slide bar reference by selecting the desired rated current of the differential switch between the options: **6, 10, 30, 100, 300mA**

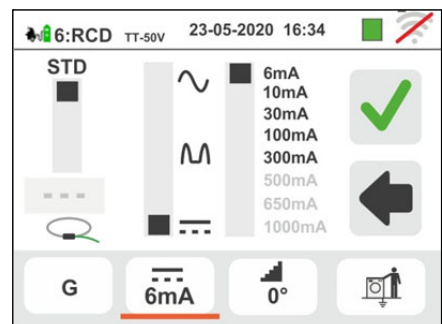

Press the icon to continue with the test or press the icon to exit the test and return to the previous screen. Touch the third icon. The followed screen is shown on the display

66 **Ramp mode is fixed on the instrument.** Move the reference of the lower sliding bar by selecting the type of display of the tripping current during the ramp test between the "**NOM**" or "**REAL**" options (see § 6.3).

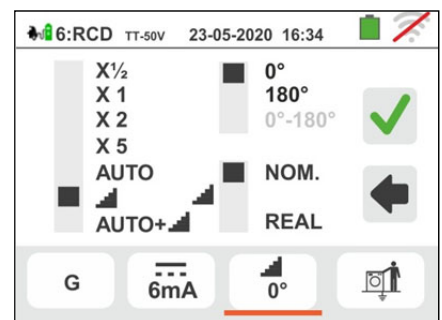



Press the icon to continue with the test or press the icon to exit the test and return to the previous screen.

Press the **GO/STOP key for a few seconds**. The followed screen is shown on the display

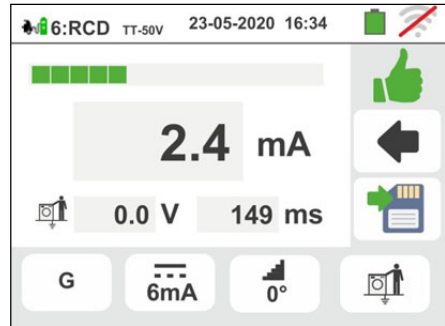
67 During this whole phase, do not disconnect the measuring terminals of the instrument from the system. At the end of the test, if the tripping current is within the values of the table in the relevant § 11.1 the instrument displays the  symbol to indicate the positive outcome of the test and displays a screen like the one to the side. Press again the **GO/STOP** key for a few seconds to repeat the test



Press the **SAVE** key or touch the icon  for the final saving of the test on EVSE system (see § 7.1)

68 At the end of the test, if the tripping current is not within the values of the table in the relevant § 11.1, the instrument displays the  symbol to indicate the negative outcome of the test and displays a screen like the one to the side. Press again the **GO/STOP** key for a few seconds to repeat the test

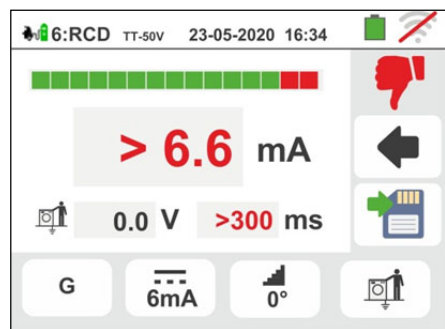

Press the **SAVE** key or touch the icon  for the partial saving of the test and to end the test sequence. The instrument shows the message shown in the followed screen for a few seconds

69 Repeat the sequence again if necessary

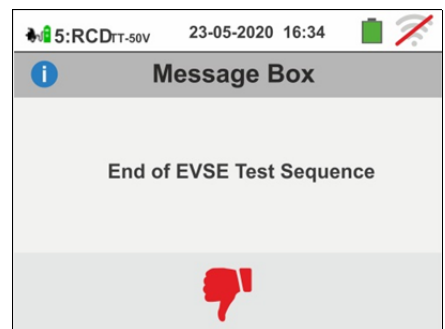



## 7. OPERATIONS WITH THE MEMORY





### 7.1. SAVING MEASUREMENTS

The structure of the memory area (999 locations), of "tree" type with the possibility to expand/hide the nodes, allows the division up to 3 markers nested so as to finalize the precise locations of the measuring points with the insertion of test results. Each marker has associated up to **20 fixed names (non-editable or deletable)** + max 20 names that can be freely defined by the user on the instrument or by means of management software (see the online help of the program). For each marker, it is also possible to associate a number between 1 and 250.



1. At the end of each measurement, press the **SAVE** key

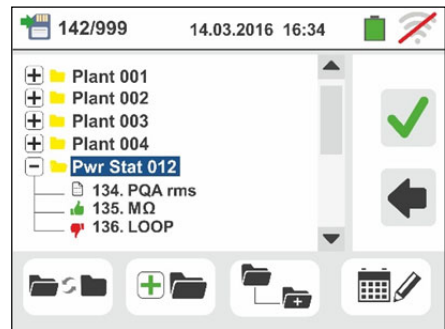

or touch the  icon to save its result. The screen to the side appears on the display.

The meaning of the icons is the following:

-  → It expands/hides the selected node
-  → It allows the choice of a 1<sup>st</sup> level node
-  → It inserts a nested sub-node (max 3 levels)
-  → It adds a user comment on the performed measurement. This comment is visible both after downloading the saved data to the PC with the management software (see § 8) and during the recalling of the result at display (see § 7.2)



2. Press the  or  key to insert a main marker or a sub-marker. The screen to the side is shown by the instrument. Touch one of the names on the list this to select the desired marker among the fixed ones or one of the 20 markers indicated as "L1\_FREE0x" whose name can be customized by the user. Touch the arrow

keys  or  to enter a number associated with the marker, if needed. Confirm the choices by returning to

the main screen. Touch the  key. The following screen appears on the display:

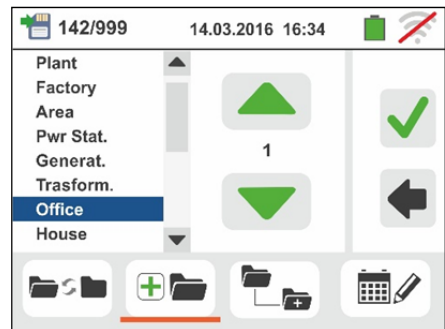

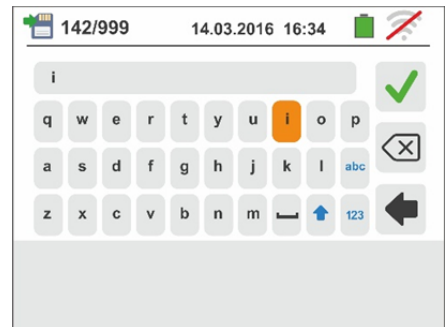

3. Use the virtual keyboard in order to define the customized name of the "L1\_FREE0x" which can be modified at any time by the user during a saving operation. marker enter any comment on the measurement. **This marker cannot be deleted but only renamed.**

Confirm the choices by returning to the main screen.





Further confirm to permanently save the measurement in the internal memory. A confirmation message is provided by the instrument.

## 7.2. RECALLING MEASUREMENTS AND DELETING THE MEMORY

1. Touch the  icon in the general menu. The screen to the side appears on the display. Each measurement is identified by the icons  (test with positive result) or  (test with negative result). Touch the desired measurement to select it on the display.

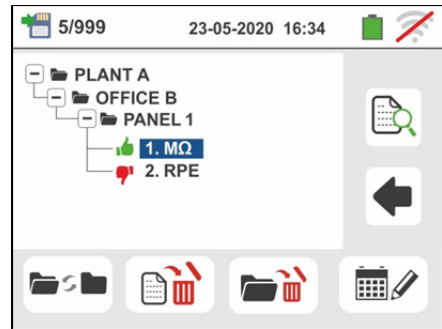
Touch the  icon to recall the measurement result. The following screen appears on the display:



2. Touch the  icon to recall and possibly change the comment entered when saving via the internal virtual keyboard.

Touch the  icon to go back to the previous screen.

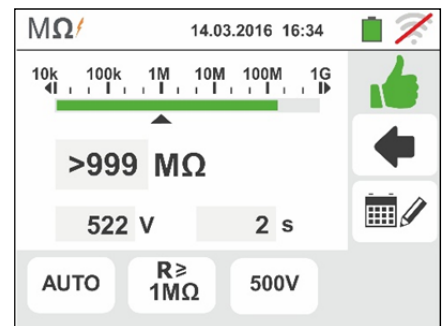



3. Touch the  icon to recall and possibly change the comment entered when saving **test on EVSE system** via the internal virtual keyboard.

Touch the  icon to go back to the previous screen.

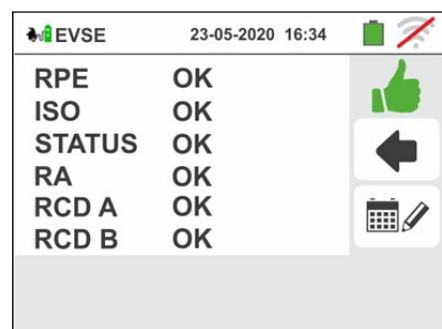
**NOTE: it is not possible to review the detail of the individual measurements on the display but only the result of the partial test**



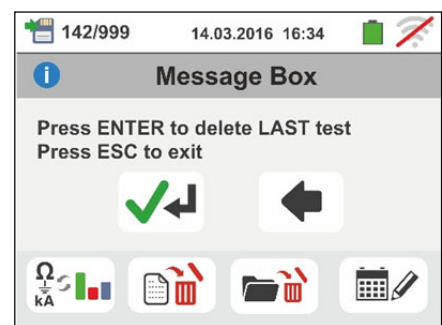

4. Touch the  icon to delete **the last saved result in the instrument memory**. The following screen appears on the display:

Touch the  icon to confirm the operation or the  icon to return to the previous screen.



5. Touch the  icon to delete **all the results stored in the memory of the instrument**. The following screen appears on the display:

Touch the  icon to confirm the operation or the  icon to return to the previous screen.

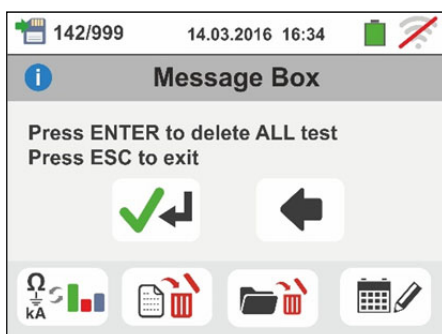

### 7.2.1. Anomalous situations

1. In case there is no measure saved and the instrument memory is accessed, a screen similar to the one reported here to the side is displayed.



2. In case tries to define a new sub-node over the 3rd level the instrument provides the warning screen shown to the side and blocks the operation

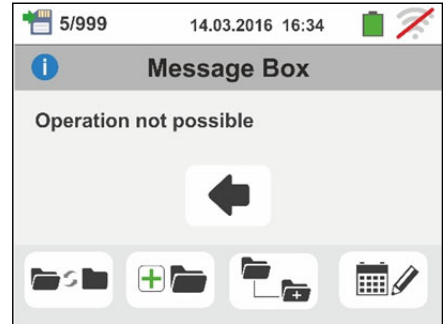

3. In case tries to create a sub-node by using a just used name, the instrument provides the warning screen shown to the side and is necessary to define a new name



4. In case tries to define a numebr of nodes of 1st, 2nd and 3rd level higher than 250 (for each level), the instrument provides the warning screen shown to the side

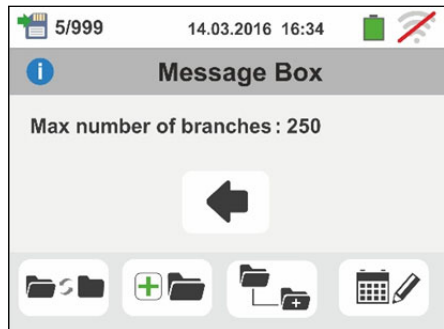

5. In case tries to include a comment of length higher than 30 chars, the instrument provides the warning screen shown to the side

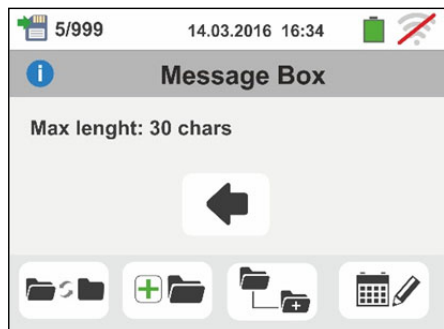



## 8. CONNECTING THE INSTRUMENT TO A PC OR MOBILE DEVICES

The connection between a PC and the instrument can be done via a serial port (see Fig. 3) by means of an optical cable/USB C2006 or by means a WiFi connection. Before making the connection in USB mode, it is **necessary** to install on the PC the C2006 cable drivers present in the supplied CD-ROM in addition to the management software. To transfer stored data to PC keep to the following procedure:

### Connection to PC via optical/USB cable

1. Switch on the instrument by pressing the **ON/OFF** key.
2. Connect the instrument to the PC via the optical cable/USB.

3. Touch the  icon in the general menu. The screen to the side is shown by the instrument. Disable the WiFi connection touch the icon in the top right side of the display. The symbol “” appear at display.

In these conditions, the instrument is able to communicate with the PC via USB port

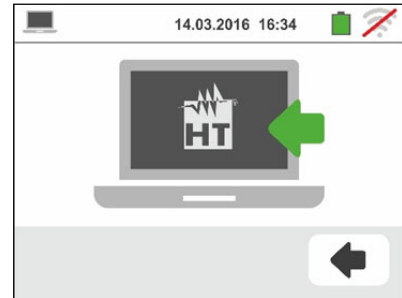

4. Use the management software to download the instrument memory contents to a PC. Please refer to the online help of the program itself for any detail regarding the operation.
5. Touch the  icon to go back to the general menu of the instrument.

### Connecting to a PC through WiFi

1. Enable the WiFi connection on the target PC (ex: by using a WiFi key installed and connected to a USB port)
2. Put the instrument in data transfer mode to a PC (see § 8 - point 3). Enable the WiFi connection touch the icon in the top right side of the display. The symbol “” appear at display

In these conditions, the instrument is able to communicate with the PC via WiFi connection



3. Launch the management software, select the "WiFi" port and "Detect instrument" within the section "PC-Instrument connection"
4. Use the management software to download the instrument memory contents to a PC. Please refer to the online help of the program itself for any detail regarding the operation.

### 8.1. CONNECTION TO IOS/ANDROID DEVICES THROUGH WIFI

The instrument can be connected remotely via WiFi connection to a Android/iOS smartphones and/or tablets for the transfer of measurement data using the APP **HTAnalysis**. Proceed as follows:

1. Download and install the HTAnalysis on the desired remote device (Android/iOS) (see § 5.1.7)
2. Put the instrument in data transfer mode to a PC (see § 8 - point 3).
3. Take reference to the HTAnalysis instruction for the management operation

## 9. USE OF STRAP SET

It is possible to use a strap set (SP-0500 optional accessory) which allows the operator to carry the instrument on his shoulder. The strap set (see Fig.38) is composed of the following parts:



### CAPTION

1. Half-shells with holes for hooks to be inserted in the instrument
2. Hooks for insertion inside the half-shells
3. Shoulder strap with snap-hooks
4. Strap with snap-hooks to fix the instrument to the operator's body

Fig. 39: Strap set parts

How to assemble the parts:

1. Remove the half-shells from the instrument by levering the upper parts and pulling outwards (see Fig.39)



Fig. 40: Remove lateral half-shells

2. Mount the 4 hooks (see Fig.38 - part 2) inside the slots on the half-shells of the strap set as shown in Fig.40. Push each hook fully into the slot until it is completely tightened (click)





Fig. 41: Mounting hooks to fix straps

3. The instrument with the fitted half-shells and hooks must be as shown in Fig. 41



Fig. 42: Instrument with fitted half-shells and hooks



4. Connect the snap-hooks of the shoulder strap (see Fig. 38 - part 3) to the two hooks on the top of the instrument, adjusting the inner part which surrounds the operator's neck (see Fig. 42)



Fig. 43: Complete mounting of set strap

5. Connect the snap-hooks of the strap for fixing the instrument to the operator's body (see Fig.38 – part 4) to the two hooks at the bottom of the instrument, and adjust the strap to keep the instrument horizontal to the operator (see Fig. 42)

## 10. MAINTENANCE

### 10.1. GENERAL INFORMATION

- While using and storing the instrument, carefully observe the recommendations listed in this manual in order to prevent possible damage or danger during use.
- Do not use the instrument in environments with high humidity levels or high temperatures. Do not expose to direct sunlight.
- Always switch off the instrument after use. Should the instrument remain unused for a long time, remove the batteries to avoid liquid leaks that could damage the instruments internal circuits.

### 10.2. REPLACEMENT OF THE BATTERIES

When the LCD display shows the low battery symbol , replace the alkaline batteries or recharge the rechargeable batteries.

#### CAUTION



Only expert and trained technicians should perform this operation. Before carrying out this operation, make sure you have disconnected all cables from the input terminals.

1. Switch off the instrument by pressing the **ON/OFF** key.
2. Remove the cables from the input leads
3. Loosen the battery compartment cover fastening screw and remove the cover.
4. Remove all the batteries from the battery compartment and replace them with new batteries of the right type only (§ 11.3) making sure to respect the indicated polarities. To recharge the batteries, use the external battery charger (see § 11.5)
5. Restore the battery compartment cover into place and fasten it by mean of the relevant screw.
6. Do not scatter old batteries into the environment. Use the relevant containers for disposal.

### 10.3. CLEANING THE INSTRUMENT

Use a soft and dry cloth to clean the instrument. Never use wet cloths, solvents, water, etc.

### 10.4. END OF LIFE



**CAUTION:** the symbol on the instrument indicates that the appliance and its accessories must be collected separately and correctly disposed of.

## 11. TECHNICAL SPECIFICATIONS

Accuracy is calculated as:  $\pm[\% \text{reading} + (\text{no. of digits}) * \text{resolution}]$  at 23°C, <80%RH. Refer to the Table 1 for the correspondence between models and available features

### 11.1. TECHNICAL CHARACTERISTICS

#### AC TRMS voltage

Range [V]	Resolution [V]	Accuracy
15 ÷ 460	1	$\pm(3\% \text{rdg} + 2 \text{digits})$

#### Frequency

Range [Hz]	Resolution [Hz]	Accuracy
47.0 ÷ 63.6	0.1	$\pm(0.1\% \text{reading} + 1 \text{digit})$

#### Continuity of protective conductor (RPE)

Range [ $\Omega$ ]	Resolution [ $\Omega$ ]	Accuracy (*)
0.01 ÷ 99.99	0.01	$\pm(5.0\% \text{reading} + 3 \text{digits})$
100 ÷ 1999	1	$\pm(10.0\% \text{rdg} + 5 \text{digits})$

(\*) after calibration of measuring cables

Test current: >200mA DC up to 2 $\Omega$  (cables included) ; Test current resolution: 1mA ; Open-circuit voltage:  $4 < V_0 < 24V$

#### Insulation resistance (M $\Omega$ )

Test voltage [V]	Range [M $\Omega$ ]	Resolution [M $\Omega$ ]	Accuracy
50	0.01 ÷ 9.99	0.01	$\pm(2.0\% \text{reading} + 2 \text{digits})$
	10.0 ÷ 49.9	0.1	$\pm(5.0\% \text{reading} + 2 \text{digits})$
	50.0 ÷ 99.9		
100	0.01 ÷ 9.99	0.01	$\pm(2.0\% \text{reading} + 2 \text{digits})$
	10.0 ÷ 99.9	0.1	$\pm(5.0\% \text{reading} + 2 \text{digits})$
	100.0 ÷ 199.9		
250	0.01 ÷ 9.99	0.01	$\pm(2.0\% \text{reading} + 2 \text{digits})$
	10.0 ÷ 99.9	0.1	$\pm(5.0\% \text{reading} + 2 \text{digits})$
	100 ÷ 499		
500	0.01 ÷ 9.99	0.01	$\pm(2.0\% \text{reading} + 2 \text{digits})$
	10.0 ÷ 199.9	0.1	
	200 ÷ 499	1	$\pm(5.0\% \text{reading} + 2 \text{digits})$
	500 ÷ 999		
1000	0.01 ÷ 9.99	0.01	$\pm(2.0\% \text{reading} + 2 \text{digits})$
	10.0 ÷ 199.9	0.1	
	200 ÷ 999	1	$\pm(5.0\% \text{reading} + 2 \text{digits})$
	1000 ÷ 1999		

Open-circuit voltage

rated test voltage -0% +10%

Rated measuring current:

>1mA with 1k $\Omega$  x Vnom (50V, 100V, 250V, 1000V), >2.2mA with 230k $\Omega$  @ 500V

Short-circuit current

<6.0mA for each test voltage

Safety protection:

error message for input voltage > 10V

#### Line/Loop impedance (Phase-Phase, Phase-Neutral, Phase-Earth)

Range [ $\Omega$ ]	Resolution [ $\Omega$ ]	Accuracy (*)
0.01 ÷ 9.99	0.01	$\pm(5\% \text{rdg} + 3 \text{digits})$
10.0 ÷ 199.9	0.1	

(\*) 0.1 m $\Omega$  in range 0.1 ÷ 199.9 m $\Omega$  (by using the optional accessory IMP57)

Maximum test current: 5.81A (at 265V); 10.10A (at 457V)

Phase-Neutral/Phase-Phase Test voltage: (100V ÷ 265V) / (100V ÷ 460V); 50/60Hz  $\pm 5\%$

Protection types: MCB (B, C, D, K), Fuse (aM, gG, BS882-2, BS88-3, BS3036, BS1362)

Insulating sheath materials: PVC, Butyl rubber, EPR, XLPE

#### First fault current – IT systems

Range [mA]	Resolution [mA]	Accuracy
0.1 ÷ 0.9	0.1	$\pm(5\% \text{reading} + 1 \text{digit})$
1 ÷ 999	1	$\pm(5\% \text{reading} + 3 \text{digits})$

Limit contact voltage (ULIM) : 25V, 50V

**Test on RCD protection (Molded case type)**

Differential protection type (RCD): AC (☑), A (☑), B (☑) – General (G), Selective (S) and Delayed (☑)

Voltage range Phase-Earth, Phase-Neutral: 100V ±265V RCD type AC and A, 190V ±265V RCD type B

 Rated tripping currents (I<sub>ΔN</sub>): 6mA, 10mA, 30mA, 100mA, 300mA, 500mA, 650mA, 1000mA

Frequency: 50/60Hz ± 5%

**Molded case type RCD tripping current - (for General RCD only)**

RCD type	I <sub>ΔN</sub>	Range I <sub>ΔN</sub> [mA]	Resolution [mA]	Accuracy
AC, A, B	6mA, 10mA	(0.2 ÷ 1.1) I <sub>ΔN</sub>	≤ 0.1 I <sub>ΔN</sub>	- 0%, +10% I <sub>ΔN</sub>
AC, A, B	30mA ≤ I <sub>ΔN</sub> ≤ 300mA			- 0%, +5% I <sub>ΔN</sub>
AC, A	500mA ≤ I <sub>ΔN</sub> ≤ 650mA			

**Measurement duration of Molded case type RCD tripping time – TT/TN systems**

	x 1/2			x 1			x 2			x 5			AUTO						AUTO+			
	\	G	S	☑	G	S	☑	G	S	☑	G	S	☑	G	S	☑	G	S	☑	G	S	☑
6mA	AC	999	999	999	999	999	999	160	210		50	150		✓	✓		310			✓		
	A	999	999	999	999	999	999	160	210		50	150		✓	✓		310			✓		
	B	999	999	999	999	999	999										310					
10mA	AC	999	999	999	999	999	999	160	210		50	150		✓	✓		310			✓		
	A	999	999	999	999	999	999	160	210		50	150		✓	✓		310			✓		
	B	999	999	999	999	999	999										310					
30mA	AC	999	999	999	999	999	999	160	210		50	150		✓	✓		310			✓		
	A	999	999	999	999	999	999	160	210		50	150		✓	✓		310			✓		
	B	999	999	999	999	999	999										310					
100mA	AC	999	999	999	999	999	999	160	210		50	150		✓	✓		310					
	A	999	999	999	999	999	999	160	210		50	150		✓	✓		310					
	B	999	999	999	999	999	999										310					
300mA	AC	999	999	999	999	999	999	160	210		50	150		✓	✓		310					
	A	999	999	999	999	999	999	160	210		50	150		✓	✓		310					
	B	999	999	999	999	999	999										310					
500mA 650mA	AC	999	999	999	999	999	999	160	210		50	150		✓	✓		310					
	A	999	999	999	999	999	999	160	210								310					
	B																					
1000mA	AC	999	999	999	999	999	999	160	210													
	A	999	999	999	999	999	999															
	B																					

Table with duration of tripping time measurement [ms] - Resolution: 1ms, Accuracy: ±(2.0%reading + 2digits)

**Measurement duration of Molded case type RCD tripping time – IT systems (\*)**

	x 1/2			x 1			x 2			x 5			AUTO						AUTO+			
	\	G	S	☑	G	S	☑	G	S	☑	G	S	☑	G	S	☑	G	S	☑	G	S	☑
6mA 10mA 30mA	AC	999	999	999	999	999	999	160	210		50	150		✓	✓		310			✓		
	A	999	999	999	999	999	999	160	210		50	150		✓	✓		310			✓		
	B	999	999			999	999											310			✓	
100mA 300mA	AC	999	999	999	999	999	999	160	210		50	150		✓	✓		310					
	A	999	999	999	999	999	999	160	210		50	150		✓	✓		310					
	B	999	999			999	999															
500mA 650mA	AC	999	999	999	999	999	999	160	210		50	150		✓								
	A	999	999	999	999	999	999	160	210					✓								
	B																					
1000mA	AC	999	999		999	999		160	210													
	A	999	999		999	999																
	B																					

Table with duration of tripping time measurement [ms] - Resolution: 1ms, Accuracy: ±(2.0%reading + 2digits)

(\*) Selection RCD type A and B only available for Norway country

**Test on RCD without integral current breaking device (with accessory RCDX10)**

Differential protection type (RCD): AC (⚡), A (⚡), B (⚡) – Generali (G), Selettivi (S) e Ritardati (⌚)  
 Voltage range Phase-Earth, Phase-Neutral: 100V ÷ 265V RCD type AC and A, 190V ÷ 265V RCD type B  
 Rated tripping currents (I<sub>ΔN</sub>): 0.3A ÷ 10A  
 Frequency: 50/60Hz ± 5%

**RCD without integral current breaking device tripping current - (for General RCD only)**

RCD type	I <sub>ΔN</sub>	Range I <sub>ΔN</sub> [mA]	Resolution [mA]	Accuracy
AC, A, B	300mA ≤ I <sub>ΔN</sub> ≤ 1A	(0.3 ÷ 1.1) I <sub>ΔN</sub>	≤ 0.1 I <sub>ΔN</sub>	- 0%, +5% I <sub>ΔN</sub>
AC, A	1.1A ≤ I <sub>ΔN</sub> ≤ 10A			

**Duration of RCD without integral current breaking device tripping time – TT/TN systems**

	\	x 1/2			x 1			x 2		x 5		AUTO					
		G	S	⌚	G	S	⌚	G	S	⌚	G	S	⌚	G	S	⌚	
0.3A ÷ 1.0A	AC	999	999	999	999	999	999	200	250	50	150	✓	✓			310	
	A	999	999	999	999	999	999	200	250	50	150	✓	✓			310	
	B	999	999	999	999	999	999									310	
1.1A ÷ 3.0A	AC	999	999	999	999	999	999	200	250	50	150	✓	✓			310	
	A	999	999	999	999	999	999	200	250	50	150	✓	✓			310	
	B	999	999	999	999	999	999										
3.1A ÷ 6.5A	AC	999	999	999	999	999	999	200	250	50	150	✓	✓			310	
	A	999	999	999	999	999	999	200	250	50	150	✓	✓			310	
	B	999	999	999	999	999	999										
6.6A ÷ 10.0A	AC	999	999	999	999	999	999	200	250								
	A	999	999	999	999	999	999										
	B																

Table with duration of tripping time measurement [ms] - Resolution: 1ms, Accuracy: ±(2.0%reading + 2digits)

**Duration of RCD without integral current breaking device tripping time – IT systems (\*)**

	\	x 1/2			x 1			x 2		x 5		AUTO					
		G	S	⌚	G	S	⌚	G	S	⌚	G	S	⌚	G	S	⌚	
0.3A ÷ 3.0A	AC	999	999	999	999	999	999	200	250	50	150	✓	✓			310	
	A	999	999	999	999	999	999	200	250	50	150	✓	✓				
	B																
3.1A ÷ 6.5A	AC	999	999	999	999	999	999	200	250	50	150	✓	✓			310	
	A	999	999	999	999	999	999	200	250	50	150	✓	✓				
	B																
6.6A ÷ 10.0A	AC	999	999	999	999	999	999	200	250								
	A	999	999	999	999	999	999	200	250								
	B																

Table with duration of tripping time measurement [ms] - Resolution: 1ms, Accuracy: ±(2.0%reading + 2digits)

(\*) Selection RCD type A only available for Norway country

**Overall earth resistance without RCD tripping (NoTrip )**

Voltage range Phase-Earth, Phase-Neutral: 100 ÷ 265V, Frequency: 50/60Hz ± 5%

**Global earth resistance in systems with Neutral**

Range [Ω]	Resolution [Ω]	Accuracy (*)
0.01 ÷ 9.99	0.01	-±(5%rdg + N/10)
10.0 ÷ 199.9	0.1	-±(5%rdg + N)
200 ÷ 1999	1	-±(5%rdg + 3N)

(\*) If I<sub>ΔN</sub> < 30mA, test current = I<sub>ΔN</sub>/2 and N[Ω]=30/I<sub>ΔN</sub>; if I<sub>ΔN</sub> ≥ 30mA, test current < 15mA and N=1Ω

**Global earth resistance in systems without Neutral**

Range [Ω]	Resolution [Ω]	Accuracy
1 ÷ 1999	1	-±(5%rdg + N)

(\*) if I<sub>ΔN</sub> < 30mA, test current = I<sub>ΔN</sub>/2 and N[Ω]=(10x30)/I<sub>ΔN</sub> Ω; if I<sub>ΔN</sub> ≥ 30mA, test current I<sub>ΔN</sub>/2 and N[Ω]=(3x30)/I<sub>ΔN</sub>

**Contact voltage (measured during RCD and NoTrip $\frac{1}{T}$  test)**

Range [V]	Resolution [V]	Accuracy
0 ÷ Ut LIM	0.1	-0%, +(5.0% rdg + 3V)

**Contact voltage (EARTH test – TT systems)**

Range [V]	Resolution [V]	Accuracy
0 ÷ 99.9	0.1	-0%, +(5.0% lettura + 3V)

**Contact voltage (EARTH test – TN systems)**

Range [V]	Resolution [V]	Accuracy
0 ÷ 99.9	0.1	-0%, +(5.0% rdg + 3V)
100 ÷ 999	1	-0%, +(5.0% rdg + 3V)

**Earth resistance**

Range [ $\Omega$ ]	Resolution [ $\Omega$ ]	Accuracy (*)
0.01 ÷ 9.99	0.01	$\pm(5\% \text{ reading} + 3 \text{ digits})$
10.0 ÷ 99.9	0.1	
100 ÷ 999	1	
1.00k ÷ 49.99k	0.01k	

Test current: <10mA, 77.5Hz; Open-circuit voltage: <20Vrms

(\*) If  $100 \cdot R_{\text{meas}} < (R_s \text{ or } R_h) < 1000 \cdot R_{\text{meas}}$ , add 5% to te accuracy. Accuracy not declared if  $(R_s \text{ or } R_h) > 1000 \cdot R_{\text{mis}}$

**Ground resistivity**

Range [ $\Omega\text{m}$ ]	Resolution [ $\Omega\text{m}$ ]	Accuracy (*)
0.06 ÷ 9.99	0.01	$\pm(5\% \text{ reading} + 3 \text{ digits})$
10.0 ÷ 99.9	0.1	
100 ÷ 999	1	
1.00k ÷ 9.99k	0.01k	
10.0k ÷ 99.9k	0.1k	
100k ÷ 999k	1k	
1.00M ÷ 3.14M	0.01M	

(\*) with distance between the probes  $d=10\text{m}$ ; Distance range:  $1 \div 10\text{m}$

Test current: <10mA, 77.5Hz; Open-circuit voltage: <20Vrms

**Phase rotation with 1 test lead**

Voltage range P-N, P-PE[V]	Frequency range
100 ÷ 265	50Hz/60Hz $\pm 5\%$

Measurement is only carried out by direct contact with metal live parts (not on insulation sheath).

**Voltage drop**

Range [%]	Resolution [%]	Accuracy
0 ÷ 100	0.1	$\pm(10\% \text{ rdg} + 4 \text{ dgt})$

**Leakage current (input In1 – STD clamp)**

Range [mA]	Resolution [mA]	Accuracy
2 ÷ 999	1	$\pm(5.0\% \text{ rdg} + 2 \text{ digits})$

**Environmental parameters**

Measurement	Range	Resolution	Accuracy
$^{\circ}\text{C}$	-20.0 ÷ 60.0 $^{\circ}\text{C}$	0.1 $^{\circ}\text{C}$	$\pm(2\% \text{ rdg} + 2 \text{ digits})$
$^{\circ}\text{F}$	-4.0 ÷ 140.0 $^{\circ}\text{F}$	0.1 $^{\circ}\text{F}$	
RH%	0.0% ÷ 100.0%RH	0.1%RH	
DC voltage	0.1mV ÷ 1.0V	0.1mV	
Lux	0.001 ÷ 20.00lux (*)	0.001 ÷ 0.02Lux	
	0.1 ÷ 2.0klux (*)	0.1 ÷ 2Lux	
	1 ÷ 20.0klux (*)	1 ÷ 20Lux	

(\*) Accuracy of the luxmetric probe according to Class AA



**MEASUREMENT OF NETWORK PARAMETERS AND HARMONICS**
**Voltage**

Range [V]	Resolution [V]	Accuracy
15.0 ÷ 459.9	0.1V	$\pm(1.0\%rdg + 1dgt)$

 Crest factor  $\leq 1,5$  ; Frequency: 42.5 ÷ 69.0 Hz

**Frequency**

Range [Hz]	Resolution [Hz]	Accuracy
42.5 ÷ 69.0	0.01	$\pm(2.0\%rdg + 2dgt)$

Allowed voltage: 15.0 ÷ 459.9V ; Allowed current: 5%FS clamp ÷ FS clamp

**AC Current**

FS clamp	Range [A]	Resolution [A]	Accuracy
$\leq 10A$	5% FS ÷ 9.99	0.01	1Ph: $\pm(1.0\%rdg + 3 dgt)$ 3Ph: $\pm(2.0\%rdg + 5 dgt)$
$10A \leq FS \leq 200$	5% FS ÷ 199.9	0.1	
$200A \leq FS \leq 3000$	5% FS ÷ 2999	1	

Range: 5 ÷ 999.9 mV, values under 5mV are zeroed

 Crest factor  $\leq 3$ ; Frequency: 42.5 ÷ 69.0 Hz

**Active power (@ 230V in 1Ph systems, 400V in 3Ph systems,  $\cos\phi=1$ , f=50.0Hz)**

FS clamp	Range [kW]	Resolution [kW]	Accuracy
$\leq 10A$	0.000 ÷ 9.999	0.001	1Ph: $\pm(2.0\%rdg + 5 rdg)$ 3Ph: $\pm(2.5\%rdg + 8 rdg)$
$10A \leq FS \leq 200$	0.00 ÷ 999.99	0.01	
$200A \leq FS \leq 1000$	0.0 ÷ 999.9	0.1	
$1000A \leq FS \leq 3000$	0 ÷ 9999	1	

**Reactive power (@ 230V in 1Ph systems, 400V in 3Ph systems,  $\cos\phi=0$ , f=50.0Hz)**

FS clamp	Range [kVAr]	Resolution [kVAr]	Accuracy
$\leq 10A$	0.000 ÷ 9.999	0.001	1Ph: $\pm(2.0\%rdg + 7 rdg)$ 3Ph: $\pm(3.0\%rdg + 8 rdg)$
$10A \leq FS \leq 200$	0.00 ÷ 999.99	0.01	
$200A \leq FS \leq 1000$	0.0 ÷ 999.9	0.1	
$1000A \leq FS \leq 3000$	0 ÷ 9999	1	

**Power factor (@ 230V in 1Ph systems, 400V in 3Ph systems, f=50.0Hz)**

Range	Resolution	Accuracy
0.70c ÷ 1.00 ÷ 0.70i	0.01	$\pm(4.0\%rdg + 10rdg)$ if $I \leq 10\%FS$ $\pm(2.0\%rdg + 3rdg)$ if $I > 10\%FS$

 **$\cos\phi$  (@ 230V in 1Ph systems, 400V in 3Ph systems, f=50.0Hz)**

Range	Resolution	Accuracy
0.70c ÷ 1.00 ÷ 0.70i	0.01	$\pm(4.0\%rdg + 10rdg)$ if $I \leq 10\%FS$ $\pm(1.0\%rdg + 7rdg)$ if $I > 10\%FS$

**Voltage harmonics (@ 230V in 1Ph systems, 400V in 3Ph systems, f=50.0Hz)**

Range [%]	Resolution [%]	Ordine	Accuracy
0.1 ÷ 100.0	0.1	01 ÷ 25	$\pm(5.0\%rdg + 5rdg)$

Fundamental frequency: 42.5 ÷ 69.0 Hz, DC accuracy not declared

**Current harmonics (f=50Hz)**

Range [%]	Resolution [%]	Order	Accuracy
0.1 ÷ 100.0	0.1	01 ÷ 9	$\pm(5.0\%rdg + 5rdg)$
		10 ÷ 17	$\pm(10.0\%rdg + 5rdg)$
		18 ÷ 25	$\pm(15.0\%rdg + 10rdg)$

## 11.2. REFERENCE GUIDELINES

Safety:	IEC/EN61010-1, IEC/EN61557-1, -2, -3, -4, -5, -6, -7, -10
EMC :	IEC/EN61326-1
Technical documentation:	IEC/EN61187
Safety of measuring accessories:	IEC/EN61010-031, IEC/EN61010-2-032
Insulation:	double insulation
Pollution level:	2
Max operating altitude:	2000m (6562ft)
Measurement category:	CAT IV 300V to earth, maximum 415V between inputs
LOW $\Omega$ (200mA):	IEC/EN61557-4, BS7671 17th ed., AS/NZS3000/3017
M $\Omega$ :	IEC/EN61557-2, BS7671 17th ed., AS/NZS3000/3017
RCD:	IEC/EN61557-6 (only on Phase-Neutral-Earth systems)
LOOP P-P, P-N, P-PE:	IEC/EN61557-3, BS7671 17th ed., AS/NZS3000/3017
EARTH:	IEC/EN61557-5, BS7671 17th ed., AS/NZS3000/3017
123:	IEC/EN61557-7, BS7671 17th ed., AS/NZS3000/3017
Multifunction:	IEC/EN61557-10, BS7671 17th ed., AS/NZS3000/3017
Short circuit current :	EN60909-0
Earth resistance TN system:	EN61936-1 + EN50522 (not for USA, Germany, Extra Europe countries)

## 11.3. GENERAL CHARACTERISTICS

### Mechanical characteristics

Size (L x W x H):	225 x 165 x 75mm ; (9 x 6 x 3in)
Weight (batteries included):	1.2kg ; (42 ounces)
Mechanical protection :	IP40

### Power supply

Battery type:	6x1.5V alkaline batteries type AA IEC LR06 MN1500 6 x1.2V rechargeable batteries NiMH type AA
Low battery indication:	low battery symbol  on the display
Battery life:	> 500 tests for each function
Auto Power OFF:	after 5 minutes idling (if activated)

### Miscellaneous

Display:	TFT, color, capacitive touch-screen, 320x240pxl
Memory:	999 memory locations, 3 levels of markers
Connection to PC:	optical/USB port
Remote connection:	WiFi connection

## 11.4. ENVIRONMENT

### 11.4.1. Environmental conditions for use

Reference temperature:	23°C $\pm$ 5°C ; (73°F $\pm$ 41°F)
Operating temperature:	0°C $\div$ 40°C ; (32°F $\div$ 104°F)
Allowable relative humidity:	<80%RH
Storage temperature:	-10°C $\div$ 60°C ; (14°F $\div$ 140°F)
Storage humidity:	<80%RH

**This instrument satisfies the requirements of Low Voltage Directive 2014/35/EU (LVD) and of EMC Directive 2014/35/EU**  
**This instrument satisfies the requirements of European Directive 2011/65/EU (RoHS) and 2012/19/EU (WEEE)**

## 11.5. ACCESSORIES

See the attached packing list.

## 12. SERVICE

### 12.1. WARRANTY CONDITIONS

This instrument is warranted against any material or manufacturing defect, in compliance with the general sales conditions. During the warranty period, defective parts may be replaced. However, the manufacturer reserves the right to repair or replace the product. Should the instrument be returned to the After-sales Service or to a Dealer, transport will be at the Customer's charge. However, shipment will be agreed in advance. A report will always be enclosed to a shipment, stating the reasons for the product's return. Only use original packaging for shipment. Any damage due to the use of non-original packaging material will be charged to the Customer. The manufacturer declines any responsibility for injury to people or damage to property.

The warranty shall not apply in the following cases:

- Repair and/or replacement of accessories and battery (not covered by warranty).
- Repairs that may become necessary as a consequence of an incorrect use of the instrument or due to its use together with non-compatible appliances.
- Repairs that may become necessary as a consequence of improper packaging.
- Repairs which may become necessary as a consequence of interventions performed by unauthorized personnel.
- Modifications to the instrument performed without the manufacturer's explicit authorization.
- Use not provided for in the instrument's specifications or in the instruction manual.

The content of this manual cannot be reproduced in any form without the manufacturer's authorization.

**Our products are patented and our trademarks are registered. The manufacturer reserves the right to make changes in the specifications and prices if this is due to improvements in technology.**

### 12.2. SERVICE

If the instrument does not operate properly, before contacting the After-sales Service, please check the conditions of batteries and cables and replace them, if necessary. Should the instrument still operate improperly, check that the product is operated according to the instructions given in this manual. Should the instrument be returned to the After-sales Service or to a Dealer, transport will be at the Customer's charge. However, shipment will be agreed in advance. A report will always be enclosed to a shipment, stating the reasons for the product's return. Only use original packaging for shipment; any damage due to the use of non-original packaging material will be charged to the Customer.

## 13. THEORETICAL APPENDIXES

### 13.1. CONTINUITY OF PROTECTIVE CONDUCTORS

#### Purpose of the test

Check the continuity of:

- Protective conductors (PE), main equalizing potential conductors (EQP), secondary equalizing potential conductors (EQS) in TT and TN-S systems
- Neutral conductors having functions of protective conductors (PEN) in TN-C system.

This test is to be preceded by a visual check verifying the existence of yellow-green protective and equalizing potential conductors as well as compliance of the sections used with the standards requirements.

#### Parts of the system to be checked

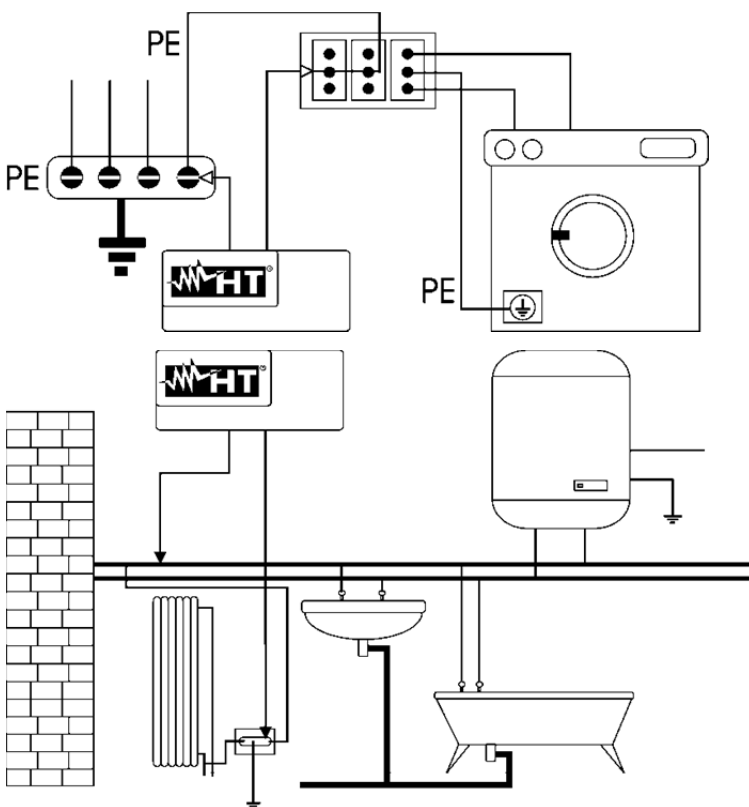

Connect one of the test leads to the protective conductor of the socket and the other to the equalizing potential node of the earth installation.

Connect one of the test leads to the external mass (in this case the water pipe) and the other to the earth installation using for example the protective conductor of the closest socket.

Fig. 44: Examples for continuity measurements on conductors

Check the continuity among:

- Earth poles of all the plug sockets and earth collector or node
- Earth terminals of class I appliances (boilers, etc.) and earth collector or node
- Main external masses (water tubes, gas pipes, etc.) and earth collector or node
- Additional external masses between each other and to earth terminal.

#### Allowable values

The standards do not require the measurement of continuity resistance and the comparison of the results with limit values. The standards simply require that the instrument in use warns the operator if the test was not carried out with a current of at least 200mA and an open circuit voltage ranging from 4 to 24V. The resistance values may be calculated according to the sections and lengths of the conductors under test. In general, if the instrument detects values of some ohms, the test may be considered as successful.

## 13.2. INSULATION RESISTANCE

### Purpose of the test

Check that the insulation resistance of the installation complies with the requirements of the applicable guidelines. This test has to be performed with the circuit being tested not powered and with the possible loads it supplies disconnected.

### Parts of the system to be checked

Check that the insulation resistance between:

- Each active conductor and the earth (the neutral conductor is considered as an active conductor except in TN-C power supply systems, where it is considered as part of the earthing (PEN)). During this measurement, all active conductors may be connected to each other. Should the measurement result not to be within the limits prescribed by the standards, the test must be repeated separately for each single conductor.
- The active conductors. The guidelines recommends also checking the insulation between active conductors when this is possible.

### Allowable values

The values of the measured voltage and of the minimum insulation resistance can be taken from the following table

Circuit nominal voltage [V]	Test voltage [V]	Insulation resistance [MΩ]
SELV and PELV *	250	≥ 0,250
Up to/equal to 500 V, except for the above-mentioned circuits	500	≥ 1,000
Over 500 V	1000	≥ 1,000

\* The terms SELV and PELV replace, in the standards new wording, the old definitions of "Very low safety voltage" or "Very low functional voltage"

Table 5: Most common test types, insulation resistance measurement

If the system includes electronic devices, it is necessary to disconnect them from the system to prevent any damage. Should this not be possible, only perform the test between active conductors (which, in this case, must be connected to each other) and the earth connection.

In the presence of a very extended circuit, wires running side by side constitute a capacity that the instrument must load in order to obtain a correct measurement; in this case it is advisable to hold the start button of the measurement (in case you run the test in manual mode) until the result is stable.

The "> full scale" message indicates that the insulation resistance measured by the instrument is higher than the maximum measurable resistance, this result is obviously much higher than the minimum limits in the standard table above, so the insulation at that point is to be considered compliant.

### 13.3. CHECKING CIRCUIT SEPARATION

#### **Definitions**

A **SELV** system is a zero-category system or safety extra low voltage system characterized by power supply from an independent (e.g. batteries, small generator set) or safety source (e.g. safety transformer), protective separation from other electrical systems (double or reinforced insulation or earthed metal screen) and absence of earthed points (insulated from the earth).

A **PELV** system is a zero-category system or protective extra low voltage system characterized by power supply from an independent (e.g. batteries, small generator set) or safety source (e.g. safety transformer), protective separation from other electrical systems (double or reinforced insulation or earthed metal screen) and, unlike **SELV** systems, presence of earthed points (not insulated from the earth).

A system with **Electrical Separation** is a system characterized by a power supply from an insulation transformer or independent source with equivalent characteristics (e.g. motor generator set), protective separation from other electrical systems (insulation no lower than that of the insulation transformer), protective separation to earth (insulation no lower than that of the insulation transformer).

#### **Purpose of the test**

The test, to be performed if protection is obtained through separation must check that the insulation resistance measured as described below (according to the type of separation) complies with the limits reported in the table relating to insulation measurements.

#### **Parts of the system to be checked**

- **SELV System (Safety Extra Low Voltage):**
  - ✓ Measure the resistance between the active parts of the circuit being tested (separated) and the active parts of the other circuits.
  - ✓ Measure the resistance between the active parts of the circuit to be tested (separated) and the earth.
  
- **PELV System (Protective Extra Low Voltage):**
  - ✓ Measure the resistance between the active parts of the circuit being tested (separated) and the active parts of the other circuits.

#### **Electrical separation:**

- ✓ Measure the resistance between the active parts of the circuit being tested (separated) and the active parts of the other circuits.
- ✓ Measure the resistance between the active parts of the circuit to be tested (separated) and the earth.

#### **Allowable values**

The test has a positive result when the insulation resistance shows values higher or equal to those indicated in Table 5.



**EXAMPLE OF SEPARATION TEST BETWEEN ELECTRICAL CIRCUITS**

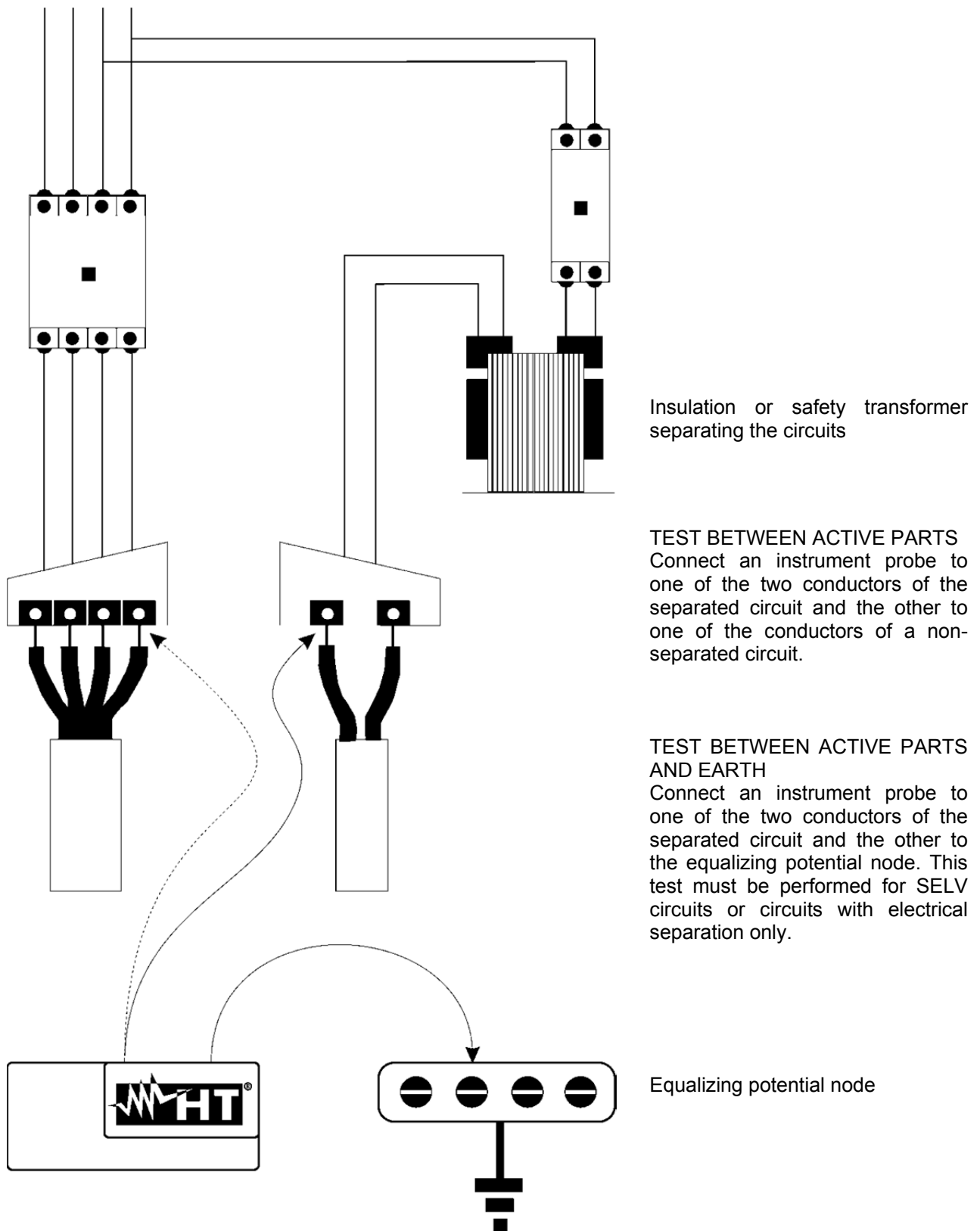

Fig. 45: Separation measurements between the circuits of a system

### 13.4. TEST ON DIFFERENTIAL SWITCHES (RCD)

#### Purpose of the test

Checking that the General (G) and Selective (S) and Delayed (Ⓢ) differential protection devices have been correctly installed and adjusted and that they maintain their characteristics over time. The check must make sure that the differential switch trips at a current not higher than its nominal operating current  $I_{dN}$  and that the tripping time meets the following conditions, according to the case:

- The tripping time does not exceed the maximum time as prescribed by the standard for differential switches of a General type (according to what described in Table 6).
- The tripping time is between the minimum and the maximum tripping time for differential switches of a Selective type (according to what described in Table 6).
- It does not exceed the maximum delay time (normally set by the user) in case of Delayed differential switches.

The differential switch test performed with the test key helps so that no “gluing effect” jeopardizes the operation of the device if it has remained unused for a long time. This test is only performed to ascertain the mechanical functionality of the device and it is not sufficient to declare the devices conformity to the standard regarding differential current devices. According to statistics, switch verification through test key, if performed once a month, reduces to a half the devices malfunction rate. However, this test only detects 24% of the defective differential switches.

#### Parts of the system to be checked

All differential switches must be tested upon installation. In low-voltage systems, it is advisable to perform this test, fundamental in order to guarantee a correct safety level. In medical rooms, this test must be performed periodically on all differential switches as prescribed by the guidelines.

#### Allowable values

On each molded type RCD two tests must be performed on each differential switch: a test with a leakage current beginning in phase with the positive half-wave of voltage ( $0^\circ$ ) and a test with a leakage current beginning in phase with the negative half-wave of voltage ( $180^\circ$ ). The result to be considered is the higher one. The test with  $\frac{1}{2}I_n$  must not cause the differential switch tripping.

RCD type	$I_{dN} \times 1$	$I_{dN} \times 2$	$I_{dN} \times 5^*$	Description
General	0.3s	0.15s	0.04s	Maximum tripping time in seconds
Selective S	0.13s	0.05s	0.05s	Minimum tripping time in seconds
	0.5s	0.20s	0.15s	Maximum tripping time in seconds

Table 6: Tripping times for general and selective differential switches

#### **Trip-out times compliance with AS/NZS 3017 guideline (\*\*)**

RCD type	$I_{dN}$ [mA]	$\frac{1}{2} I_{dN}^*$	$I_{dN}$	$5 \times I_{dN}$	Note
		$t_{\Delta}$ [ms]			
I	$\leq 10$	>999ms	40		Maximum tripping time
II	$>10 \leq 30$		300	40	
III	$> 30$		500	150	
IV [S]	$> 30$		130	50	Minimum non-actuating time

Table 7: Tripping times for general and selective differential switches in AUS/NZ country

(\*) Minimum test period for current of  $\frac{1}{2} I_{dN}$ , RCD shall no trip-out

(\*\*) Test current and measurement accuracy correspond to AS/NZS 3017 requirements

**Measurement of tripping current for protection differential switches**

- This test aims at checking the real tripping current of general differential switches (**it does not apply to selective differential switches**).
- In the presence of differential switches with selectable tripping current, it is useful to perform this test in order to check the real tripping current of the differential switch. For differential switches with fixed differential current, this test may be performed in order to detect possible leakages of the users connected to the system.
- Should an earth system not be available, perform the test by connecting the instrument to a terminal on a conductor downstream of the differential device and a terminal on the other conductor upstream of the device.
- Tripping current must be between  $\frac{1}{2}I_{dn}$  and  $I_{dn}$

**13.5. VERIFY OF THE BREAKING CAPACITY OF PROTECTION DEVICES**

**Purpose of the test**

Checking that the breaking capacity of the protection device is higher than the maximum fault current possible in the system.

**Parts of the system to be checked**

The test must be performed at the point in which the maximum short-circuit current is possible, normally immediately downstream of the protection device to be checked.

The test must be performed between phase and phase ( $Z_{pp}$ ) in three-phase systems and between phase and neutral ( $Z_{pn}$ ) in single-phase systems.

**Allowable values**

The instrument performs the comparison between the measured value and the value calculated according to the following relationships derived from standard EN60909-0:

$$BC > I_{MAX\ 3\Phi} = C_{MAX} \cdot \frac{\frac{U_{L-L}^{NOM}}{\sqrt{3}}}{\frac{Z_{L-L}}{2}}$$

**Three-phase systems**

$$BC > I_{MAX\ L-N} = C_{MAX} \cdot \frac{U_{L-N}^{NOM}}{Z_{L-N}}$$

**Single-phase systems**

where: BC = breaking capacity of protection device  
 $Z_{LL}$  = Impedance measured between phase and phase  
 $Z_{LN}$  = Impedance measured between phase and neutral

Measured voltage	$U_{NOM}$	$C_{MAX}$
$230V-10\% < V_{measured} < 230V+ 10\%$	230V	1.05
$230V+10\% < V_{measured} < 400V- 10\%$	$V_{measured}$	1.10
$400V-10\% < V_{measured} < 400V+ 10\%$	400V	1.05

### 13.6. VERIFY OF PROTECTION AGAINST INDIRECT CONTACTS IN TN SYSTEMS

#### Purpose of the test

The protection against indirect contacts in the TN systems must be guaranteed by means of a protection device against the overcurrents (typically MCB or fuse) which switches off the power supply of the circuit or the electrical equipment in case of a fault between an active part and a ground mass or a protection conductor within an interval not exceeding 5s, sufficient for the equipments, or in compliance with the times declared in the following table. For other countries refer to the respective guidelines.

U <sub>0</sub> [V]	Trip out time of protection [s]
50 ÷ 120	0.8
120 ÷ 230	0.4
230 ÷ 400	0.2
>400	0.1

Table 8: Tripping times for protection devices

U<sub>0</sub> = nominal AC voltage refer to ground of the system

The above conditions are satisfied by the following relationship:

$$Z_s \cdot I_a \leq U_0$$

where:

- Z<sub>s</sub> = Fault Loop P-PE impedance which includes the phase winding of the transformer, the line conductor up to the fault point and the protective conductor from the fault point to the star center of the transformer
- I<sub>a</sub> = Tripping current of the protection device within the specified time in Table 8
- U<sub>0</sub> = nominal AC voltage refer to ground

#### CAUTION



The instrument must be used to measure fault loop impedance values at least 10 times higher than the resolution value of the instrument in order to minimize errors.

#### Parts of the system to be checked

The test must necessarily be performed on TN and IT systems not protected by differential devices.

#### Allowable values

The measurement is aimed at ensuring that in every point of the system the relationships derived from standard EN60909-0 are satisfied:

$$I_a \leq I_{MIN\ P-PE} = C_{MIN} \cdot \frac{U_{P-PE}^{NOM}}{Z_{P-PE}}$$

Measured voltage	U <sub>NOM</sub>	C <sub>MIN</sub>
230V-10% < V <sub>measured</sub> < 230V+ 10%	230V	0.95
230V+10% < V <sub>measured</sub> < 400V- 10%	V <sub>measured</sub>	1.00
400V-10% < V <sub>measured</sub> < 400V+ 10%	400V	0.95

Depending on the set values of phase-phase, phase-neutral or phase-PE voltage (see § 5.1.4) and the measured value of fault loop impedance, the instrument calculates the **minimum value** of the assumed short-circuit current to be interrupted by the protection device. For proper coordination, this value **MUST** always be greater than or equal to the **I<sub>a</sub>** value of the tripping current of the type of protection considered.

The **I<sub>a</sub>** reference value (see Fig. 46) depends on:

- Protection type (curve)
- Rated current of the protection device
- Time of fault extinction by the protection

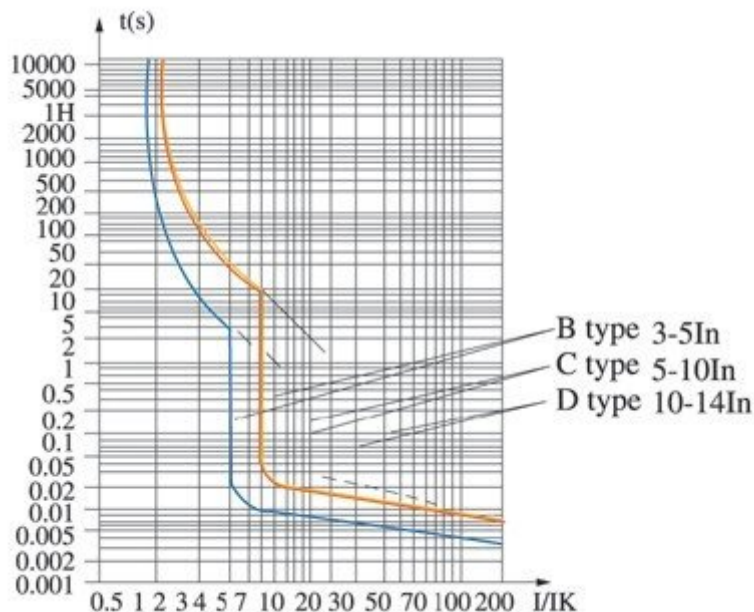

Fig. 46: Example of curves relative to magnetothermal (MCB) protection

The instrument allows the selection (\*) of the following parameters:

- MCB current (B curve) selectable among values: **3,6,10,13,15,16,20,25,32,40,45,50,63,80,100,125,160,200A**
- MCB current (C, K, D curves) selectable among values: **0.5,1,1.6,2,3,4,6,10,13,15,16,20,25,32,40,50,63, 80,100,125,160,200A**
- Nominal current Fuse BS88-2 selectable among values: **2, 4, 6, 10, 16, 20, 25, 32, 40, 50, 63, 80, 100, 125, 160, 200A**
- Nominal current Fuse BS88-3 selectable among values: **5,16,20,32,45,63,80,100A**
- Nominal current Fuse BS3036 selectable among values: **5,15,20,30,45,60,100A**
- Nominal current Fuse BS1362 selectable among values: **3,15A**
- Time of fault extinction by the protection selectable among: **0.1s, 0.2s, 0.4s, 1s, 5s**

(\*) The values could be subject to variations

### 13.7. NO TRIP TEST IN TN SYSTEMS

The protection against indirect contacts in the TN systems must be guaranteed by means of a protection device against the overcurrents (typically MCB or fuse) which switches off the power supply of the circuit or the electrical equipment in case of a fault between an active part and a ground mass or a protection conductor within an interval not exceeding 5s, sufficient for the equipments.

#### Parts of the system to be checked

The test must be performed at the point in which the minimum short-circuit current is possible, normally immediately downstream of the protection device to be checked.

The test must be performed between phase and PE ( $Z_{L-PE}$ ) and between phase and neutral ( $Z_{L-N}$ ) in three-phase systems or single-phase systems.

#### Allowable values

The measurement is aimed at ensuring that in every point of the system the following relationships are satisfied:

$$Z_{L-PE} \leq Z_{LIM} \quad (1)$$

$$Z_{L-N} \leq Z_{LIM} \quad (2)$$

where:

- $Z_{L-PE}$  = Impedance measured between phase and PE
- $Z_{L-N}$  = Impedance measured between phase and neutral
- $Z_{LIM}$  = Maximum limit impedance depending on type (MCB or Fuse) and tripping time of the selected protection (values depending on countries)

The following selections (\*) are available on the instrument:

- MCB current (B curve) selectable among values: **3,6,10,16,20,25,32,40,50,63,80,100,125,160,200A**
- MCB current (C, K, D curves) selectable among values: **0.5,1,1.6,2,3,4,6,10,13,15,16,20,25,32,40,50,63, 80,100,125,160,200A**
- Nominal current Fuse BS88-2 selectable among values: **2, 4, 6, 10, 16, 20, 25, 32, 40, 50, 63, 80, 100, 125, 160, 200A**
- Nominal current Fuse BS88-3 selectable among values: **5,16,20,32,45,63,80,100A**
- Nominal current Fuse BS3036 selectable among values: **5,15,20,30,45,60,100A**
- Nominal current Fuse BS1362 selectable among values: **3,15A**
- Time of fault extinction by the protection selectable among: **0.1s, 0.2s, 0.4s, 1s, 5s**

(\*) The values could be subject to variations



### 13.8. VERIFY OF PROTECTION AGAINST INDIRECT CONTACTS IN TT SYSTEMS

#### Purpose of the test

Checking that the protection device is coordinated with the value of earth resistance. We cannot assume a priori a reference limit value for earth resistance as a reference when checking the measurements result. It is necessary to check each time that the coordination prescribed by the standard is met.

#### Parts of the system to be checked

Earth installation in operating conditions. The test must be performed without disconnecting the earth rods.

#### Allowable values

The value of earth resistance, however measured, must satisfy the following relation:

$$R_A < 50 / I_a$$

where:  $R_A$  = resistance measured of earth installation whose value can be determined with the following measurements:

- Three-wire earth resistance with voltammetric method
- Impedance of the fault ring (\*)
- Earth resistance with two wires (\*\*)
- Earth resistance with two wires in socket (\*\*)
- Earth resistance obtained by the measurement of contact voltage  $U_t$  (\*\*)
- Earth resistance obtained by the tripping time test of the RCDs (A, AC, B), RCD S (A, AC) (\*\*)

$I_a$  = tripping current of the automatic RCD or rated tripping current of the RCD (in case of RCD S 2  $I_{dN}$ ) in ampere

50 = safety limit voltage (reduced down to 25V in special environments)

(\*) If the system protection is obtained through a differential switch, the measurement must be performed upstream of this switch or downstream of it by short-circuiting the switch in order to prevent it from tripping.

(\*\*) These methods, although not currently foreseen by guidelines provide values that have been proven indicative of the earth resistance by numerous comparisons with the three-wire method.

#### EXAMPLE OF EARTH RESISTANCE CHECK

System protected by a 30mA differential switch.

- Let us measure the earth resistance by using one of the above-mentioned methods.
- In order to understand if the system resistance is to be considered as compliant with the standards, we need to multiply the value found by 0.03A (30mA).
- If the result is lower than 50V (or 25V for special environments), the system can be considered as coordinated, as it satisfies the relationship indicated above.
- When dealing with 30mA differential switches (as in almost all civil systems), the maximum allowable earth resistance is  $50/0.03=1666\Omega$ . This enables using also the indicated simplified methods which, although they do not provide an extremely precise value, provide a sufficiently approximated value for coordination calculation.

### 13.9. VERIFY OF PROTECTION AGAINST INDIRECT CONTACTS IN IT SYSTEMS

In IT systems the active parts must be isolated from the ground or be connected to earth through an impedance of sufficiently high value. In the case of a single earth fault current of the first fault is weak and therefore it is not necessary to interrupt the circuit. This connection can be made to the neutral point of the system or to an artificial neutral point. If there is no neutral point, can be connected to earth through an impedance of a line conductor. It must, however, take precautions to avoid the risk of harmful physiological effects on people in contact with conductive parts simultaneously accessible in the case of a double earth fault.

#### **Purpose of the test**

Verify that the impedance of the ground probe in which the mass are connected satisfyteh following relationship:

$$Z_E * I_d \leq U_L$$

where:

- $Z_E$  = L-PE impedance of the ground probe in which the mass are connected
- $I_d$  = L-PE current of first fault (typically expressed in mA)
- $U_L$  = Limit contact voltage 25V or 50V

#### **Parts of the system to be checked**

The earth system under operating conditions. The verification should be performed without disconnecting the ground probes.

### 13.10. VERIFY OF PROTECTION COORDINATION L-L, L-N AND L-PE

#### Purpose of the test

Test the coordination of protective devices (typically MCB or fuse) present in a Single-phase or Three-phase installation as a function of the limit time of fault extinction by the protection set by the user and the calculated value of the short-circuit current.

#### Parts of the system to be checked

The test must be performed at the point in which the minimum short-circuit current is possible, normally at the end of the line controlled by the protection device in the normal condition of the line. The test must be performed between Phase-Phase in the Three-phase installations and between Phase-PE or Phase-PE in the Single-phase installation

#### Allowable values

The instrument performs the comparison between the calculated value of short-circuit current and the  $I_a$  = tripping current of the protection device within the specified time, according to the following expressions:

$$I_{SC\ L-L\_Min2\Phi} > I_a \quad \text{Three-phase system} \rightarrow \text{Loop L-L impedance}$$

$$I_{SC\ L-N\_Min} > I_a \quad \text{Single-phase system} \rightarrow \text{Loop L-N impedance}$$

$$I_{SC\ L-PE\_Min} > I_a \quad \text{Single-phase system} \rightarrow \text{Loop L-PE impedance}$$

where:

- Isc L-L\_Min2F = Prospective short-circuit current minimum double phase L-L
- Isc L-N\_Min = Prospective short-circuit current minimum L-N
- Isc L-PE\_Min = Prospective short-circuit current minimum L-PE

The calculation of prospective short-circuit current is performed by the instrument based on the fault loop impedance measurement in compliance with the following relationships derived from standard EN60909-0:

$$I_{SC\ L-L\_Min2\Phi} = C_{MIN} \cdot \frac{U_{L-L}^{NOM}}{Z_{L-L}} \quad I_{SC\ L-N\_Min} = C_{MIN} \cdot \frac{U_{L-N}^{NOM}}{Z_{L-N}} \quad I_{SC\ L-PE\_Min} = C_{MIN} \cdot \frac{U_{L-PE}^{NOM}}{Z_{L-PE}}$$

**Phase – Phase**

**Phase – Neutral**

**Phase – PE**

Measured voltage	$U_{NOM}$	$C_{MIN}$
230V-10% < Vmeasured < 230V+ 10%	230V	0,95
230V+10% < Vmeasured < 400V- 10%	Vmeasured	1,00
400V-10% < Vmeasured < 400V+ 10%	400V	0,95

where:

- U L-L = Nominal Phase-Phase voltage
- U L-N = Nominal Phase-Neutral voltage
- U L-PE = Nominal Phase-PE voltage
- Z L-L = Impedance Phase-Phase measured
- Z L-N = Impedance Phase-Neutral measured
- Z L-PE = Impedance Phase-PE measured

## CAUTION



The instrument must be used to measure fault loop impedance values at least 10 times higher than the resolution value of the instrument in order to minimize errors.

Depending on the set values of nominal voltage (see § 5.1.4) and the measured value of fault loop impedance, the instrument calculates the **minimum value** of the assumed short-circuit current to be interrupted by the protection device. For proper coordination, this value **MUST** always be greater than or equal to the **I<sub>a</sub>** value of the tripping current of the type of protection considered.

The **I<sub>a</sub>** reference value depends on:

- Protection type (curve)
- Rated current of the protection device
- Time of fault extinction by the protection

The instrument allows the selection (\*) of the following parameters:

- MCB current (B curve) selectable among values: **3,6,10,13,15,16,20,25,32,40,45,50,63,80,100,125,160,200A**
- MCB current (C, K, D curves) selectable among values: **0.5,1,1.6,2,3,4,6,10,13,15,16,20,25,32,40,50,63, 80,100,125,160,200A**
- Nominal current Fuse BS88-2 selectable among values: **6, 10, 16, 20, 25, 32, 40, 50, 63, 80, 100, 125, 160, 200A**
- Nominal current Fuse BS88-3 selectable among values: **5,16,20,32,45,63,80,100A**
- Nominal current Fuse BS3036 selectable among values: **5,15,20,30,45,60,100A**
- Nominal current Fuse BS1362 selectable among values: **3,15A**
- Time of fault extinction by the protection selectable among: **0.1s, 0.2s, 0.4s, 1s, 5s**

(\*) The values could be subject to variations

### 13.11. VERIFY OF THE PROTECTION AGAINST SHORT CIRCUITS – TEST I<sup>2</sup>T

The  $I^2t$  parameter represents the specific energy (expressed in A<sup>2</sup>s) let through by the protective device in short-circuit condition.

The  $I^2t$  energy must be able to be supported both by the cables and by the distribution bars. For cables, the following relation applies:

$$(K * S)^2 \geq I^2t \quad (1)$$

where:

- S = section of the protective conductor in mm<sup>2</sup>  
 K = constant dependent on the material of the protective conductor, on the type of insulation and the temperature that can be obtained from the tables present in the standards (the instrument refers to a fixed environment temperature of 25°C, single cable not buried, no harmonics).

Starting from the evaluation of the three-phase or single-phase **I<sub>sc</sub> short-circuit current**, the instrument calculates the maximum value of  $I^2t$  parameter on the basis of the characteristic curves of the selected protection (MCB or fuse), and runs the comparison with the previous relation (1).

If the test gives a positive result, the **selected section** of the protective conductor is adequate for the management of the protective device chosen. In case of negative result, it is not necessary to select a higher value than the section or change the protection.

The following selections (\*) are available on the instrument:

- MCB current (B curve) selectable among values: **3,6,10,13,15,16,20,25,32,40,45,50,63,80,100,125,160,200A**
- MCB current (C, K, D curves) selectable among values: **0.5,1,1.6,2,3,4,6,10,13,15,16,20,25,32,40,50,63, 80,100,125,160,200A**
- Nominal current Fuse BS88-2 selectable among values: **6, 10, 16, 20, 25, 32, 40, 50, 63, 80, 100, 125, 160, 200A**
- Nominal current Fuse BS88-3 selectable among values: **5,16,20,32,45,63,80,100A**
- Nominal current Fuse BS3036 selectable among values: **5,15,20,30,45,60,100A**
- Nominal current Fuse BS1362 selectable among values: **3,15A**
- Conductor material: selectable between **Cu** (Copper) and **Al** (Aluminum)
- Conductor insulation: selectable among **PVC**, **Rub/Butil** (Rubber/Butyl rubber) and **EPR/XLPE** (Ethylene propylene rubber/Cross-linked polyethylene)
- Conductor section free selectable and possible number of parallel cords (max 99)

#### CAUTION



The verifies made by the instrument does not replace in any case the design calculations

(\*) The values could be subject to variations

### 13.12. VERIFICATION OF VOLTAGE DROP ON MAIN LINES

Measurement voltage drop as a result of current flow through a main line or a part of it can be very important if it is necessary:

- Verify the capability of an existing main line to supply a load
- Dimension a new installation
- Search for possible causes of troubles on devices, loads, etc.. connected to a main line

#### **Purpose of the test**

Measure the maximum percentage value of voltage drop between two points of a main line

#### **Parts of the system to be checked**

The test includes two sequential impedance measurements in the initial point of main power line (typically downstream to a protection device) and in the final point of the same line.

#### **Allowable values**

The instruments compares the calculated value of  $\Delta V\%$  maximum voltage drop to the set limit value (according to applicable guidelines) according to the following relationship:

$$\Delta V\%_{MAX} = \frac{(Z_2 - Z_1) * I_{NOM}}{V_{NOM}} * 100$$

where:

- $Z_2$  = End point impedance of the main line being tested
- $Z_1$  = Initial point impedance (Offset) of the main line being tested ( $Z_2 > Z_1$ )
- $I_{NOM}$  = Nominal current of protection device of the main line being tested
- $V_{NOM}$  = Phase-Neutral or Phase-PE nominal voltage of the main line being tested



### 13.13. MEASUREMENT OF EARTH RESISTANCE IN TN SYSTEMS

#### Purpose of the test

Check that the measured value of earth resistance is lower than the maximum limit calculated on the basis of the maximum allowable contact voltage **U<sub>tp</sub>** for the system.

In accordance with the requirements of standard EN50522 (for USA, Germany and Extra Europe countries refer to the respective guidelines) the maximum allowable contact voltage is dependent on the time duration of the fault according to the following Table 9

Fault duration [s]	Allowed contact voltage U <sub>tp</sub> [V]
10	85
5.00	86
2.00	96
1.00	117
0.50	220
0.20	537
0.10	654
0.05	716

Table 9 Maximum allowable values for contact voltage

#### Allowable values

The maximum earth resistance is calculated using the following relation:

$$R_t \leq \frac{U_{tp}}{I_g}$$

where:

- U<sub>tp</sub> = maximum allowable contact voltage in the system on the basis of the value of U<sub>tp</sub> (the values not included in Table 9 are obtained by linear interpolation) according to the duration time of the fault (value provided by the Energy distribution board)
- I<sub>g</sub> = maximum fault current in the system (value provided by the Energy distribution board)

On the instrument, it is possible to select the value of the time duration of the fault in the range between **0.04s** and **10s** and the value of the fault current in the range between **1A** and **9999A**.

## Measurement of earth impedance by voltammetric method

### Creating cables extensions

If the length of the cables supplied with the instrument is not enough, you can create your own extensions to carry out the measurements in the system without influencing the instrument accuracy and, by the nature of the voltammetric method, **without the need to perform any compensation of measuring cable resistance**.

To create extensions, always adopt the following guidelines to ensure the safety of the operator:

- Always use cables characterized by insulation voltage and insulation class appropriate to the rated voltage and measurement category (overvoltage) of the system under consideration.
- For extension terminals, always use connectors having measurement category (overvoltage) and voltage appropriate for the point where you plan to connect the instrument (see § 1.4). The use of the optional accessories **1066-IECN** (black) and **1066-IECR** (red) is recommended.

### Method for small-sized earth networks

Let a current stream between the earth network under test and an auxiliary rod placed at a distance equal to **fivefold the diagonal of the area limiting the earth installation itself** (see Fig. 47). Place the voltage probe at approximately half way between the earth rod and the current probe, finally measure the voltage between them.

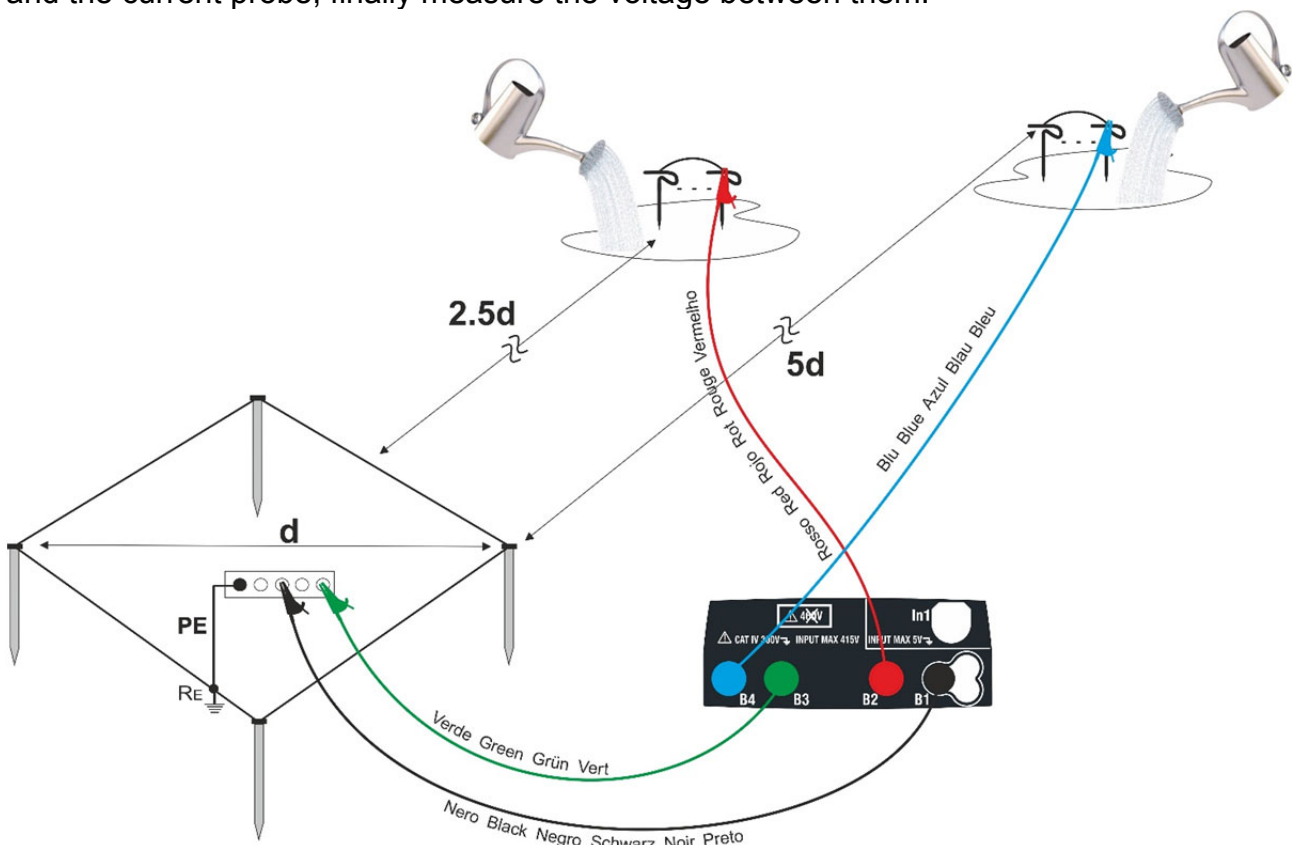

Fig. 47: Ground measurement for small-sized earth networks

If needed, use multiple probes in parallel and wet the surrounding ground (see Fig. 47) if the instrument is not able to supply the current required to perform the test due to a high resistance of the ground.

### **Big-sized earth networks**

This technique is always based on the voltammetric method and is used where it is difficult to position the auxiliary earth current rod at a distance equal to 5 times the diagonal of the area of the ground system **by reducing this distance to once the diagonal of the ground system** (see Fig. 48).

To confirm that the voltage probe is located outside the zone of influence of the system under test and the auxiliary earth rod, it is necessary to perform several measurements by initially placing the voltage probe at the midpoint between the system and the auxiliary current rod, then moving the probe both to the system under consideration and to the auxiliary current rod.

These measurements should provide compatible results, any significant differences between the various measured values indicate that the voltage probe has been stuck within the zone of influence of the system under test or the auxiliary current rod. Such measurements cannot be considered as reliable. It is necessary to further extend the distance between the auxiliary current rod and the rod under test, then repeat the whole procedure as above described.

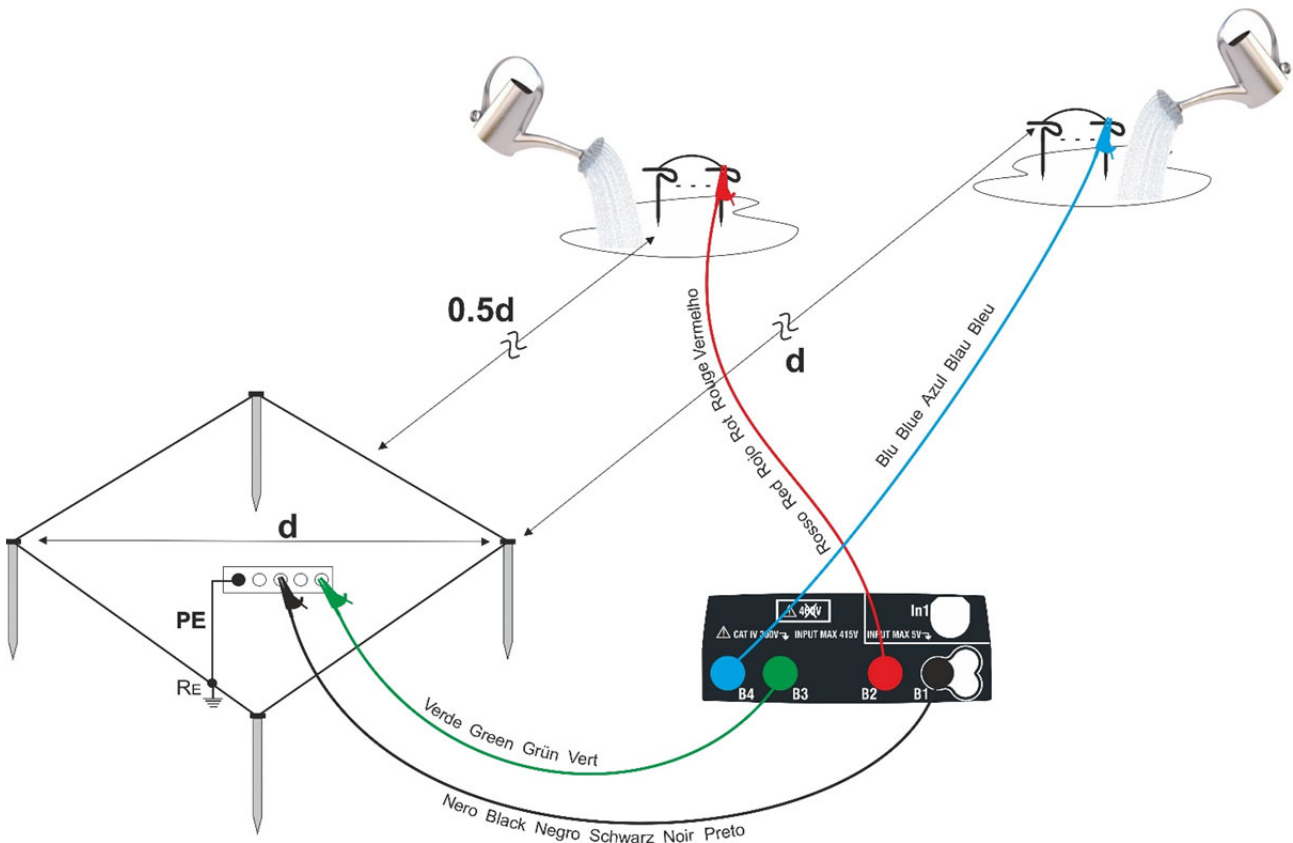

Fig. 48: Ground measurement for big-sized earth networks

Use multiple probes in parallel and wet the surrounding ground (see Fig. 48) if the instrument is not able to supply the current required to perform the test due to a high resistance of the ground.

### Ground resistivity measurement

This test aims at analyzing the resistivity value of the ground in order to define the type of rods to be used when designing the installation. For the measurement of resistivity, there are no correct or incorrect values. The various values obtained using distances between increasing "d" rods should be reported in a graph from which, according to the curve obtained, it is possible to determine the type of rods to use. As the test result can be affected by metal parts buried such as pipes, cables or other rods etc., it is advisable to take a second measurement positioning the rods at an equal distance "d", but rotating their axis by 90° (see Fig. 49).

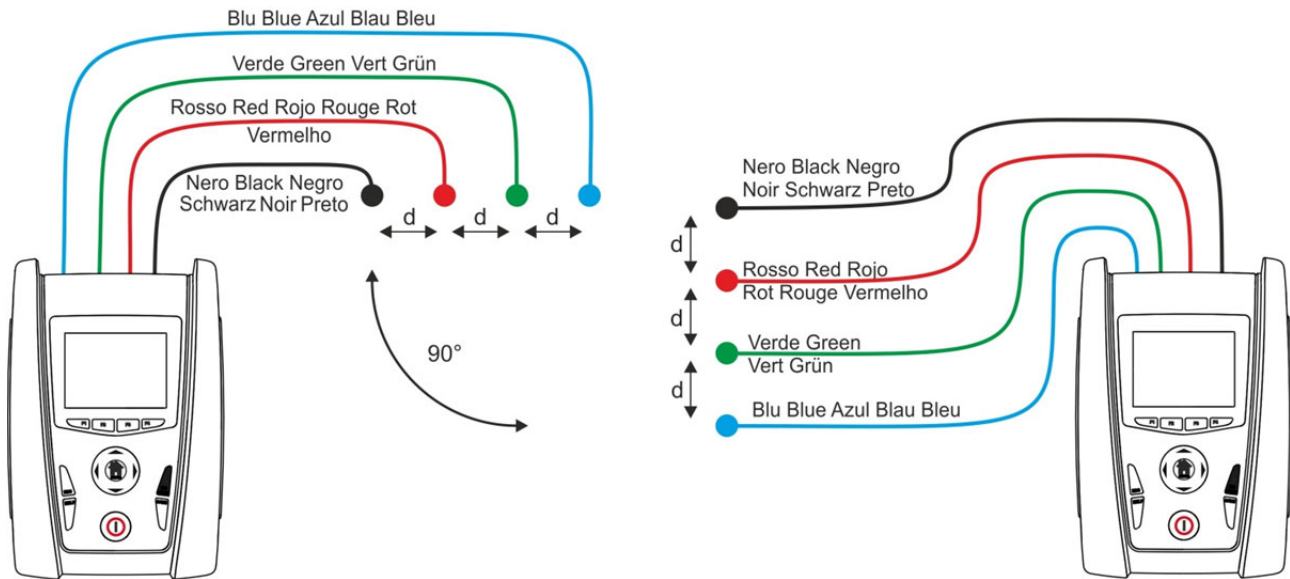
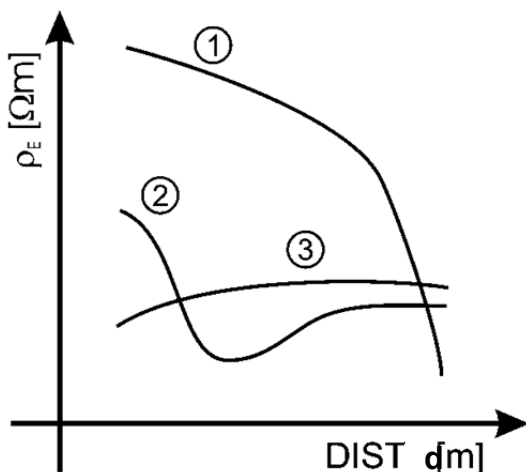

Fig. 49: Ground resistivity measurement

The resistivity value is given by the following relation:  $\rho_E = 2 \pi d R$  where:

- $\rho_E$  = specific ground resistivity
- d = distance between the probes [m]
- R = resistance measured by the instrument [ $\Omega$ ]

The measuring method allows defining the specific resistivity of a ground layer up to the depth corresponding approximately to the distance "d" between the two rods. If you increase the distance "d", you can reach deeper ground layers and check the ground homogeneity. After several measurements you can trace a profile according to which the most suitable rod is chosen.



- Curve 1:** as  $\rho_E$  decreases only in depth, its advisable to use a very deep rod
- Curve 2:**  $\rho_E$  decreases only until the depth **d** it is not useful to increase the depth of the rods beyond a
- Curve 3:** the ground resistivity is quite constant, so increasing depth does not make  $\rho_E$  decrease, therefore a ring rod must be used.

Fig. 50: Ground resistivity measurement

**Approximate evaluation of intentional rods' contribution**

The resistance of an Rd rod can be calculated with the following formulas ( $\rho$  r = average resistivity of the ground).

a) resistance of a vertical rod

$$R_d = \rho / L$$

where L = length of the element touching the ground

b) resistance of a horizontal rod

$$R_d = 2\rho / L$$

where L = length of the element touching the ground

c) resistance of linked elements

The resistance of a complex system made of more elements in parallel is always higher than the resistance, which could result from a simple calculation of single elements in parallel, especially if those elements are close to each other and therefore interactive. For this reason, in case of a linked system the following formula is quicker and more effective than the calculation of the single horizontal and vertical elements:

$$R_d = \rho / 4r$$

where r = radius of the circle which circumscribes the link

### 13.14. VOLTAGE AND CURRENT HARMONICS

Any periodical non-sine wave can be represented as a sum of sinusoidal waves having each a frequency that corresponds to an entire multiple of the fundamental, according to the relation:

$$v(t) = V_0 + \sum_{k=1}^{\infty} V_k \sin(\omega_k t + \varphi_k) \quad (1)$$

where:  $V_0$  = average value of  $v(t)$   
 $V_1$  = amplitude of the fundamental of  $v(t)$   
 $V_k$  = amplitude of the  $k^{\text{th}}$  harmonic of  $v(t)$

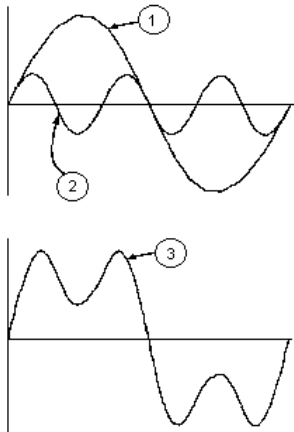

**CAPTION:**

1. Fundamental
2. Third harmonic
3. Distorted waveform

Fig. 51: Effect of the sum of two multiple frequencies

In the mains voltage, the fundamental has a frequency of 50 Hz, the second harmonic has a frequency of 100 Hz, the third harmonic has a frequency of 150 Hz and so on. Harmonic distortion is a constant problem and should not be confused with short events such as sags, surges or fluctuations.

It can be noted that in (1) the index of the sigma is from 1 to the infinite. What happens in reality is that a signal does not have an unlimited number of harmonics: a number always exists after which the harmonics value is negligible. The EN 50160 standard recommends to stop the index in the expression (1) in correspondence of the 40<sup>th</sup> harmonic. A fundamental element to detect the presence of harmonics is THD defined as:

$$THD_v = \frac{\sqrt{\sum_{h=2}^{40} V_h^2}}{V_1}$$

This index takes all the harmonics into account. The higher it is, the more distorted the waveform gets.

#### **Limit values for harmonics**

EN 50160 guideline fixes the limits for the harmonic voltages, which can be introduced into the network by the power supplier. In normal conditions, during whatever period of a week, 95% of the RMS value of each harmonic voltage, mediated on 10 minutes, will have to be inferior than or equal to the values stated in Table 10. The total harmonic distortion (THD) of the supply voltage (including all the harmonics up to 40<sup>th</sup> order) must be inferior than or equal to 8%.



Odd harmonics				Even harmonics	
Not multiple of 3		Multiple of 3		Order h	Relative voltage % Max
Order h	Relative voltage % Max	Order h	Relative voltage % Max		
5	6	3	5	2	2
7	5	9	1,5	4	1
11	3,5	15	0,5	6..24	0,5
13	3	21	0,5		
17	2				
19	1,5				
23	1,5				
25	1,5				

Table 10 Limits for the harmonic voltages the supplier may introduce into the network

These limits, theoretically applicable only for the supplier of electric energy, provide however a series of reference values within which the harmonics introduced into the network by the users must be contained.

#### 13.14.1. Presence of harmonics: causes

- Any apparatus that alters the sine wave or uses only a part of such a wave causes distortions to the sine wave and therefore harmonics. All current signals result in some way virtually distorted. The most common situation is the harmonic distortion caused by non-linear loads such as electric household appliances, personal computers or speed control units for motors. Harmonic distortion causes significant currents at frequencies that are odd multiples of the fundamental frequency. Harmonic currents affect considerably the neutral wire of electric installations.
- In most countries, the mains power is three-phase 50/60Hz with a delta primary and star secondary transformers. The secondary generally provides 230V AC from phase to neutral and 400V AC from phase to phase. Balancing the loads on each phase has always represented an headache for electric systems designers
- Until some ten years ago, in a balanced system, the vectorial sum of the currents in the neutral was zero or quite low (given the difficulty of obtaining a perfect balance). The devices were incandescent lights, small motors and other devices that presented linear loads. The result was an essentially sinusoidal current in each phase and a low current on the neutral at a frequency of 50/60Hz
- “Modern” devices such as TV sets, fluorescent lights, video machines and microwave ovens normally draw current for only a fraction of each cycle thus causing non-linear loads and subsequent non-linear currents. All this generates odd harmonics of the 50/60Hz line frequency. For this reason, the current in the transformers of the distribution boxes contains only a 50Hz (or 60Hz) component but also a 150Hz (or 180Hz) component, a 50Hz (or 300Hz) component and other significant components of harmonic up to 750Hz (or 900Hz) and higher
- The vectorial sum of the currents in a balanced system that feeds non-linear loads may still be quite low. However, the sum does not eliminate all current harmonics. The odd multiples of the third harmonic (called “TRIPLENS”) are added together in the neutral and can cause overheating even with balanced loads.

### 13.14.2. **Presence of harmonics: consequences**

In general, even harmonics, i.e. the 2<sup>nd</sup>, 4<sup>th</sup> etc., do not cause problems. Triple harmonics, odd multiples of three, are added on the neutral (instead of cancelling each other) thus creating a condition of overheating of the wire which is extremely dangerous. Designers should take into consideration the three issues given below when designing a power distribution system that will contain harmonic current:

- The neutral wire must be of sufficient gauge
- The distribution transformer must have an additional cooling system to continue operating at its rated capacity when not suited to the harmonics. This is necessary because the harmonic current in the neutral wire of the secondary circuit circulates in the delta-connected primary circuit. This circulating harmonic current heats up the transformer
- Phase harmonic currents are reflected on the primary circuit and continue back to the power source. This can cause distortion of the voltage wave so that any power factor correction capacitors on the line can be easily overloaded.

The 5<sup>th</sup> and the 11<sup>th</sup> harmonic contrast the current flow through the motors making its operation harder and shortening their average life. In general, the higher the ordinal harmonic number, the smaller its energy is and therefore the impact it will have on the devices (except for transformers).

### 13.15. CALCULATION OF POWERS AND POWER FACTORS

#### Single phase mode

The instrument measures the values of RMS Voltage and RMS Current and calculates the average Power values for each period. The formulas for power calculation are:

$$P = \frac{1}{N} \times \sum_{i=1}^N v_i \times i_i$$

$$S = \sqrt{\frac{1}{N} \times \sum_{i=1}^N v_i^2} \times \sqrt{\frac{1}{N} \times \sum_{i=1}^N i_i^2}$$

$$Q = \sqrt{S^2 - P^2}$$

$$Pf = \frac{P}{S}$$

where:

N = number of samples in the period

#### Three phase balanced mode

The instrument measures the values of RMS Voltage between L1 and L2 phases and RMS Current on L3 phase and calculates the average Power values for each period. The formulas for power calculation are:

$$Q = \sqrt{3} \times \frac{1}{N} \times \sum_{i=1}^N v_i \times i_i$$

$$S = \sqrt{3} \times \sqrt{\frac{1}{N} \times \sum_{i=1}^N v_i^2} \times \sqrt{\frac{1}{N} \times \sum_{i=1}^N i_i^2}$$

$$P = \sqrt{S^2 - Q^2}$$

$$Pf = \frac{P}{S}$$

where:

N = number of samples in the period



**HT INSTRUMENTS SA**

C/ Legalitat, 89  
08024 Barcelona - **ESP**  
Tel.: +34 93 408 17 77, Fax: +34 93 408 36 30  
eMail: info@htinstruments.com  
eMail: info@htinstruments.es  
Web: www.htinstruments.es

**HT INSTRUMENTS USA LLC**

3145 Bordentown Avenue W3  
08859 Parlin - NJ - **USA**  
Tel: +1 719 421 9323  
eMail: sales@ht-instruments.us  
Web: www.ht-instruments.com

**HT ITALIA SRL**

Via della Boaria, 40  
48018 Faenza (RA) - **ITA**  
Tel: +39 0546 621002  
Fax: +39 0546 621144  
eMail: ht@htitalia.it  
Web: www.ht-instruments.com

**HT INSTRUMENTS GMBH**

Am Waldfriedhof 1b  
D-41352 Korschenbroich - **GER**  
Tel: +49 (0) 2161 564 581  
Fax: + 49 (0) 2161 564 583  
eMail: info@ht-instruments.de  
Web: www.ht-instruments.de

**HT INSTRUMENTS BRASIL**

Rua Aguaçu, 171, bl. Ipê, sala 108  
13098321 Campinas SP - **BRA**  
Tel: +55 19 3367.8775  
Fax: +55 19 9979.11325  
eMail: vendas@ht-instruments.com.br  
Web: www.ht-instruments.com.br

**HT ITALIA CHINA OFFICE**

意大利 HT 中国办事处  
Room 3208, 490# Tianhe road, Guangzhou - **CHN**  
地址 : 广州市天河路 490 号壬丰大厦 3208 室  
Tel.: +86 400-882-1983, Fax: +86 (0) 20-38023992  
eMail: zenglx\_73@hotmail.com  
Web: www.guangzhouht.com