

Protecting People, Protecting Productivity



Introducing ATOM, our RFID Safety Interlock



THE QUEEN'S AWARDS
FOR ENTERPRISE:
INTERNATIONAL TRADE
2018



C



US



What is ATOM?

ATOM is a compact and ultra-robust RFID High-Coded Solenoid Interlock that we have added to our ncGard product range.

Suitable for use in applications up to PLe (Cat.4), **ATOM** provides a discreet, easy-to-install solution with monitored inputs and OSSD outputs.

Connection Options:

M12 Quick Disconnects (QD) are supported in single 5 pin, single 8 pin and double 5 pin configurations with the latter for Daisy-Chain applications.

Manual Auxiliary release can be performed with the override driver bit provided (Power to Unlock Only).

Mounting Screws and Cable Requirements:

- **4 x M5 Security-Type Mounting Screws** for securing ATOM Switch and Actuator. (Please refer to ATOM Operating Instructions for specific detailed requirements).
- **4 x M5 Nut / T-Nut / Threaded Hole** for securing ATOM Switch and Actuator.
- **Adhesive Threadlocker** to secure Mounting Screws.
- **Auxiliary Release Driver Bit** (provided) to operate Auxiliary Release Function.
- **Standard M12 Cable(s)** to connect and operate ATOM Switch. (Exact cable depends on connector option).



Dimensional Drawing for ATOM with Actuator Unit

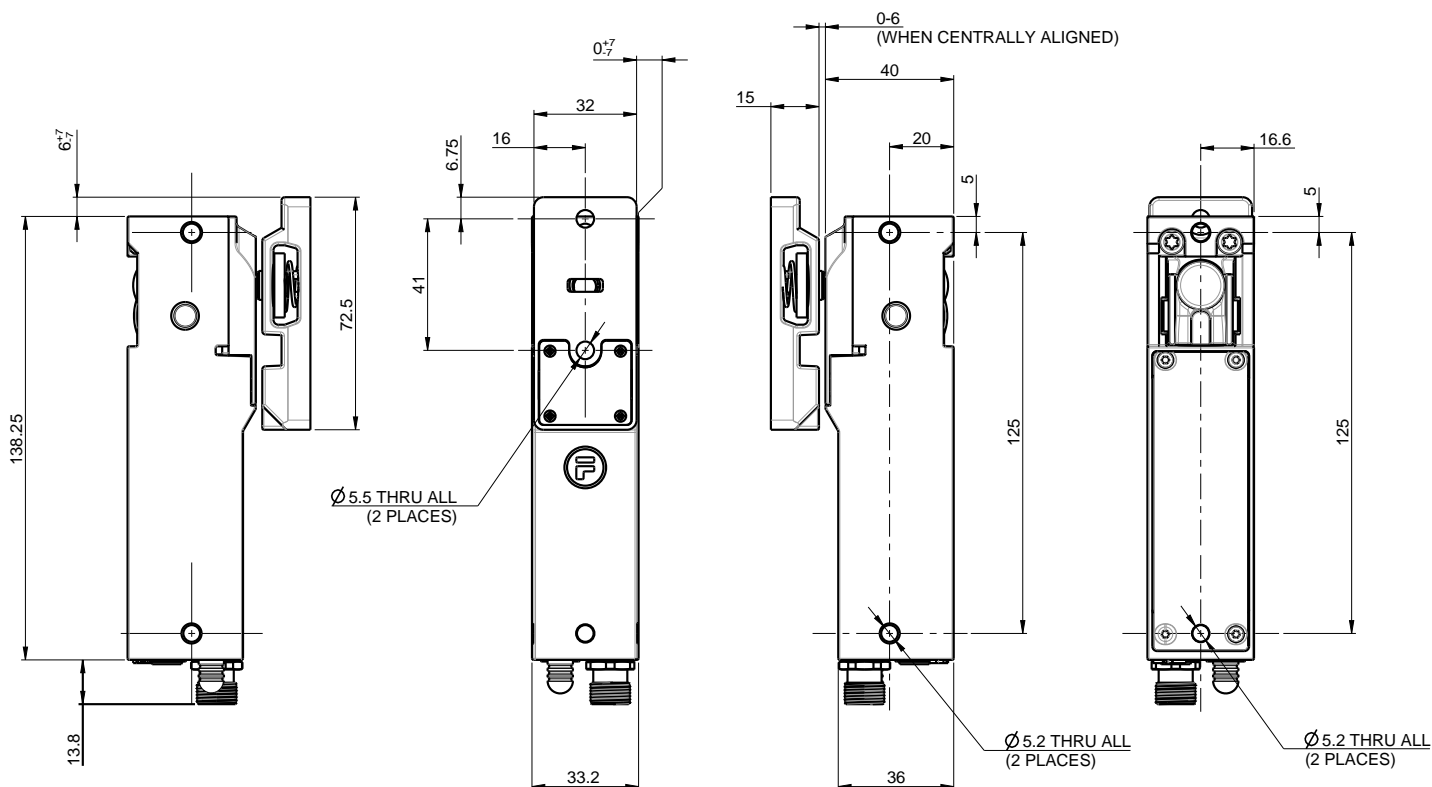

ATOM - High Coded RFID

ATOM has a High-Coded RFID technology that provides millions of different coding combinations and is classed as "high" coding by ISO 14119.

The uniquely coded actuator helps to create a tamper-proof system that prevents unauthorised access.

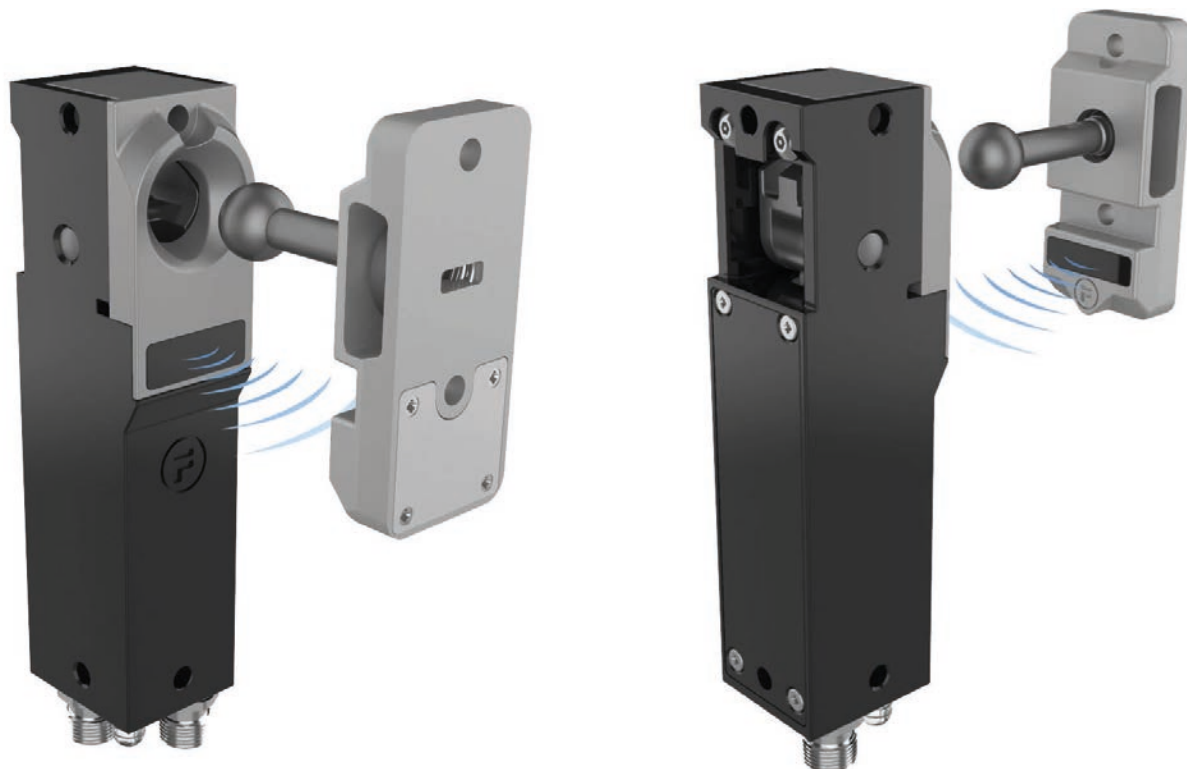

ATOM - OSSD Outputs

ATOM supports OSSD output (**O**utput **S**ignal **S**witching **D**evice) with Daisy-Chain connection that enables ease of wiring installation and prevents fault masking powered from the same supply. Each **ATOM** unit in series draws current and causes a voltage drop on the power line. For a detailed calculation please see the Voltage Drop Tool on the Fortress website.

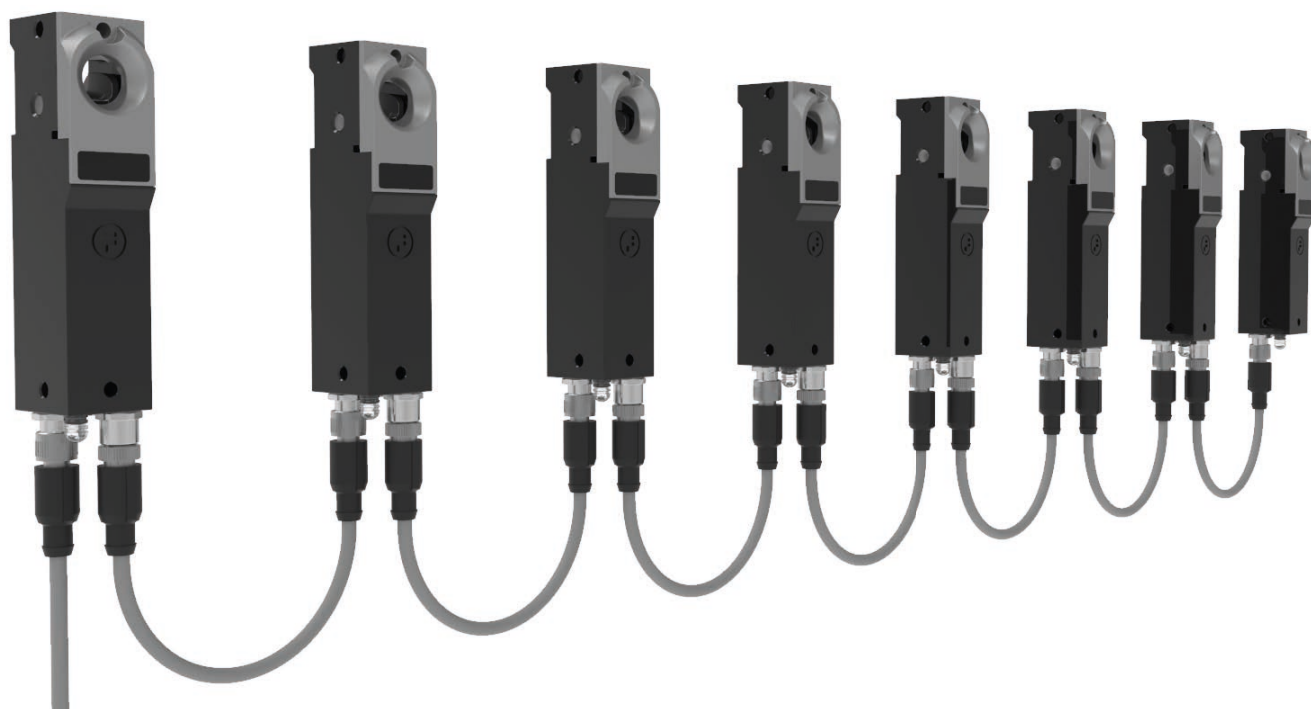

ATOM - High Mechanical Misalignment



The **ATOM** Actuator can pivot and self-centre to operate under a high degree of misalignment.

High maximum retention force of up to 8kN.

Pivoting mechanism is particularly well suited to small radius hinged doors and hatches.



Application Example - ATOM in Action: CNC Machine

If a person requires entry to the machine they must press the 'Request to Stop' button.

The **ATOM** will prevent guard doors from opening whilst the machine is still operating during rundown time.

Once the machine has stopped, the **ATOM's** solenoid is energised which breaks the dual safety circuit to prevent unexpected restart.

Opening the guard door disconnects the RFID connection which prevents inadvertent restart.

High-Coded RFID Technology prevents any attempts to manually defeat the unit.

When intervention is complete, closing the machine door will re-establish the safety circuits and providing the solenoid is de-energised, the **ATOM** unit will then relock and allow for machine restart.



FORTRESS

INTERLOCKS

Protecting People, Protecting Productivity

Introducing ATOM, our NEW RFID Safety Interlock

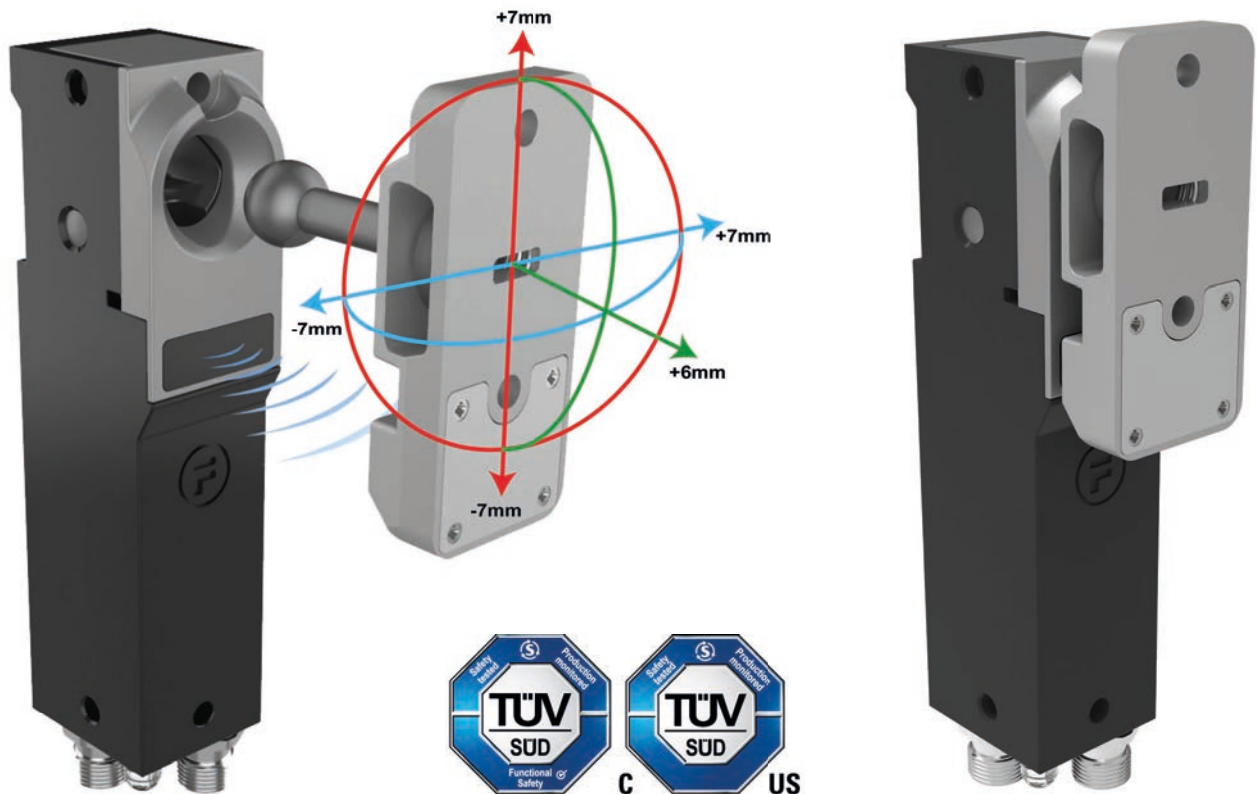

What are the features of ATOM?

Solenoid Controlled Interlock

High-Coded RFID

Robust Actuator design with high locking and retention force (8kN)

Ultra compact mounting footprint, easy to mount with 4 x M5 screws

Safeguarding application up to PLe and SIL3 rating

Provides OSSD outputs with Daisy-Chain connection, connects up to 8 **ATOMs** in series

High Mechanical Misalignment and open head to prevent dust, dirt and corrosion from impacting performance

Sealed to IP65 and IP67





Robust Safety for
Manufacturing Environments

www.fortressinterlocks.com



Protecting People, Protecting Productivity

A **Halma** company



Fortress Interlocks Ltd

 +44 (0)1902 349000
 sales@fortressinterlocks.com



Fortress Interlocks Europe

 +31 (0)10 7536060
 europe@fortressinterlocks.com



Fortress Interlocks USA

 +1 (859) 578 2390
 us@fortressinterlocks.com



Fortress Interlocks Pty Ltd

 +61 (0)3 9771 5350
 australia@fortressinterlocks.com

Fortress Interlocks China

 +86 (021) 6167 9002
 china@fortressinterlocks.com

Fortress Interlocks India

 +91 8657445479
 india@fortressinterlocks.com

Official Distributor