

SDM630 V2 100A SERIES

Three Phase Multifunction Din Rail Energy Meter



DIN RAIL SMART METER FOR SINGLE AND THREE PHASE ELECTRICAL SYSTEMS

User Manual v1.0

1. Introduction

This document provides operating, maintenance and installation instructions. These units measure and display the characteristics of single phase two wires (1p2w), three phase three wires (3p3w) and three phase four wires (3p4w) networks. The measuring parameters include voltage (V), frequency (Hz), current (A), power (kW/kVar/kVAr), import, export and total Energy (kWh/kVarh). The units can also measure Maximum demand current and power, this is measured over preset periods of up to 60 minutes.

These units are max 100A direction operated and do not need to connect with external current transformers (CT). Built-in pulse, RS485 Modbus RTU/Mbus outputs. Configuration is password protected.

1.1 Unit Characteristics

The SDM630 100A V2 series meters have five models: SDM630-Pulse V2, SDM630-Standard V2, SDM630-Modbus V2, SDM630-Mbus V2, SDM630-MT V2.

Model	Measurement	Output	Tariff
SDM630-Pulse V2	kWh/kVarh, kW/kVar, kVA, P, F, PF, dmd, V, A, THD, etc.	pulse	no
SDM630-Standard V2	kWh/kVarh	pulse/Modbus	no
SDM630-Modbus V2	kWh/kVarh, kW/kVar, kVA, P, F, PF, dmd, V, A, THD, etc.	pulse/Modbus	no
SDM630-Mbus V2	kWh/kVarh, kW/kVar, kVA, P, F, PF, dmd, V, A, THD, etc.	pulse/Mbus	no
SDM630-MT V2	kWh/kVarh, kW/kVar, kVA, P, F, PF, dmd, V, A, THD, etc.	pulse/Modbus	4 tariffs 10 segments

Two pulse output indicate real-time energy measurement. An RS485/Mbus output allows remote monitoring from another display or a computer.

1.2 RS485 Serial-Modbus RTU

*Not for SDM630-Pulse V2 and SDM630Mbus V2

RS485 serial port with Modbus RTU protocol to provide a means of remotely monitoring and controlling the Unit. Set-up screens are provided for setting up the RS485 port.

1.3 Mbus

*For SDM630-Mbus V2 only

This uses an Mbus port with EN13757-3 protocol to provide a means of remotely monitoring and controlling the Unit. Screens are provided for setting up the RS485 port. Set-up screens are provided for setting up the Mbus port.

1.4 Pulse output

Two pulse outputs that pulse measured active and reactive energy. The constant of pulse output 2 for active energy is 400imp/kWh (unconfigurable), its width is fixed at 100ms. The default constant of configurable pulse output 1 is 400imp/kWh, default pulse width is 100ms. The configurable pulse output 1 can be set from the set-up menu.

2. Start Up Screens

	The first screen lights up all display segments and can be used as a display check.
--	---

	Software version information
--	------------------------------

	The interface performs a self-test and indicates the result if the test passes.
--	---

*After a short delay, the screen will display active energy interface as follows:

	Total active energy in kWh.
--	-----------------------------

3. Measurements

The buttons operate as follows:

	Selects the Voltage and Current display screens. In Set-up Mode, this is the "Left" or "Back" button.
	Select the Frequency and Power factor display screens. In Set-up Mode, this is the "Up" button.
	Select the Power display screens. In Set-up Mode, this is the "Down" button.
	Select the Energy display screens. In Set-up mode, this is the "Enter" or "Right" button.

3.1 Voltage and Current

*Not for SDM630-Standard V2.

Each successive press of the button selects a new parameter:

	Phase to neutral voltages.
	Current on each phase.
	Phase to neutral voltage THD% of 2nd to 19th.
	Each phase Current THD% of 2nd to 19th.

3.2 Frequency and Power Factor and Demand

*Not for SDM630-Standard V2

Each successive press of the button selects a new range:

	Frequency and Power Factor (total).
	Power Factor of each phase.
	Maximum Power Demand.
	Maximum Current Demand.

3.3 Power

*Not for SDM630-Standard V2

Each successive press of the button select a new range:

	Instantaneous Active Power in kW.
	Instantaneous Reactive Power in kVar.
	Instantaneous Volt-Amps in KVA.
	Total kW, kVarh, kVA.

3.4 Energy Measurements

Each successive press of the button selects a new range:

	Import active energy in kWh.
	Export active energy in kWh.
	Tariff 1 active energy Tariff 2 active energy Tariff 3 active energy Tariff 4 active energy *For SDM630-MT V2 only
	Total active energy in kWh.
	Import reactive energy
	Export reactive energy

	Tariff 1 reactive energy Tariff 2 reactive energy Tariff 3 reactive energy Tariff 4 reactive energy *For SDM630-MT V2 only
	Total reactive energy
	date Year/month/day. 1st, Jan, 2000 (default) *For SDM630-MT V2 only
	Time Hour/minute/second Example: 00:02:16 *For SDM630-MT V2 only

*The parameters of date and time can only be set via RS485 communication.

4. Set Up

To enter set-up mode, press the button for 3 seconds, until the password screen appears.

	Setting up is password-protected so you must enter the correct password (default '1000') before processing.
	If an incorrect password is entered, the display will show: PASS Err

To exit setting-up mode, press repeatedly until the measurement screen is restored.

4.1 Set-up Entry Methods

Some menu items, such as password, require a four-digits number entry while others, such as supply system, require selection from a number of menu options.

4.1.1 Menu Option Selection

- Use the and buttons to scroll through the different options of the set up menu.
- Press to confirm your selection
- If an item flashes, then it can be adjusted by the and buttons.
- Having selected an option from the current layer, press to confirm your selection. The SET indicator will appear.
- Having completed a parameter setting, press to return to a higher menu level. The SET indicator will be removed and you will be able to use the and buttons for further menu selection.
- On completion of all setting-up, press repeatedly until the measurement screen is restored.

4.1.2 Number Entry Procedure

When setting up the unit, some screens require the entering of a number. In particular, on entry to the setting up section, a password must be entered. Digits are set individually, from left to right. The procedure is as follows:

- The current digit to be set flashes and is set using the and buttons
- Press to confirm each digit setting. The SET indicator appears after the last digit has been set.
- After setting the last digit, press to exit the number setting routine. The SET indicator will be removed.

4.2 Change Password

	Use the and buttons to choose the change password option.
	Press the to enter the change password routine. The new password screen will appear with the first digit flashing.
	Use and to set the first digit and press to confirm your selection. The next digit will flash.
	Repeat the procedure for the remaining three digits.
	After setting the last digit, SET will show.

Press to exit the number setting routine and return to the Set-up menu. SET will be removed

4.3 DIT Demand Integration Time

*Not for SDM630-Standard V2

This sets the period in minutes over which the current and power readings are integrated for maximum demand measurement. The options are: 0, 5, 8, 10, 15, 20, 30, 60 minutes.

	From the set-up menu, use and buttons to select the DIT option. The screen will show the currently selected integration time.
	Press to enter the selection routine. The current time interval will flash.
	Use and buttons to select the time required.
	Press to confirm the selection. SET indicator will appear.

Press to exit the DIT selection routine and return to the menu.

4.4 Supply System

The unit has a default setting of 3Phase 4wire (3P4).

Use this section to set the type of electrical system.

	From the set-up menu, use and buttons to select the system option. The screen will show the currently selected power supply.
	Press to enter the selection routine. The current selection will flash.
	Use and buttons to select the required system option: 1P2 (W), 3P3 (W), 3P4 (W).
	Press to confirm the selection. SET indicator will appear.

Press to exit the system selection routine and return to the menu. SET will disappear and you will be returned to the main set-up Menu.

4.5 Backlit set-up

Backlit lasting time is settable, default lasting time is 60minutes

	If it's setted as 5, the backlit will be off in 5 minutes if there is no more further operation.
	Press to enter the selection routine. The current time interval will flash. The options are: 0 (always on), 5/10/30/60/120

Press and to select the time interval. Then press to confirm the set-up.

4.6 Pulse Output

This option allows you to configure the pulse output 1. The output can be set to provide a pulse for a defined amount of energy active or reactive. Use this section to set up the pulse output for:

- Total kWh/Total kVarh
- Import kWh/Export kWh
- Import KVarh/Export KVarh

	From the set-up menu, use and buttons to select the Pulse output option.
	Press to enter the selection routine. The unit symbol will flash.
	Use and buttons to choose kWh or kVarh.

On completion of the entry procedure, press to confirm the setting and press to return to the main set up menu.

Warnings

Important Safety Information is contained in the Maintenance section. Familiarize yourself with this information before attempting installation or other procedures. Symbols used in this document:

- Risk of Danger: These instructions contain important safety information. Read them before starting installation or servicing of the equipment.
- Caution: Risk of Electric Shock

4.6.1 Pulse rate

Use this to set the energy represented by each pulse.
Rate can be set to 1 pulse per dFt/0.01/0.1/1/10/100 kWh/kVarh.



(It shows 1 pulse = 10kWh/kVarh)



From the set-up menu, use **↑** and **↓** buttons to select the Pulse Rate option.



Press **↵** to enter the selection routine. The current setting will flash. When it's dFt (default), it means 2.5Wh/Varh.

Use **↑** and **↓** buttons to choose pulse rate.

On completion of the entry procedure, press **↵** to confirm the setting and press **↵/ESC** to return to the main set up menu.

4.6.2 Pulse Duration

The pulse width can be selected as 200 (non-MID version meters only), 100 (default) or 60ms.



(It shows pulse width of 100ms)



From the set-up menu, use **↑** and **↓** buttons to select the Pulse width option.



Press **↵** to enter the selection routine. The current setting will flash.

Use **↑** and **↓** buttons to choose pulse width.

On completion of the entry procedure press **↵** to confirm the setting and press **↵/ESC** to return to the main set up menu.

4.7 Communication

*Not for SDM630-Pulse V2

There is RS485/Mbus port can be used for communication Modbus RTU protocol. For Modbus RTU, parameters are selected from front panel.

4.7.1 RS485 Address

*For SDM630-MT/-Standard/-Modbus V2 only



(The range is from 001 to 247)



From the set-up menu, use **↑** and **↓** buttons to select the address ID.



Press **↵** button to enter the selection routine. The current setting will be flashing.



Use **↑** and **↓** buttons to choose Modbus address (001 to 247).

On completion of the entry procedure, press **↵** button to confirm the setting and press **↵/ESC** button to return the main set-up menu.

4.7.2 Mbus address

*For SDM630-Mbus V2 only



Primary address: 001 to 250 Use **↑** and **↓** buttons to select the address value.



Press **↵** to enter the selection routine. The current setting will flash.



Secondary address: 00 00 00 01 to 99 99 99 99

On completion of the entry procedure, press **↵** to confirm the setting and press **↵/ESC** to return to the main set up menu.

4.7.3 Baud Rate



From the set-up menu, use **↑** and **↓** buttons to select the Baud Rate option.



Press **↵** to enter the selection routine. The current setting will flash.



Use **↑** and **↓** buttons to choose Baud rate.

On completion of the entry procedure, press **↵** to confirm the setting and press **↵/ESC** to return to the main set up menu.

4.7.4 Parity



From the set-up menu, use **↑** and **↓** buttons to select the parity option.



Press **↵** to enter the selection routine. The current setting will flash.



Use **↑** and **↓** buttons to choose parity (EVEN / ODD / NONE).

On completion of the entry procedure, press **↵** to confirm the setting and press **↵/ESC** to return to the main set up menu.

4.7.5 Stop bits

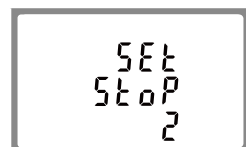

From the set-up menu, use **↑** and **↓** buttons to select the stop bit option.



Press **↵** to enter the selection routine. The current setting will flash.



Use **↑** and **↓** buttons to choose stop bit (2 or 1).
Note: Default is 1, and only when the parity is NONE that the stop bit can be changed to 2.

On completion of the entry procedure, press **↵** to confirm the setting and press **↵/ESC** to return to the main set up menu.

4.8 CLR

*Not for SDM630-Standard V2

The meter provides a function to reset the maximum demand value of current and power.

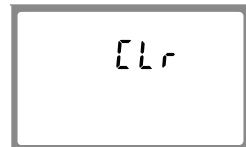

From the set-up menu, use **↑** and **↓** buttons to select the reset option.

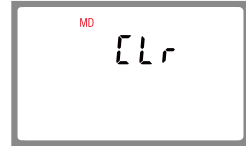

Press **↵** to enter the selection routine. The MD will flash.

Press **↵** to confirm the setting and press **↵/ESC** to return to the main set up menu.

5. Specifications

5.1 Measured Parameters

The unit can monitor and display the following parameters of a single phase two wire (1p2w), three phase three wire (3p3w) and three phase four wire (3p4w) system.

5.1.1 Voltage and Current

*Not for SDM630-Standard V2

- Phase to neutral voltages 100 to 289V a.c. (not for 3p3w supplies).
- Voltages between phases 173 to 500V a.c. (3p supplies only).
- Percentage total voltage harmonic distortion (THD%) for each phase to N (not for 3p3w supplies).
- Percentage voltage THD% between phases (three phase supplies only).
- Current THD% for each phase

5.1.2 Power factor and Frequency and Max. Demand

*Not for SDM630-Standard V2

- Frequency in Hz
- Instantaneous power:
- Power 0 to 99999 W
- Reactive power 0 to 99999 Var
- Volt-amps 0 to 99999 VA
- Maximum demanded power since last Demand reset
- Power factor
- Maximum neutral demand current, since the last Demand reset (for three phase supplies only)

5.1.3 Energy Measurements

- Import active energy 0 to 999999.99 kWh
- Export reactive energy 0 to 999999.99 kVarh
- Import active energy 0 to 999999.99 kWh
- Export reactive energy 0 to 999999.99 kVarh
- Total active energy 0 to 999999.99 kWh
- Total reactive energy 0 to 999999.99 kVarh

5.2 Measured Inputs

Voltage inputs through 4-way fixed connector with 25mm² stranded wire capacity. single phase two wire (1p2w), three phase three wire (3p3w) or three phase four wire (3p4w) unbalanced. Line frequency measured from L1 voltage or L3 voltage.

5.3 Interfaces for External Monitoring

Three interfaces are provided:

- RS485 / Mbus communication channel that can be programmed via protocol remotely. (not for SDM630-Pulse V2)
- Pulse output (pulse1) indicating real-time measured energy. (configurable)
- Pulse output (pulse2) 400imp/kWh (not configurable)

The Modbus/Mbus configuration (baud rate etc) and the pulse relay output assignments (kWh/kVarh, import/export etc) are configured through the set-up screens.

5.3.1 Pulse Output

The pulse output can be set to generate pulses to represent kWh or kVarh.

Rate can be set to generate 1 pulse per:

- dFt (default) = 2.5 Wh/Varh
- 0.01 = 10 Wh/Varh
- 0.1 = 100 Wh/Varh
- 1 = 1 kWh/kVarh
- 10 = 10 kWh/kVarh
- 100 = 100 kWh/kVarh

Pulse width 200/100/60 ms.
Pulse output 2 is non-configurable. It is fixed up with active kWh. Its constant is 400imp/kWh.

5.3.2 RS485/Mbus Output for Modbus RTU

*For SDM630-MT/-Modbus/-Standard V2 only

For Modbus RTU, the following RS485 communication parameters can be configured from the set-up menu:

- Baud rate 2400, 4800, 9600, 19200, 38400
- Parity none / odd / even
- Stop bits 1 or 2
- RS485 network address nnn – 3-digit number, 001 to 247

*For SDM630-Mbus V2 only

For Mbus, the following communication parameters can be configured from the set-up menu:

- Baud rate 300,600,2400, 4800, 9600
- Parity none/ odd / even
- Stop bits 1 or 2
- Mbus network primary address nnn – 3-digit number, 001 to 250
- Mbus network secondary address 00 00 00 00 to 99 99 99 99

*If the Modbus/Mbus protocol document is required, please contact us for it.

5.4 Accuracy

- Voltage 0.5% of range maximum
- Current 0.5% of nominal
- Frequency 0.2% of mid-frequency
- Power factor 1% of unity (0.01)
- Active power (W) ±1% of range maximum
- Reactive power (VAR) ±1% of range maximum
- Apparent power (VA) ±1% of range maximum
- Active energy (Wh) Class 1 IEC 62053-21 Class B EN50470-3 ±1% of range maximum
- Reactive energy (VARh) ±1% of range maximum
- Response time to step input 1s, typical, to >99% of final reading, at 50 Hz.

5.5 Reference Conditions of Influence Quantities

Influence Quantities are variables that affect measurement errors to a minor degree. Accuracy is verified under nominal value (within the specified tolerance) of these conditions.

- Ambient temperature 23°C ± 2°C
- Input frequency 50 Hz (MID) 50 or 60Hz ±2% (non-MID)
- Input waveform Sinusoidal (distortion factor < 0.005)
- Magnetic field of external origin Terrestrial flux

5.6 Environment

- Operating temperature -25°C to +55°C*
- Storage temperature -40°C to +70°C*
- Relative humidity 0 to 95%, non-condensing
- Altitude Up to 2000m
- Warm up time 1 minute
- Vibration 10Hz to 50Hz, IEC 60068-2-6, 2g
- Shock 30g in 3 planes

* Maximum operating and storage temperatures are in the context of typical daily and seasonal variation.

5.7 Mechanics

- DIN rail dimensions 72 x 100 mm (WxH) per DIN 43880
- Mounting DIN rail (DIN 43880)
- Sealing IP51 (indoor)
- Material Self-extinguishing UI94 V-0

5.8 Declaration of Conformity (for the MID approved version meter only)

We Jiaying Eastron Electronic Instruments Co., Ltd. Declare under our sole responsibility as the manufacturer that the poly phase multifunction electrical meter "SDM630 100A V2 series" correspond to the production model described in the EC-type examination certificate and to the requirements of the Directive 2014/32/EU EC type examination certificate number 0120/SGS0151. Identification number of the NB0120

6. Dimensions

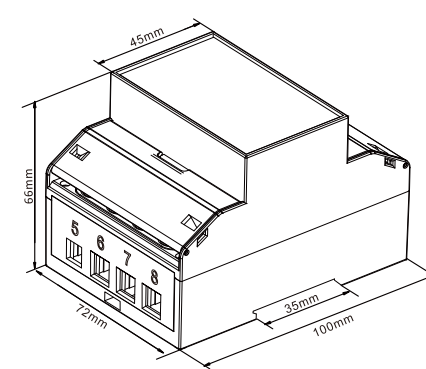

7. Wiring diagram

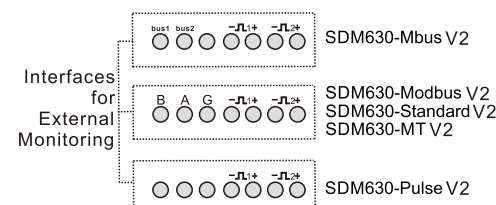

7.1 single phase two wires

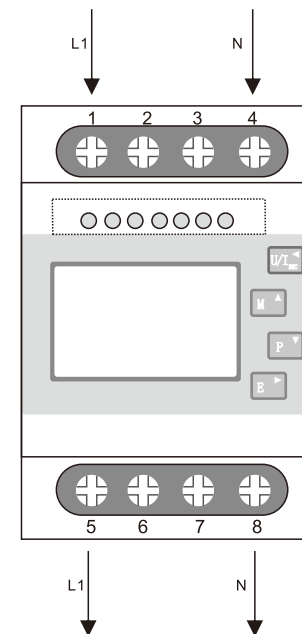

7.2 three phase three wires

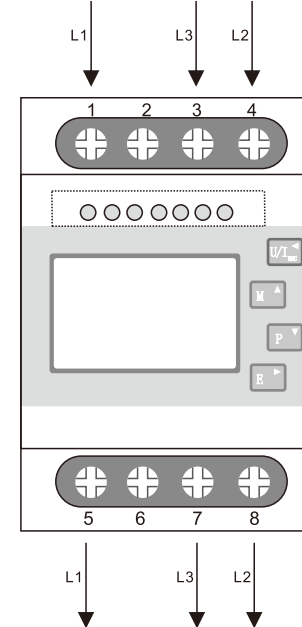

7.3 three phase four wires

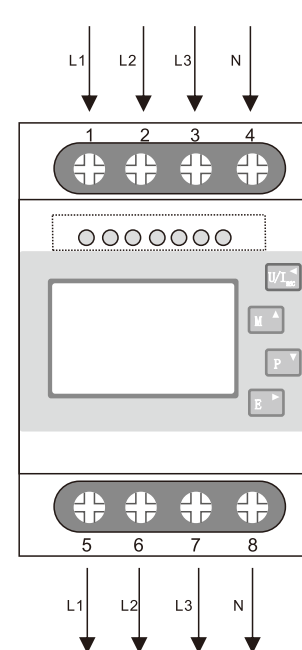

Jiaying Eastron Electronic Instruments Co., Ltd.
No.1369, Chengnan Rd.
Jiaying, Zhejiang, China
Tel: 86 573 83698881/83698882
Tel: 86 573 83698883
Email: sales@eastrongroup.com
Web: www.eastrongroup.com

